











































Victory Series™ Low Profile MBT™ Versatile+ Appliance System

011-587-3

024-812 024-912  NO INK -7° T 0° A 2nd BI w/hk (THK)	024-584 024-684  YELLOW -7° T 0° A Bicuspid w/hk	024-882 024-982  RED -7° T +8° A Cuspid w/hook	024-774 024-874  RED 0° T +8° A Cuspid w/hook	Gingival				024-773 024-873  BLUE 0° T Cuspid w/hook	024-881 024-981  BLUE -7° T +8° A Cuspid w/hook	024-585 024-685  YELLOW -7° T 0° A Bicuspid w/hk	024-813 024-913  NO INK -7° T +2° A 2nd BI w/hk (THK)
024-791 024-891  NO INK -7° T 0° A 2nd BI (THK)	024-790 024-890  YELLOW -7° T 0° A Univ BI	024-780 024-880  RED -7° T +8° A Cuspid	024-370 024-470  RED 0° T +8° A Cuspid	024-778 024-878  RED +10° T +8° A Lateral	024-776 024-876  RED +17° T +4° A Central	024-775 024-875  BLUE +17° T +4° A Central	024-777 024-877  BLUE +10° T +8° A Lateral	024-369 024-469  BLUE 0° T Cuspid	024-779 024-879  BLUE -7° T +8° A Cuspid	024-790 024-890  YELLOW -7° T 0° A Univ BI	024-791 024-891  NO INK -7° T 0° A 2nd BI (THK)
<i>Patient's Right</i>				Occlusal				<i>Patient's Left</i>			
024-798 024-898  BLACK -17° T +2° A 2nd Bicuspid	024-796 024-896  BLACK -12° T +2° A 1st Bicuspid	024-7941 024-8941  BLACK -6° T +3° A, +2° DO Cuspid	024-3821 024-4821  BLACK 0° T +3° A, +2° DO Cuspid	024-792 024-892  NO INK -6° T 0° A Anterior	024-792 024-892  NO INK -6° T 0° A Anterior	024-792 024-892  NO INK -6° T 0° A Anterior	024-792 024-892  NO INK -6° T 0° A Anterior	024-3811 024-4811  CREME 0° T +3° A, +2° DO Cuspid	024-7931 024-8931  CREME 0° T +3° A, +2° DO Cuspid	024-795 024-895  CREME -12° T +2° A 1st Bicuspid	024-797 024-897  CREME -17° T +2° A 2nd Bicuspid
024-810 024-910  BLACK -17° T +2° A 2nd Bicuspid w/hk	024-808 024-908  BLACK -12° T +2° A 1st Bicuspid w/hk	024-8841 024-9841  BLACK -6° T +3° A, +2° DO Cuspid w/hook	024-7721 024-8721  BLACK 0° T +3° A, +2° DO Cuspid w/hook	 Standard Base		 Offset Base		024-7711 024-8711  CREME 0° T +3° A, +2° DO Cuspid w/hook	024-8831 024-9831  CREME -6° T +3° A, +2° DO Cuspid w/hook	024-809 024-909  CREME -12° T +2° A 1st Bicuspid w/hk	024-811 024-911  CREME -17° T +2° A 2nd Bicuspid w/hk
<p>Bicuspid Base Options</p> <p>Bicuspid Brackets are available on "Standard Base" or "Offset Base"</p>											

Identification Information

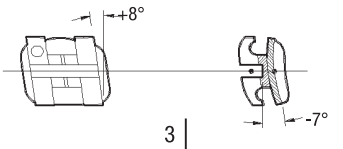
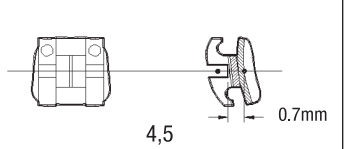
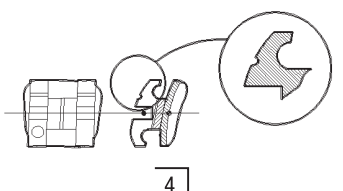
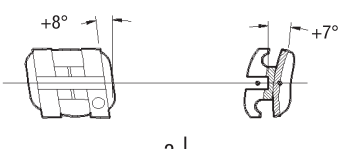
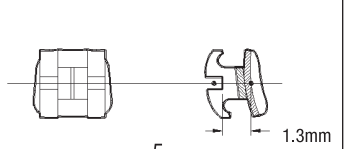
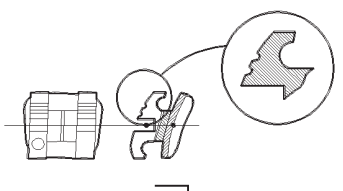
Labial Root Torque			
Lingual Root Torque		Thick Base 	

3M
3M Unitek
Orthodontic Products
 2724 South Peck Road
 Monrovia, CA 91016 USA

EC REP **CE** 0086
3M Deutschland GmbH
Orthodontic Products
 Carl-Schurz-Str. 1
 D-41453 Neuss, Germany
 +49/(0)8191/ 9474-0

5	4	3	2	1	1	2	3	4	5
5	4	3	2	1	1	2	3	4	5

© 2004, 2010, 2012 3M. All rights reserved.
 REF 011-587-3 1206