

3M
Ranger™
Blood/Fluid Warming Unit,
Model 245
Service Manual
For I.V. Use

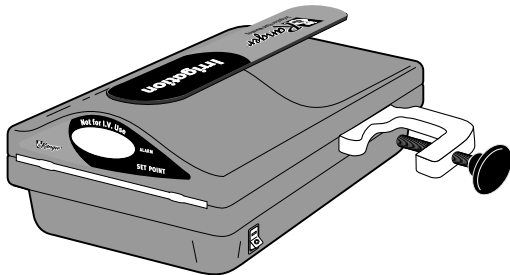

3M
Ranger™
Blood/Fluid Warming Unit,
Model 247
Service Manual
Not for I.V. Use

Ⓒ Model 245 • Blood/Fluid Warming Unit
• For I.V. Use

Ⓒ Model 247 • Irrigation Fluid Warming Unit
• Not for I.V. Use

Ⓓ Modell 245 • Blut-/Infusionserwärmungseinheit
• für intravenöse Anwendungen

Ⓓ Modell 247 • Spülflüssigkeitserwärmungseinheit
• Nicht für intravenöse Anwendungen

Ⓕ Modèle 245 • Appareil de réchauffement de
sang/soluté
• Pour perfusion I.V

Ⓕ Modèle 247 • Appareil de réchauffement pour
liquide d'irrigation
• Ne pas utiliser pour une perfusion I.V

Service Manual 2

Wartungshandbuch 23

Manuel d'entretien 47



Ranger™

Blood and Fluid Warming Systems

Table of Contents

Technical Service and Order Placement.....	3
In-warranty Repair and Exchange.....	3
When You Call for Technical Support	3
Initial Equipment Check.....	3
Introduction.....	4
Model 245 Blood/Fluid Warming System.....	4
Model 247 Irrigation Fluid Warming System	4
Indications for Use.....	4
Definition of Symbols.....	4
Explanation of Signal Word Consequences.....	6
Warnings and Cautions	6
Before Servicing Equipment.....	7
Product Description	8
Ranger Warming Unit	8
Ranger Models 245 and 247	9
Maintenance and Storage	10
Blood/Fluid Warming System Preventative Maintenance Checklist	12
Ranger Blood/Fluid Warming Unit, Model 245 Maintenance Log	15
Ranger Irrigation Fluid Warming System, Model 247 Preventative Maintenance Checklist.....	16
Ranger Irrigation Fluid Warming, Model 247 Maintenance Log	18
Replacing the Power Fuse	19
Troubleshooting.....	20
Specifications.....	22

Technical Service and Order Placement

USA

TEL: 1-800-228-3957

Outside of the USA

Contact your local 3M representative.

IN-WARRANTY REPAIR AND EXCHANGE

To return a device to 3M for service, first obtain a Return Authorization (RA) number from a customer service representative. Please use the (RA) number on all correspondence when returning a device for service. A shipping carton will be delivered to you at no charge, if needed. Call your local supplier or sales representative to inquire about a loaner device while your device is being serviced.

WHEN YOU CALL FOR TECHNICAL SUPPORT

Remember, we will need to know the serial number of your unit when you call us. The serial number label is located on the bottom of the warming unit.

Initial Equipment Check

- Make sure the 3M™ Ranger™ warming unit's power cord is plugged into the unit.
- When checking for grounding, clamp to the screw threads on the unit's I.V. pole clamp or the equipotential stud on the rear of the unit. Clamp should be tightened securely.
- Sometime during shipping, this unit may have been exposed to extreme temperatures. The unit may need a period of 20 minutes or more to return to normal operating temperature. Store the Ranger warming unit at room temperature, allowing it to equilibrate, before using or testing the unit.

Introduction

The Ranger warming system includes a warming unit and a disposable warming set. The Ranger warming unit is designed to be mounted to an I.V. pole. A handle located on the top of the unit makes transport easy. When mounted to the I.V. pole, the unit fits easily above the 3M™ Bair Hugger™ 500 or 700 series warming unit. For additional information on Ranger warming sets visit us online at rangerfluidwarming.com.

MODEL 245 BLOOD/FLUID WARMING SYSTEM

The Ranger blood/fluid warming system is designed to warm blood, blood products, and liquids and deliver these at flow rates from KVO to 500 mL/min. At these flow rates, the device maintains fluid output temperatures ranging from 33°C to 41°C (Note: This is for room temperature fluids only). It takes less than two minutes to warm up to the 41°C ±1 set point temperature. The alert points on the Model 245 are 43°C ±1 and 46°C [+3, -2°C].

Disposable warming sets are available for standard flow, high flow, and pediatric applications. Warming sets are sterile, latex-free, single-use-only items and are designed to be used with the reusable warming unit. Do not use other warming sets with the Model 245, including those designed for the Model 247 irrigation fluid warming system.

MODEL 247 IRRIGATION FLUID WARMING SYSTEM

The Ranger irrigation fluid warming system is designed to warm irrigation fluids and deliver these at flow rates from 0 to 865 mL/min when the bag is hung 100 cm above the scope. At these flow rates, the device maintains fluid output temperatures ranging from 33°C to 41°C (Note: This is for room temperature fluids only). It takes less than two minutes to warm up to the 41°C ±1 set point temperature. The alert points on the Model 247 are 48°C (±2) and 50°C (±2).

The Ranger irrigation disposable fluid warming set is sterile, latex-free, and is designed to be used with the Ranger irrigation fluid warming unit. Do not use other warming sets with the Model 247, including those designed for the Model 245 blood/fluid warming unit.

INDICATIONS FOR USE

BLOOD/FLUID WARMING SYSTEM

The Ranger blood/fluid warming system is intended to warm blood, blood products, and liquids.

IRRIGATION FLUID WARMING SYSTEM

The Ranger irrigation fluid warming system is intended to warm irrigation fluids.

DEFINITION OF SYMBOLS



ON



OFF



















Fuse



CAUTION

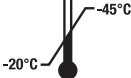

Type BF Applied Part

	Voltage, Alternating Current (AC)
	An equipotentiality plug (grounded) conductor other than a protective earth conductor or a neutral conductor, providing a direct connection between electrical equipment and the potential equalization busbar of the electrical installation. Please consult IEC 60601-1; 2005 for requirements.
 	This system is subject to European WEEE Directive 2002/96/EC. This product contains electrical and electronic components and must not be disposed of using standard refuse collection. Please consult local directives for disposal of electrical and electronic equipment.
	Protective earth ground
	Consult instructions for use
	Follow instructions for use
	Recycle to avoid environmental contamination. This product contains recyclable parts. For information on recycling - please contact your nearest 3M Service Center for advice.
	Date of manufacture
	Manufacturer
	Sterile, ethylene oxide
 <small>Store at room temperature</small>	Store at room temperature
	DEHP-free
	Container quantity
	Single use
	Latex free
	Keep dry
	Temperature limits

EXPLANATION OF SIGNAL WORD CONSEQUENCES



WARNING:

Indicates a hazardous situation which, if not avoided, could result in death or serious injury.



CAUTION:

Indicates a hazardous situation which, if not avoided, could result in minor or moderate injury.

NOTICE:

Indicates a situation which, if not avoided, could result in property damage only.



WARNINGS AND CAUTIONS

WARNINGS:

1. To reduce the risks associated with hazardous voltage and fire and thermal energy hazards:
 - Do not substitute other devices (i.e. Model 245) for the Ranger irrigation fluid warming unit or Ranger irrigation warming sets.
2. To reduce the risks associated with hazardous voltage and fire:
 - Do not modify this device.
 - Connect power cord to receptacles marked “Hospital Only,” “Hospital Grade,” or a reliably grounded outlet.
 - Use only the power cord specified for the product and certified for the country of use.
 - Do not allow the power cord to get wet.
 - Do not use the warming unit when it appears the Ranger warming unit, power cord, or warming set is damaged. Use only 3M specified replacement parts.
 - Keep power cord visible and accessible at all times. The plug on the power cord serves as the disconnect device. The wall socket outlet shall be as close as practical and shall be easily accessible.



CAUTION:

1. To reduce the risks associated with cross-contamination:
 - The cleaning tool provides only superficial cleaning, it does not disinfect or sterilize the interior of the unit.
2. To reduce the risks associated with impact and facility medical device damage:
 - Clamp the Ranger warming unit to an I.V. pole with a minimum 14" (35.6 cm) radius wheelbase and at a height no higher than 44" (112 cm).
3. To reduce the risks associated with environmental contamination:
 - Follow applicable regulations when disposing of this device or any of its electronic components.
4. Do not use the Ranger blood/fluid warming system Model 245 for direct cardiac application. When using the Model 245 with a central venous catheter (CVC), ensure that the catheter tip does not have direct contact with the heart and ensure that all electrical devices connected to or near the patient have an appropriate leakage current rating for the application. If a CVC tip is found to be in direct contact with a patient's heart, the Model 245 should be immediately disconnected from the CVC until the CVC is safely repositioned. Failure to follow these precautions may cause cardiac disturbance and/or patient injury.
5. Follow the AABB Guidelines for the use of blood warming device which caution against warming when administering platelets, cryoprecipitates, or granulocyte suspensions.

NOTICE:

1. Federal law (USA) restricts this device to sale by or on the order of a licensed healthcare professional.
2. To avoid device damage:
 - Do not clean the warming unit with solvents. Damage to the case, label, and internal components may result.
 - Do not immerse the warming unit in cleaning or sterilizing solutions. The unit is not liquid proof.
 - Do not insert metallic instruments in the warming unit.
 - Do not use abrasive materials or solutions to clean the heater plates.
 - Do not allow spills to dry inside the unit, as this may make it more difficult to clean the unit.
3. The Ranger blood/fluid warming unit and irrigation fluid warming unit meet medical electronic interference requirements. If radio frequency interference with other equipment should occur, connect the unit to a different power source.

BEFORE SERVICING EQUIPMENT

All repair, calibration, and servicing of this equipment must be performed by 3M Patient Warming or an authorized service technician. 3M Patient Warming assumes no responsibility for the reliability, performance, or safety of the equipment if:

- Modifications or repairs are performed by unauthorized personnel.
- The equipment is used in a manner other than that described in the operator's manual.
- The equipment is installed in an environment that does not meet the appropriate electrical and grounding requirements.
- Do not modify this equipment without authorization of the manufacturer.

**WARNING:**

- To reduce the risk associated with exposure to biohazards always perform the *Cleaning the Ranger warming unit* procedure on page 10 prior to beginning service procedures, returning the warming unit for service, and prior to disposal.

Product Description

The Ranger blood/fluid, and irrigation fluid warming systems consist of a warming unit and a sterile disposable fluid warming set.

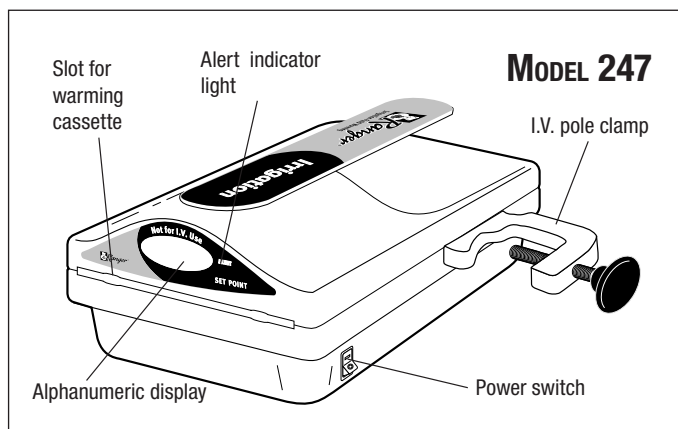
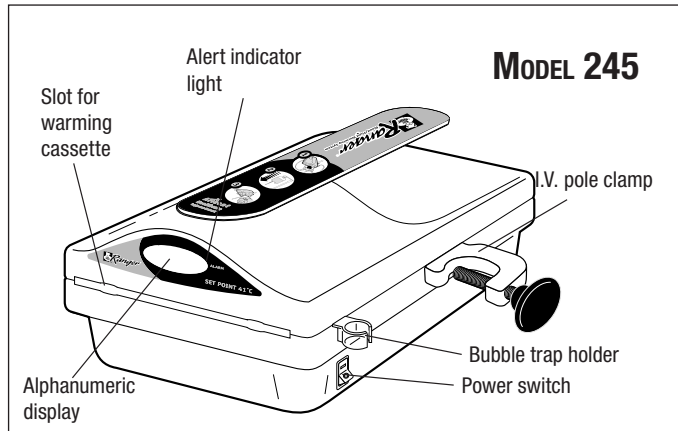

RANGER WARMING UNIT

The warming unit is a compact, lightweight, liquid-resistant device with a clamp located on the side for attachment to an I.V. pole. A carrying handle on the top of the unit makes it easy to transport.

Located on the front panel you will find:

- Alphanumeric display that indicates the heater temperature during normal operation. In an over-temperature condition, the display alternately flashes a temperature of 43°C for the Model 245 (48°C for the Model 247) or higher and the word “HI.” An audible alert also sounds. In an under-temperature condition, the display alternately flashes a temperature of 33°C or lower and the word “LO.”
- Alert indicator light that comes on when either an over- or under-temperature condition occurs.

Ranger Models 245 and 247

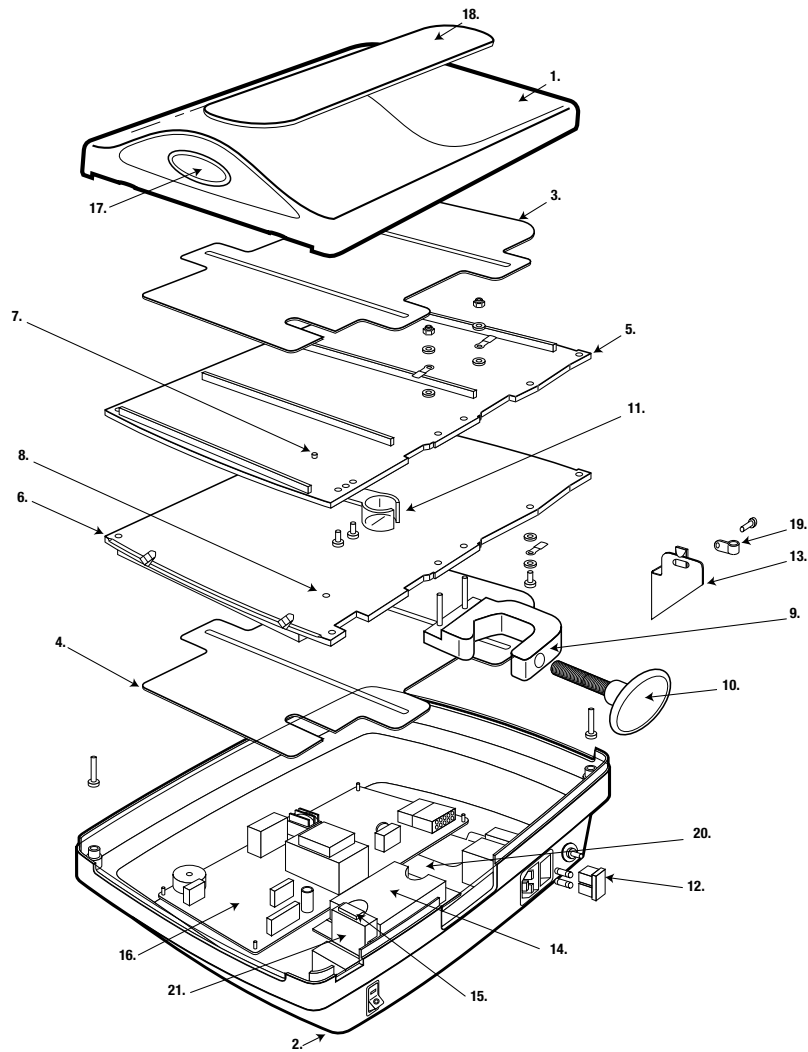

- | | | |
|-----------------------|---------------------------------------|------------------|
| 1. Upper Enclosure | 8. Thermistor Sensor | 15. Microswitch |
| 2. Lower Enclosure | 9. Pole Clamp | 16. Alarm Board |
| 3. Upper Heater | 10. Pole Clamp Knob | 17. Controller |
| 4. Lower Heater | 11. Bubble Trap Holder
(Model 245) | 18. Handle |
| 5. Upper Heater Plate | 12. Power Entry Module | 19. Cable Clamp |
| 6. Lower Heater Plate | 13. Cord Retainer | 20. Ground Plane |
| 7. RTD Sensor | 14. Solid State Relay | 21. Heat Sink |

Maintenance and Storage

CLEANING THE RANGER WARMING UNIT

Clean the Ranger warming unit on an as-needed basis.



CAUTION

1. To reduce the risks associated with cross-contamination:
 - The cleaning tool provides only superficial cleaning, it does not disinfect or sterilize the interior of the unit.

NOTICE

1. To avoid device damage:
 - Do not immerse the warming unit in cleaning or sterilizing solutions. The unit is not liquid proof.
 - Do not clean the warming unit with solvents. Damage to the case, label, and internal components may result.
 - Do not insert metallic instruments in the warming unit.
 - Do not use abrasive materials or solutions to clean the heater plates.
 - Do not allow spills to dry inside the unit, as this may make it more difficult to clean the unit.

TO CLEAN THE EXTERIOR OF THE WARMING UNIT:

1. Disconnect the Ranger warming unit from the power source.
2. Wipe the outside of the unit with warm, soapy water, nonabrasive cleaning solutions, dilute bleach, or cold sterilants. Do not use abrasive materials.
3. Wipe with a dry, soft cloth.

TO CLEAN THE HEATING PLATES:

The Ranger warming unit cleaning tool is intended to clean both heating plates of the warming unit. It is not necessary to disassemble the warming unit to use the tool.

METHOD

1. Unplug the warming unit.
2. Unfold the cleaning tool. Wet the foam pads with a nonabrasive solution, such as Alconox™ brand detergent.
3. Insert the tool from the back of the unit and pull the tool all the way out from the front.
4. Rinse the tool with water and repeat 3 times. Discard the tool according to institutional protocol.
5. Wipe off the unit to remove excess fluid.

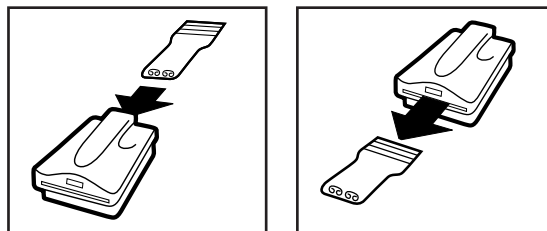
**TO CLEAN RESISTANT, DRIED-ON FLUIDS:**

1. Spray a nonabrasive solution inside the slot of the warming unit and let sit for 15-20 minutes.
2. Clean the unit by using the cleaning tool.

NOTE: You may use a nonmetal instrument, such as a cotton swab, to clean the upper channels. If you are unable to adequately clean the unit, call 3M technical support.

STORAGE

Store all components in a cool, dry place when not in use.

Call 3M technical support at 800-228-3957 for service information.

Alconox is a trademark of Alconox, Inc.

Blood/Fluid Warming System Preventative Maintenance Checklist

CAUTION

Temperature adjustments cannot be made to the Ranger warming unit. If the test shows the temperature is out of specification, please call 3M technical support at 1-800-228-3957.

TOOLS AND EQUIPMENT

- Thermocouple: 0.005" lead or smaller (part #90020)
- Calibrated thermocouple temperature monitor
- Aluminum tape
- Ranger standard flow blood/fluid warming set
- Phillips screwdriver
- Saline/water

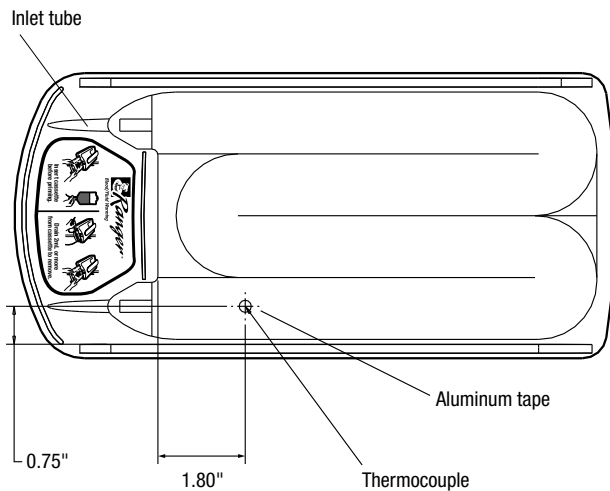

Fig. 1: Ranger standard flow blood/fluid warming cassette

1. Use aluminum tape to affix a thermocouple to the top surface of the Ranger warming as shown in Figure 1.
2. Slide the cassette into the slot of the Ranger warming unit.
3. Using room temperature saline/water, prime the cassette per instructions included with it.
NOTE: To achieve correct results, fluids must be administered into the inlet tube, NOT into the outlet tube.
4. Close patient line with white clamp to stop flow.
5. Turn the Ranger warming unit ON and allow it to warm up for 5 minutes.
6. The Ranger warming unit display should read $41^{\circ}\text{C}\pm 1$. Note the temperature on the thermocouple temperature monitor. If the temperature reading is not $41^{\circ}\text{C}\pm 1$, call 3M Patient Warming technical support.

NOTE: Most handheld temperature meters have a $\pm 1^{\circ}\text{C}$ tolerance.

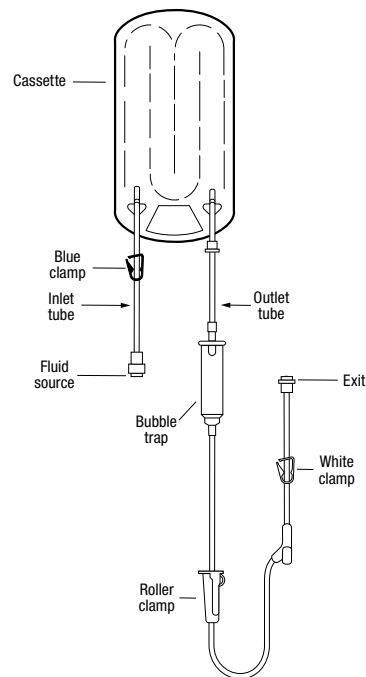

Fig. 2: Ranger standard flow blood/fluid warming set

TESTING THE OVER-TEMPERATURE ALERT POINTS (43°C [±1] AND 46°C [+3, -2])

The over-temperature alert test causes the Ranger warming unit to go into an over-temperature test mode by manually overriding the primary control system and engaging the heaters. The Ranger warming system is very responsive to heater input; therefore the test procedures are technique sensitive. Read instructions thoroughly before beginning these tests.

The first alert point at 43°C (±1) notifies user to the rise in temperature (see step 7). At the 46°C (+3, -2) secondary alert set point, the unit cuts power to the heaters (see step 8). Please note that due to the heaters' rapid response, you may see temperature readings drift within the range of 44-49°C.

- Loosen the over-temperature screw on the bottom of the Ranger warming unit (see Fig. 3). Listen for a slight click as the microswitch opens. **Loosen ½ turn more.** This unit is now in over-temperature test mode, and the temperature output of the unit should begin to rise. When the Ranger display reads 43°C, verify that an audible alert sounds, the alert light illuminates, and the display alternately flashes "HI" and the plate temperature.

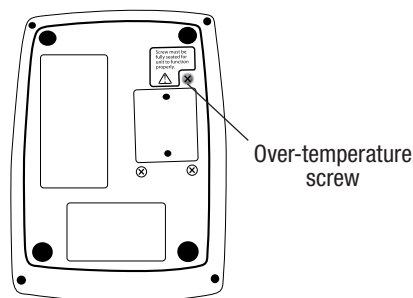

Fig. 3: Ranger warming unit over-temperature screw

- Listen for the power relay to click at 46°C (+3, -2) (you can feel the click when holding the lower left corner of the unit as you face the front display). The click signifies the secondary alert trip point and signals that power to the heaters has been shut off. The over-temperature alert sounds, the alarm light illuminates, and the alphanumeric display alternately reads "HI" and the plate temperature. Watch the thermocouple temperature monitor to determine the unit's peak temperature output (less than 1 minute). The temperature reading on the monitor should peak at 46°C (+3, -2).

NOTE: If the temperature displayed on the thermocouple monitor exceeds 49°C during the test, tighten the over-temperature test screw on the bottom of the Ranger warming unit, unplug it, and run cold fluids through the cassette. This returns the unit to normal operating temperature. Call 3M Patient Warming technical support.

- The secondary alert is designed to latch. Verify this feature by momentarily turning off the power switch, then turning it on again. The Ranger warming unit should continue alerting throughout this sequence.
- Securely tighten the over-temperature screw, turn off the Ranger warming unit, and unplug the unit. Once power is cut to the Ranger warming unit, the alert will cease. The unit is ready to return to service after it cools to normal operating temperature (approximately 20-30 minutes).

Ranger Blood/Fluid Warming Unit, Model 245 Maintenance Log

The operating temperature and alerts should be tested at least every 6 months or according to institutional protocol.

MAINTENANCE ACTION PERFORMED

MODEL _____ SN _____

Date _____	Operating temperature: (Specification = 41°C±1)	_____°C
	Over-temperature alert points:	
	Audible (43°C [±1] on Ranger unit display)	_____°C
	Secondary (46°C [+3, -2])	_____°C
Date _____	Operating temperature: (Specification = 41°C±1)	_____°C
	Over-temperature alert points:	
	Audible (43°C [±1] on Ranger unit display)	_____°C
	Secondary (46°C [+3, -2])	_____°C
Date _____	Operating temperature: (Specification = 41°C±1)	_____°C
	Over-temperature alert points:	
	Audible (43°C [±1] on Ranger unit display)	_____°C
	Secondary (46°C [+3, -2])	_____°C
Date _____	Operating temperature: (Specification = 41°C±1)	_____°C
	Over-temperature alert points:	
	Audible (43°C [±1] on Ranger unit display)	_____°C
	Secondary (46°C [+3, -2])	_____°C
Date _____	Operating temperature: (Specification = 41°C±1)	_____°C
	Over-temperature alert points:	
	Audible (43°C [±1] on Ranger unit display)	_____°C
	Secondary (46°C [+3, -2])	_____°C
Date _____	Operating temperature: (Specification = 41°C±1)	_____°C
	Over-temperature alert points:	
	Audible (43°C [±1] on Ranger unit display)	_____°C
	Secondary (46°C [+3, -2])	_____°C

Model 245

Ranger Irrigation Fluid Warming System, Model 247 Preventative Maintenance Checklist

CAUTION

Temperature adjustments cannot be made to the Ranger irrigation fluid warming unit. If the test shows the temperature is out of specification, please call 3M technical support at 1-800-228-3957.

TOOLS AND EQUIPMENT

- Thermocouple: 0.005" lead or smaller (part #90020)
- Calibrated thermocouple temperature monitor
- Aluminum tape
- Ranger irrigation fluid warming set
- Phillips screwdriver
- Saline/water

1. Use aluminum tape to affix a thermocouple to the top surface of the Ranger irrigation fluid warming cassette as shown in Fig. 1.
2. Slide the warming cassette into the slot of the Ranger irrigation fluid warming unit.
3. Using room temperature saline/water, prime the cassette per instructions included with it.

NOTE: To achieve correct results, fluids must be administered into the inlet tube, NOT into the outlet tube.

4. Close patient line with white clamp to stop flow.
5. Turn the Ranger irrigation warming unit ON and allow it to warm up for 5 minutes.
6. The Ranger irrigation warming unit display should read $41^{\circ}\text{C}\pm 1$. Note the temperature on the thermocouple temperature monitor. If the temperature reading is not $41^{\circ}\text{C}\pm 1$, call 3M Patient Warming technical support.

NOTE: Most handheld temperature meters have a $\pm 1^{\circ}\text{C}$ tolerance.

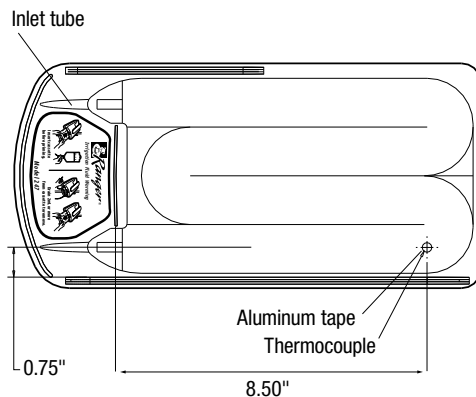
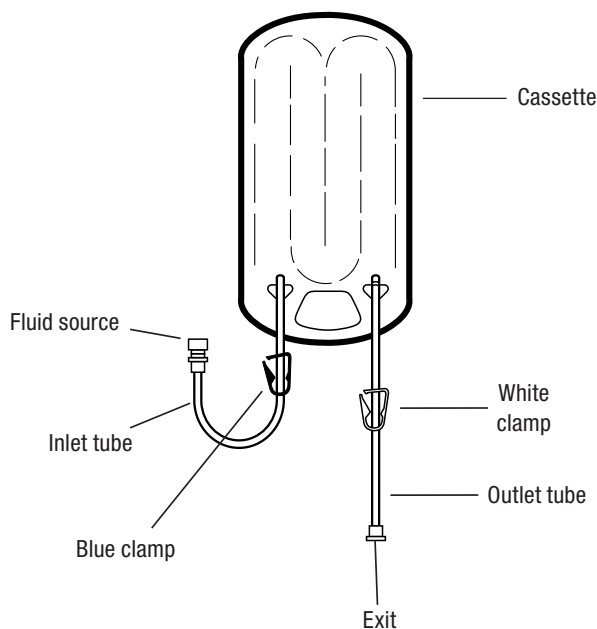

Fig. 1: Ranger irrigation fluid warming cassette

Fig. 2: Ranger irrigation fluid warming set



TESTING THE OVER-TEMPERATURE ALERT POINTS (48°C [±2] AND 50°C [±2])

The over-temperature alert test causes the Ranger irrigation warming unit to go into an over-temperature test mode by manually overriding the primary control system and engaging the heaters. The Ranger irrigation warming system is very responsive to heater input; therefore the test procedures are technique sensitive. Read instructions thoroughly before beginning these tests.

The first alert point at 48°C (±2) notifies user to the rise in temperature (see step 7). At the 50°C (±2) secondary alert set point, the unit cuts power to the heaters (see step 8).

7. Loosen the over-temperature screw on the bottom of the Ranger irrigation unit (see Fig. 3). Listen for a slight click as the microswitch opens. **Loosen ½ turn more.** This unit is now in over-temperature test mode, and the temperature output of the unit should begin to rise. When the display reads 48°C, verify that an audible alert sounds, the alert light illuminates, and the display alternately flashes “HI” and the plate temperature.

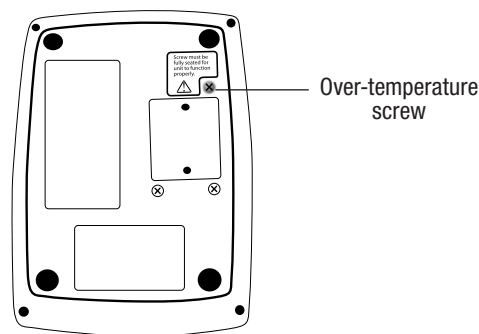

Fig. 3: Ranger irrigation fluid warming unit over-temperature screw

8. Listen for the power relay to click at 50°C (±2) (you can feel the click when holding the lower left corner of the unit as you face the front display). The click signifies the secondary alert trip point and signals that power to the heaters has been shut off. The over-temperature alert sounds, the alert light illuminates, and the alphanumeric display alternately reads “HI” and the plate temperature. Watch the thermocouple temperature monitor to determine the unit’s peak temperature output (less than 1 minute). The temperature reading on the monitor should peak at 50°C (±2).

NOTE: If the temperature displayed on the thermocouple monitor exceeds 52°C during the test, tighten the over-temperature test screw on the bottom of the Ranger irrigation warming unit, unplug it, and run cold fluids through the cassette. This returns the unit to normal operating temperature. Call 3M technical support.

9. The secondary alert is designed to latch. Verify this feature by momentarily turning off the power switch, then turning it on again. The Ranger irrigation warming unit should continue alerting throughout this sequence.
10. Securely tighten the over-temperature screw, turn off the Ranger irrigation warming unit, and unplug the unit. Once power is cut to the Ranger irrigation warming unit, the alert will cease. The unit is ready to return to service after it cools to normal operating temperature (approximately 20-30 minutes).

Ranger Irrigation Fluid Warming, Model 247 Maintenance Log

The operating temperature and alerts should be tested at least every 6 months or according to institutional protocol.

MAINTENANCE ACTION PERFORMED

MODEL _____ SN _____

Date _____ **Operating temperature:** (Specification = 41°C±1) _____°C

Over-temperature alert points:

Audible (48°C [±2] on Ranger unit display) _____°C

Secondary (50°C [±2]) _____°C

Date _____ **Operating temperature:** (Specification = 41°C±1) _____°C

Over-temperature alert points:

Audible (48°C [±2] on Ranger unit display) _____°C

Secondary (50°C [±2]) _____°C

Date _____ **Operating temperature:** (Specification = 41°C±1) _____°C

Over-temperature alert points:

Audible (48°C [±2] on Ranger unit display) _____°C

Secondary (50°C [±2]) _____°C

Date _____ **Operating temperature:** (Specification = 41°C±1) _____°C

Over-temperature alert points:

Audible (48°C [±2] on Ranger unit display) _____°C

Secondary (50°C [±2]) _____°C

Date _____ **Operating temperature:** (Specification = 41°C±1) _____°C

Over-temperature alert points:

Audible (48°C [±2] on Ranger unit display) _____°C

Secondary (50°C [±2]) _____°C

Date _____ **Operating temperature:** (Specification = 41°C±1) _____°C

Over-temperature alert points:

Audible (48°C [±2] on Ranger unit display) _____°C

Secondary (50°C [±2]) _____°C

Replacing the Power Fuse

The power fuses are located in the power entry module.

TOOLS AND EQUIPMENT

Small slotted screwdriver

METHOD

1. Disconnect the warming unit from the power source.
2. Remove the power cord.
3. Locate the fuse carrier in the power entry module.
4. Use the small screwdriver to remove the fuse carrier from the power entry module.
5. Remove the blown fuse from the fuse carrier and replace with a new fuse (as marked).
6. Place the fuse carrier back into the power entry module.
7. Reattach the power cord.
8. Reconnect the warming unit to the power source.
9. Turn the unit on to verify normal operation.
10. Record the maintenance action taken.

Troubleshooting

CONDITION	CAUSE	SOLUTION
Nothing illuminates on the warming unit panel.	<ul style="list-style-type: none"> Unit is not turned on, plugged in, or power cord is not plugged into an appropriate outlet. Unit failure. 	<ul style="list-style-type: none"> Turn unit on. Make sure the power cord is plugged into the power entry module of the warming unit. Make sure the warming unit is plugged into a properly grounded outlet. Check fuses. Call 3M technical support.

CONDITION	CAUSE	SOLUTION
Alert indicator illuminates and alert sounds, alphanumeric display alternately flashes a temperature of 43°C for the Model 245 (48°C for the Model 247) or higher and the word “HI.”	<p>Temporary over-temperature condition because:</p> <ul style="list-style-type: none"> An extreme change in flow rates occurred (e.g., from 500 mL/min to stop flow). Unit was turned on and reached set point temperature before cassette was inserted. Fluids were prewarmed to above 42°C before being run through the warming unit. 	<ul style="list-style-type: none"> Open flow to reduce temperature. Alerts will stop when the display reads 41°C. The unit is ready to use. Alerts will stop when the display reads 41°C. The unit is ready to use. Turn off unit. Discontinue infusion of fluids. Do not warm fluids before infusing them through the Ranger warming unit.

CONDITION	CAUSE	SOLUTION
Alert sounds, alphanumeric display and alert indicator light go dark.	Primary controller failure. Unit will no longer operate.	Power to heating plates will shut off if temperature rises to 44°C for the Model 245 (50°C for the Model 247). Turn unit off and unplug it. Discontinue use of unit. Discard warming set. Alert will continue to sound if you do not unplug unit. Call 3M technical support.

CONDITION	CAUSE	SOLUTION
<ul style="list-style-type: none"> Unit alerts soon after plugging it in (unit does not have to be turned on for this condition to occur). 	Over-temperature screw on bottom of unit is loose or missing.	Make sure over-temperature screw is completely tightened. If it is missing, turn unit off and unplug it. Call 3M technical support.
<ul style="list-style-type: none"> Heater temperature rises to 44°C for Model 245 (50°C for Model 247) and unit shuts down soon after plugging it in (unit does not have to be turned on for this condition to occur). 		

CONDITION	CAUSE	SOLUTION
Alert sounds but unit has been turned off.	<ul style="list-style-type: none"> Independent backup safety system has been activated. Over-temperature screw loose. 	<ul style="list-style-type: none"> Unplug unit. Call 3M technical support. Make sure over-temperature screw is completely tightened. If it is missing, turn unit off and unplug it. Call 3M technical support.

CONDITION	CAUSE	SOLUTION
Cannot remove cassette from unit.	<ul style="list-style-type: none"> Cassette is too full, fluids are still being infused, or clamp is open proximal to the cassette. Warming unit is below patient level, creating excessive back pressure. 	<ul style="list-style-type: none"> Make sure fluid is drained from cassette before sliding out the cassette, that fluids are no longer infusing, and that clamp is closed proximal to the warming cassette. Raise unit above patient level.

CONDITION	CAUSE	SOLUTION
Alert indicator light illuminates and alert sounds, alphanumeric display alternately flashes a temperature of 33°C or below and the word “LO.”	Under-temperature condition caused by very high flow using very cold fluid, or defective heater/relay.	Alert should stop when temperature rises above 33°C. If alert continues, turn off unit, unplug unit and discontinue use. Call 3M technical support.

CONDITION	CAUSE	SOLUTION
Alphanumeric display reads “Er 4” or “Open.”	Open wire on temperature sensor.	Do not use unit. Call 3M Patient Warming technical support.

CONDITION	CAUSE	SOLUTION
Alphanumeric display reads “Er 5” or “Open.”	Electrical interference.	Remove the unit. Refer to biomedical technician or call 3M technical support.

Specifications

PHYSICAL CHARACTERISTICS

WARMING UNIT

4.5 in. (11 cm) high x 7.5 in. (19 cm) wide x 10 in. (25 cm) long; wt.: 7 lb. 7 oz. (3.4 kg)

CERTIFICATIONS

IEC/EN 60601-1; CAN/CSA-C22.2, No. 601.1

CLASSIFICATION

MEDICAL — GENERAL MEDICAL EQUIPMENT AS TO ELECTRICAL SHOCK, FIRE AND MECHANICAL HAZARDS ONLY IN ACCORDANCE WITH UL 60601-1; CAN/CSA-C22.2, No. 601.1; ANSI/AAMI ES60601-1:2005 CSA-C22.2 No. 60601-1:08; Control No. 4HZ8

Classified under IEC 60601-1 Guidelines (and other national versions of the Guidelines) as Class I, Type BF, Ordinary equipment, Continuous operation. Classified by Underwriters Laboratories Inc. with respect to electric shock, fire and mechanical hazards only, in accordance with IEC/EN² 60601-1 and in accordance with Canadian/CSA C22.2, No. 601.1. Classified under the Medical Device Directive as a Class IIb device.



ELECTRICAL CHARACTERISTICS

DEVICE RATING

100-120 VAC, 50/60 Hz
220-240 VAC, 50/60 Hz

MAXIMUM HEATING POWER

900 W

FUSE

2 x T10A-H (250V) for 100-120 VAC
2 x T6.3A-H (250V) for 220-240 VAC

FUSE TYPE

Time delay, high breaking

TEMPERATURE CHARACTERISTICS

SET POINT TEMPERATURE

41°C

OVER-TEMPERATURE ALERT

Model 245:

43°C

Model 247:

48°C

UNDER-TEMPERATURE ALERT

33°C

OVER-TEMPERATURE CUTOFF

Model 245:

44°C (warming units Rev N and newer)

46°C (warming units Rev A to M)

Model 247:

50°C

LEAKAGE CURRENT

Meets leakage current requirements in accordance with UL/IEC 60601-1.

ENVIRONMENTAL CONDITIONS

OPERATING TEMPERATURE RANGE

15° to 40°C (59° to 104°F)

STORAGE TEMPERATURE RANGE

-20° to 45°C (-4° to 113°F)

OPERATING HUMIDITY

10 to 85% RH, noncondensing

ATMOSPHERIC PRESSURE RANGE

50 kPa to 106 kPa