

3M Ranger™ Blood/Fluid Warming System Model 245 Operator's Manual

- Ⓒ Blood/fluid warming system • Operator's Manual
- Ⓕ Système de réchauffement de sang/liquide • Manuel d'utilisation
- Ⓓ Blut- und Infusionswärmesystem • Benutzerhandbuch
- Ⓙ Sistema di riscaldamento di sangue/fuidi • Manuale per l'operatore
- Ⓔ Sistema de calentamiento de sangre y fluidos • Manual del operador
- Ⓝ Bloed/vloeistofverwarmingssysteem • Gebruikershandleiding
- Ⓔ Blod-/vätskeuppvärmningssystem • Användarhandbok
- Ⓓ Blod-/væskevarmesystem • Brugervejledning
- Ⓝ Oppvarmingssystem for blod/væske • Brukerveiledning
- Ⓕ Veren-/nesteenlämmitysjärjestelmä • Käyttäjän opas
- Ⓕ Sistema de Aquecimento de Sangue/Fluidos • Manual do Utilizador
- Ⓒ Σύστημα θέρμανσης αίματος/υγρών • Εγχειρίδιο Χειρισμού
- Ⓕ System do podgrzewania płynów/krwi • Instrukcja obsługi
- Ⓒ Vér-/folyadékmelegítő rendszer • Kezelői kézikönyv
- Ⓒ Ohřívací systém pro krev/tekutiny • Návod k obsluze
- Ⓕ Kraujo / skysčio šildymo sistema • Operatoriaus vadovas
- Ⓒ Система для подогрева крови/жидкости • Руководство по эксплуатации
- Ⓒ Kan/sivi ısıtma sistemi • Kullanım Kılavuzu
- Ⓒ 血液/輸液加温システム取扱説明書
- Ⓒ 输血/输液升温系统 • 操作指南
- Ⓒ دليل المستخدم • نظام تدفئة الدم/السوائل

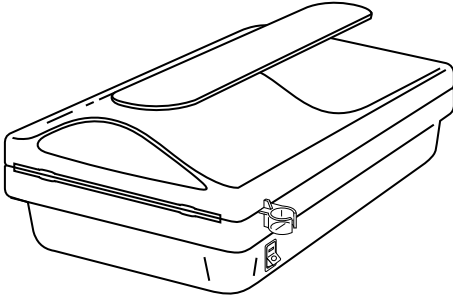

3M

Ranger™

Blood/Fluid

Warming System

Model 245

Operator's Manual

English	1
Français	17
Deutsch	35
Italiano	55
Español	73
Nederlands	91
Svenska	109
Dansk	127
Norsk	145
Suomi	163
Português	181
Ελληνικά	199
Polski	217
Magyar	235
Česky	253
Lietuviškai	271
Русский	289
Türkçe	307
日本語	325
中文	343
دليل المستخدم	361

Table of Contents

Technical Service and Order Placement	2
Introduction	3
Indications for use	3
Definition of Symbols	3
Explanation of Signal Word Consequences	4
Warning:	5
Caution:	5
Notice:	6
Product Description	6
The Ranger blood/fluid warming unit	6
Ranger blood/fluid warming set	7
Product safety features	8
Instructions for Use	10
Preparation and setup of the Ranger blood/fluid warming unit	10
Removing the warming set from the Ranger blood/fluid warming unit	11
Transferring the warming set from one Ranger warming unit to another	11
Maintenance and Storage	14
Specifications	16

Technical Service and Order Placement

USA

TEL: +1-952-947-1200
+1-800-733-7775

FAX: +1-952-947-1400
+1-800-775-0002

Outside of the USA

Contact your local 3M Patient Warming representative.

In-warranty repair and exchange

To return a device to 3M Patient Warming for service, first obtain a Return Authorization (RA) number from a customer service representative. Please use the (RA) number on all correspondence when returning a device for service. A shipping carton will be delivered to you at no charge, if needed. We will service and ship your device within five (5) working days of our receipt. Call your local supplier or sales representative to inquire about loaner devices while your device is being serviced.

When you call for technical support

Remember, we will need to know the serial number of your unit when you call us. The serial number label is located on the bottom of the warming unit.

Introduction

The 3M™ Ranger™ blood/fluid warming system includes a warming unit and a disposable warming set. The Ranger blood/fluid warming system is designed to warm blood, blood products, and liquids and deliver these at flow rates from KVO to 500 mL/min. At these flow rates, the device maintains fluid output temperatures ranging from 33°C to 41°C (Note: Output temperatures are dependant on input fluid temperatures and flow rate). It takes less than 2 minutes to warm up to the 41°C set point temperature.

Disposable blood/fluid warming sets are available in: pediatric flow, standard flow, and high flow applications. Warming sets are sterile, latex-free, single-use-only items and are designed to be used with the warming unit.

The Ranger blood/fluid warming unit is designed to be mounted to an I.V. pole. A handle located on the top of the unit makes transport easy. When mounted to the I.V. pole, the unit fits easily above the 3M™ Bair Hugger™ warming unit. For additional information on the Ranger blood/fluid warming sets visit us online at rangerfluidwarming.com.

This manual includes operating instructions and unit specifications for the Ranger blood/fluid warming system. For information about using Ranger blood/fluid warming sets with the Ranger blood/fluid warming unit, Model 245, refer to the "Instructions for Use" included with each warming set. The Ranger blood/fluid warming system should only be used in healthcare facilities by trained medical professionals.

Indications for use

The Ranger blood/fluid warming system is intended to warm blood, blood products, and liquids.

Definition of Symbols



ON



OFF



Fuse



CAUTION

















Type B Applied Part

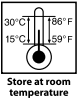

Voltage, Alternating Current (AC)

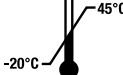

An equipotentiality plug (grounded) conductor other than a protective earth conductor or a neutral conductor, providing a direct connection between electrical equipment and the potential equalization busbar of the electrical installation. Please consult IEC 6060-1; 2005 for requirements.

	This system is subject to European WEEE Directive 2002/96/EC. This product contains electrical and electronic components and must not be disposed of using standard refuse collection. Please consult local directives for disposal of electrical and electronic equipment.
	Protective earth ground
	Consult instructions for use
	Follow instructions for use
	Recycle to avoid environmental contamination. This product contains recyclable parts. For information on recycling - please contact your nearest 3M Service Center for advice.
	Date of manufacture
	Manufacturer
	Sterile, ethylene oxide
	Store at room temperature
	DEHP-free
	Container quantity
	Single use
	Latex free
	Keep dry
	Temperature limits

Explanation of Signal Word Consequences



WARNING:

Indicates a hazardous situation which, if not avoided, could result in death or serious injury.



CAUTION:

Indicates a hazardous situation which, if not avoided, could result in minor or moderate injury.

NOTICE:

Indicates a situation which, if not avoided, could result in property damage only.

**WARNING:**

1. To reduce the risks associated with hazardous voltage and fire and thermal energy hazards:
 - Do not substitute other devices (i.e. Model 247) for the Ranger blood/fluid warming unit or Ranger blood/fluid warming sets.
 - Do not continue use of the unit if the over-temperature alert continues to sound and the temperature does not return to the set point temperature. Immediately stop fluid flow and discard the warming set. Have the blood/fluid warming unit tested by a biomedical technician or call 3M Patient Warming technical service.
2. To reduce the risks associated with hazardous voltage and fire:
 - Do not modify or service this device, and do not open the warming unit case as there are no user-serviceable parts in the unit.
 - Connect power cord to receptacles marked “Hospital Only,” “Hospital Grade,” or a reliably grounded outlet.
 - Use only the power cord specified for this product and certified for the country of use.
 - Do not allow the power cord to get wet.
 - Do not use the Ranger blood/fluid warming system when it appears the unit power cord, or warming set is damaged. Use only 3M specified replacement parts.
 - Keep power cord visible and accessible at all times. The plug on the power cord serves as the disconnect device. The wall socket outlet shall be as close as practical and shall be easily accessible.
3. To reduce the risks associated with air embolism:
 - Never infuse fluids if air bubbles are present in the fluid line.

**CAUTION:**

1. To reduce the risks associated with cross-contamination:
 - The cleaning tool provides only superficial cleaning, it does not disinfect or sterilize the interior of the unit.
2. To reduce the risks associated with impact and facility medical device damage:
 - Clamp the Ranger blood/fluid warming unit to an I.V. pole with a minimum 14” (35.6 cm) radius wheelbase and at a height no higher than 44” (112 cm).
3. To reduce the risks associated with environmental contamination:
 - Follow applicable regulations when disposing of this device or any of its electronic components.
4. Do not use for direct cardiac application. When using the Ranger blood/fluid warming system with a central venous catheter (CVC), ensure that the catheter tip does not have direct contact with the heart and ensure that all electrical devices connected to or near the patient have an appropriate leakage current rating for the application. If a CVC tip is found to be in direct contact with a patient’s heart, the blood/fluid warming unit, Model 245 should be immediately disconnected from the CVC until the CVC is safely repositioned. Failure to follow these precautions may cause cardiac disturbance and/or patient injury.

NOTICE:

1. Federal law (USA) restricts this device to sale by or on the order of a licensed healthcare professional.
2. To avoid device damage:
 - Do not clean the blood/fluid warming unit with solvents. Damage to the case, label, and internal components may result.
 - Do not immerse the blood/fluid warming unit in cleaning or sterilizing solutions. The unit is not liquid proof.
 - Do not insert metallic instruments in the blood/fluid warming unit.
 - Do not use abrasive materials or solutions to clean the heater plates.
 - Do not allow spills to dry inside the unit, as this may make it more difficult to clean the unit.
3. The Ranger blood/fluid warming unit meets medical electronic interference requirements. If radio frequency interference with other equipment should occur, connect the unit to a different power source.

Product Description

The Ranger blood/fluid warming system consists of a Model 245 warming unit and a sterile warming set.

The Ranger blood/fluid warming unit

The blood/fluid warming unit is a compact, lightweight, liquid-resistant device with a clamp located on the side for attachment to an I.V. pole. A carrying handle on the top of the unit makes it easy to transport. Located on the front panel you will find:

- Alphanumeric display that indicates the heater temperature during normal operation. In an over-temperature condition, the display alternately flashes a temperature of 43°C or higher and the word “HI.” An audible alert also sounds. In an under-temperature condition, the display alternately flashes a temperature of 33°C or lower and the word “LO.”
- Alert indicator light that comes on when either an over- or under-temperature condition occurs.

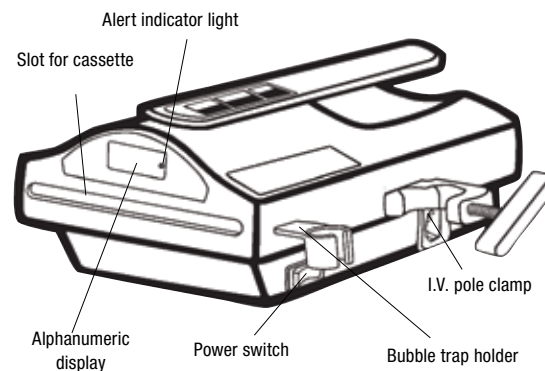

Ranger blood/fluid warming set

Blood/fluid warming sets include a cassette, tubing and connectors compatible with hospital standard I.V. blood/fluid administration sets, bubble trap, and injection port. The high flow set also includes 2 blood/fluid bag spikes and a 150 micron filter located in a central drip chamber.

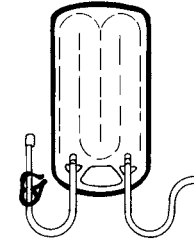

Warming Set

	FLOW RATE	PRIMING VOLUME	PATIENT LINE LENGTH
Standard Flow Set	150 mL/min	39-44 mL	76 cm 152 cm (76 cm patient line plus 76 cm extension)
High Flow Set	100-500 mL/min	150 mL	152 cm (76 cm patient line plus 76 cm extension)
Pediatric/Neonate	100 mL/min	20 mL	46 cm

Refer to the instructions provided with each warming set for information on use.

Product safety features

The following chart describes the safety alert features of the Ranger blood/fluid warming unit.

ALERT TYPE	WHAT TO LOOK FOR	DESCRIPTION/ CAUSE	ACTION
Over-temperature alert - 43°C	Alert indicator light illuminates and alert sounds, alphanumeric display alternately flashes a temperature of 43°C or higher and the word "HI."	Heater temperature rose to 43°C because of transient conditions.*	Observe alphanumeric display. If temperature does not drop to 41°C (may take a few minutes), discontinue use of unit. Call 3M Patient Warming customer service.
Under-temperature alert - 33°C	Alert indicator light illuminates and alert sounds, alphanumeric display alternately flashes a temperature of 33°C or lower and the word "LO."	Heater temperature has fallen to 33°C.	Alerts stop when temperature rises above 33°C. Continue use of unit. If the temperature does not rise above 33°C, unplug the unit and call 3M Patient Warming customer service.

*Transient conditions may cause an over-temperature alert condition. These conditions include:

- There was an extreme change in flow rates (e.g., from 500 mL/min to stop flow).
- The unit was turned on and reached the set point temperature of 41°C before the warming cassette was inserted in the device.
- Fluids were prewarmed to above 42°C before being infused.

Warming units Rev A to M

ALERT TYPE	WHAT TO LOOK FOR	DESCRIPTION/ CAUSE	ACTION
Independent back-up safety alert - 46°C	<ul style="list-style-type: none"> Alert indicator light illuminates and alert sounds, alphanumeric display alternately flashes a temperature of 43°C or higher and the word "HI." Alphanumeric display is dark, alert sounds (backup safety alert still works even if display is dark). 	Heater temperature rose to 46°C. Safety backup system is activated at 46°C and unit shuts off power to the heating plates.	TURN OFF THE UNIT AND UNPLUG IT. Do not use the unit. Discard the disposable set. Call 3M Patient Warming customer service.

Warming units Rev N and newer

ALERT TYPE	WHAT TO LOOK FOR	DESCRIPTION/ CAUSE	ACTION
Independent back-up safety alert - 44°C	<ul style="list-style-type: none"> Alert indicator light illuminates and alert sounds, alphanumeric display alternately flashes a temperature of 43°C or higher and the word "HI." Alphanumeric display is dark, alert sounds (backup safety alert still works even if display is dark). 	Heater temperature rose to 44°C. Safety backup system is activated at 44°C and unit shuts off power to the heating plates.	TURN OFF THE UNIT AND UNPLUG IT. Do not use the blood/fluid warming unit. Discard the set. Call 3M Patient Warming customer service.

Instructions for Use

Preparation and setup of the Ranger blood/fluid warming unit

1. Attach the Ranger blood/fluid warming unit to the I.V. pole.
Tighten the pole clamp securely.



CAUTION: To reduce the risks associated with impact and facility medical device damage:

- Clamp the Ranger blood/fluid warming unit to an I.V. pole with a minimum 14" (35.6 cm) radius wheelbase and at a height no higher than 44" (112 cm).
2. Slide the cassette into the slot in the warming unit. The cassette can only fit into the device one way.
 3. Prime the warming set. For more information about priming the set, refer to instructions provided with the warming sets.
 4. Place the bubble trap in the holder.
 5. Plug the power cord into an appropriate outlet. Turn the unit ON. In a few seconds the alphanumeric display will illuminate. It takes less than two minutes to warm up to the 41°C set point temperature.
 6. Begin infusion. When infusion is completed, remove the warming set and discard according to institutional protocol.

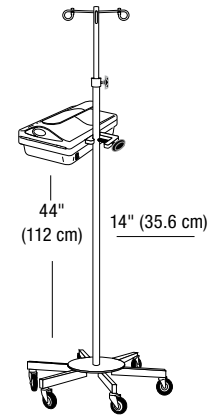

Removing the warming set from the Ranger blood/fluid warming unit

1. Close the inlet clamp proximal to the cassette and open all clamps distal to the cassette.
2. Disconnect the warming set from the fluid source, if applicable.
3. Allow fluid to flow to the patient (this may take 2-3 seconds). Close a distal clamp.
4. Remove the cassette from the warming unit and discard according to institutional protocol.
5. Reconnect the patient I.V. line to the fluid source to continue the infusion without warming.

Transferring the warming set from one Ranger warming unit to another

1. Follow steps 1-3 above, then remove the warming set from the first warming unit.
2. During transport, keep the clamps closed and do not infuse fluids while the cassette is outside of the warming unit.
3. Slide the cassette into the second warming unit.
4. Ensure that air is removed from the tubing.
5. Open the clamps and continue the infusion.

Troubleshooting

CONDITION	CAUSE	SOLUTION
Nothing illuminates on the warming unit panel.	<ul style="list-style-type: none"> Unit is not turned on, plugged in, or power cord is not plugged into an appropriate outlet. Unit failure. 	<ul style="list-style-type: none"> Turn unit on. Make sure the power cord is plugged into the power entry module of the warming unit. Make sure the warming unit is plugged into a properly grounded outlet. Call 3M Patient Warming customer service.

CONDITION	CAUSE	SOLUTION
Alert indicator illuminates and alert sounds, alphanumeric display alternately flashes a temperature of 43°C or higher and the word “HI.”	<p>Temporary over-temperature condition because:</p> <ul style="list-style-type: none"> An extreme change in flow rates occurred (e.g., from 500 mL/min to stop flow). Unit was turned on and reached set point temperature before cassette was inserted. Fluids were prewarmed to above 42°C before being run through the warming unit. 	<ul style="list-style-type: none"> Open flow to reduce temperature. Alerts will stop when the display reads 41°C. The unit is ready to use. Alerts will stop when the display reads 41°C. The unit is ready to use. Turn off unit and unplug it. Discontinue infusion of fluids. Do not warm fluids before infusing them through the Ranger warming unit.

CONDITION	CAUSE	SOLUTION
Alert sounds, alphanumeric display and alert indicator light go dark.	Primary controller failure. Unit will no longer operate.	Power to heating plates will shut off if temperature rises to 44°C (warming unit Rev N and newer) or 46°C (warming units Rev A to M). Turn unit off and unplug it. Discontinue use of unit. Discard disposable set. Alert will continue to sound if you do not unplug unit. Call 3M Patient Warming customer service.

3M™ Ranger™ Blood/Fluid Warming System

English 13

CONDITION	CAUSE	SOLUTION
<ul style="list-style-type: none"> Unit alerts soon after plugging it in (unit does not have to be turned on for this condition to occur). Heater temperature rises to 44°C (warming units Rev N and newer) or 46°C (warming units Rev A to M) and unit shuts down soon after plugging it in (unit does not have to be turned on for this condition to occur). 	Test screw on bottom of unit is loose or missing.	Make sure test screw is completely tightened. If it is missing, turn unit off and unplug it. Call 3M Patient Warming customer service.
CONDITION	CAUSE	SOLUTION
Alert sounds but unit has been turned off.	Independent backup safety system has been activated.	Unplug unit. Call 3M Patient Warming customer service.
CONDITION	CAUSE	SOLUTION
Cannot remove cassette from unit.	<ul style="list-style-type: none"> Cassette is too full, fluids are still being infused, or clamp is open proximal to the cassette. Warming unit is below patient level, creating excessive back pressure. 	<ul style="list-style-type: none"> Make sure fluid is drained from cassette before sliding out the cassette, that fluids are no longer infusing, and that clamp is closed proximal to the warming cassette. Raise unit above patient level.
CONDITION	CAUSE	SOLUTION
Alert indicator light illuminates and alert sounds, alphanumeric display alternately flashes a temperature of 33°C or below and the word “LO.”	Under temperature condition caused by very high flow using very cold fluid, or defective heater/relay.	Alert should stop when temperature rises above 33°C. If alert continues, turn unit off, unplug unit and discontinue use. Call 3M Patient Warming customer service.
CONDITION	CAUSE	SOLUTION
Alphanumeric display reads “Er 4” or “Open.”	Open wire on temperature sensor.	Do not use unit. Call 3M Patient Warming customer service.
CONDITION	CAUSE	SOLUTION
Alphanumeric display reads “Er 5” or “Open.”	Electrical interference.	Remove the unit. Refer to biomedical technician or call 3M Patient Warming customer service.

Maintenance and Storage

Cleaning the Ranger blood/fluid warming unit

Clean the Ranger warming unit on an as-needed basis.



CAUTION

1. To reduce the risks associated with cross-contamination:
 - The cleaning tool provides only superficial cleaning, it does not disinfect or sterilize the interior of the unit.

NOTICE

1. To avoid device damage:
 - Do not immerse the warming unit in cleaning or sterilizing solutions. The unit is not liquid proof.
 - Do not clean the warming unit with solvents. Damage to the case, label, and internal components may result.
 - Do not insert metallic instruments in the warming unit.
 - Do not use abrasive materials or solutions to clean the heater plates.
 - Do not allow spills to dry inside the unit, as this may make it more difficult to clean the unit.

TO CLEAN THE EXTERIOR OF THE WARMING UNIT:

1. Disconnect the Ranger warming unit from the power source.
2. Wipe the outside of the unit with warm, soapy water, nonabrasive cleaning solutions, dilute bleach, or cold sterilants. Do not use abrasive materials.
3. Wipe with a dry, soft cloth.

TO CLEAN THE HEATING PLATES:

The Ranger hardware cleaning tool is intended to clean both heating plates of the warming unit. It is not necessary to disassemble the warming unit to use the tool.

Method

1. Unplug the warming unit.
2. Unfold the cleaning tool. Wet the foam pads with a nonabrasive solution, such as Alconox™ brand detergent.
3. Insert the tool from the back of the unit and pull the tool all the way out from the front.
4. Rinse the tool with water and repeat 3 times.
5. Wipe off the unit to remove excess fluid.

TO CLEAN RESISTANT, DRIED-ON FLUIDS:

1. Spray a nonabrasive solution inside the slot of the warming unit and let sit for 15-20 minutes.
2. Clean the unit by using the cleaning tool.

Note: If the cleaning tool cannot be inserted through the slot of the warming unit because of excess dried-on fluids, send the unit to a biomedical technician.

Storage

Store all components in a cool, dry place when not in use.

Servicing

There are no user-serviceable parts in the Ranger blood/fluid warming unit. All service must be performed by 3M Patient Warming or an authorized service technician. Call 3M Patient Warming Technical Service at 800-733-7775 or 952-947-1200 for service information. Outside of the USA contact your local 3M Patient Warming representative.

Alconox is a trademark of Alconox, Inc.

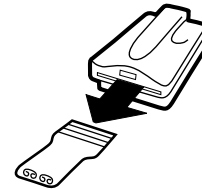
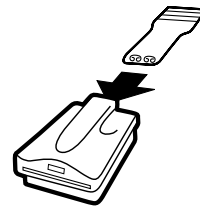

Specifications

Physical characteristics

WARMING UNIT

4.5 in. (11 cm) high x 7.5 in. (19 cm) wide x 10 in. (25 cm) long; wt.: 7 lb. 7 oz. (3.4 kg)

CERTIFICATIONS

IEC/EN 60601-1; CAN/CSA-C22.2, No.601.1

CLASSIFICATION

MEDICAL — GENERAL MEDICAL EQUIPMENT AS TO ELECTRICAL SHOCK, FIRE AND MECHANICAL HAZARDS ONLY IN ACCORDANCE WITH UL 60601-1; CAN/CSA-C22.2, No.601.1; ANSI/AAMI ES60601-1:2005 CSA-C22.2 No. 60601-1:08; Control No.4HZ8

Classified under IEC 60601-1 Guidelines (and other national versions of the Guidelines) as Class I, Type B, Ordinary equipment, Continuous operation. Classified by Underwriters Laboratories Inc. with respect to electric shock, fire and mechanical hazards only, in accordance with IEC/EN 60601-1 and in accordance with Canadian/CSA C22.2, No. 601.1. Classified under the Medical Device Directive as a Class IIb device.



Electrical characteristics

DEVICE RATING

100-120 VAC, 50/60 Hz
220-240 VAC, 50/60 Hz

MAXIMUM HEATING POWER

900 W

FUSE

2 x T10A-H (250V) for 100-120 VAC
2 x T6.3A-H (250V) for 220-240 VAC

FUSE TYPE

Time delay, high breaking

Temperature characteristics

SET POINT TEMPERATURE

41°C

OVER-TEMPERATURE ALERT

43°C

UNDER-TEMPERATURE ALERT

33°C

OVER-TEMPERATURE CUTOFF

44°C (warming units Rev N and newer)
46°C (warming units Rev A to M)

Leakage current

Meets leakage current requirements in accordance with UL/IEC 60601-1.

Environmental conditions

OPERATING TEMPERATURE RANGE

15° to 40°C (59° to 104°F)

STORAGE TEMPERATURE RANGE

-20° to 45°C (-4° to 113°F)

OPERATING HUMIDITY

10 to 85% RH, noncondensing

ATMOSPHERIC PRESSURE RANGE

50 kPa to 106 kPa



Made in the USA by 3M Health Care.

3M is a trademark of 3M Company, used under license in Canada. RANGER, BAIR HUGGER, and the BAIR HUGGER logo are trademarks of Arizant Healthcare Inc., used under license in Canada. ©2013 Arizant Healthcare Inc. All rights reserved.

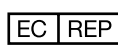
 3M Deutschland GmbH, Health Care Business
Carl-Schurz-Str. 1, 41453 Neuss, Germany

 3M Health Care, 2510 Conway Ave., St. Paul, MN 55144 USA
TEL 800-228-3957 | www.bairhugger.com
202457B 08/13