

3M™ Versaflo™ M-300 Series

Parts and Accessories

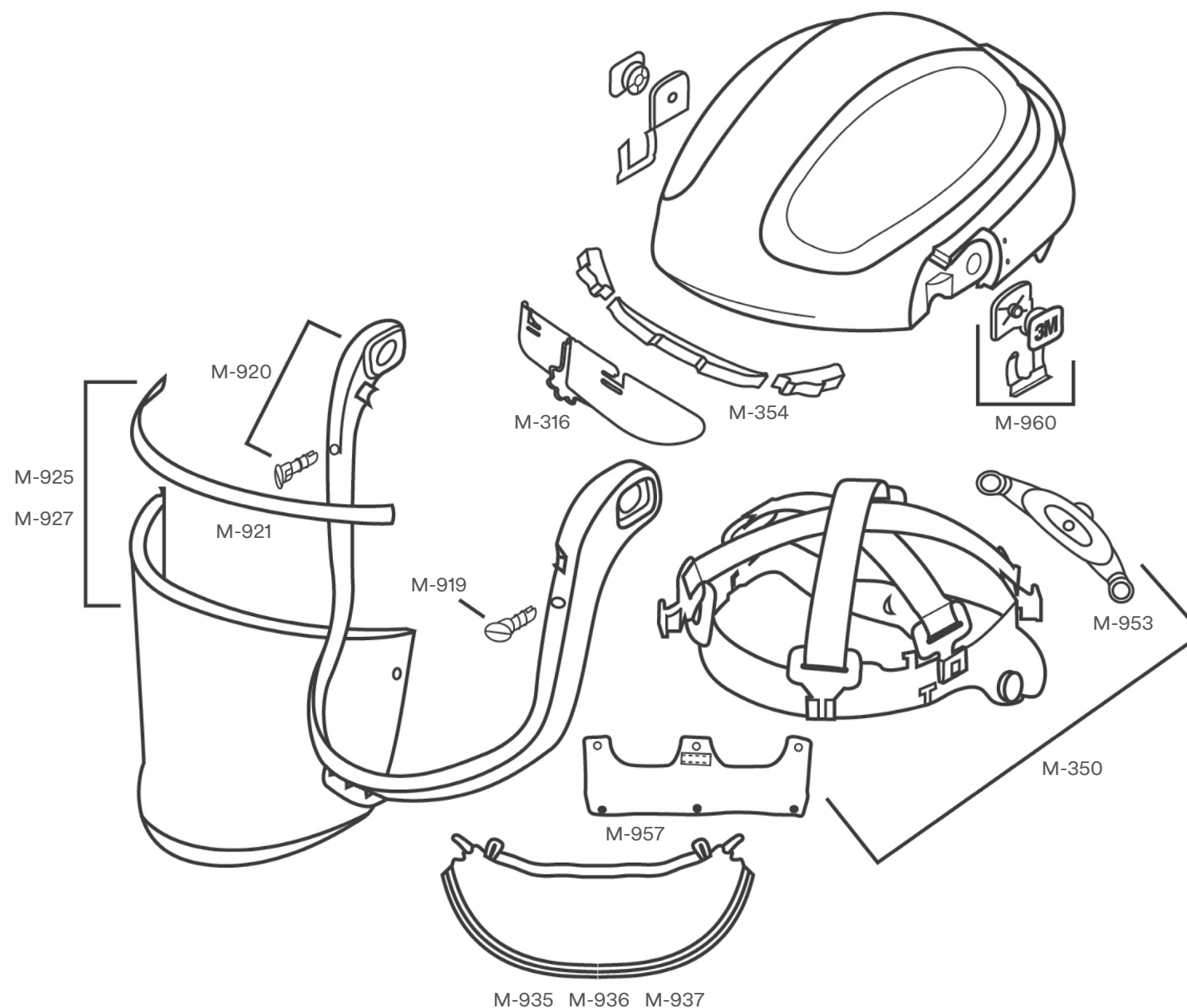

M-300 Series

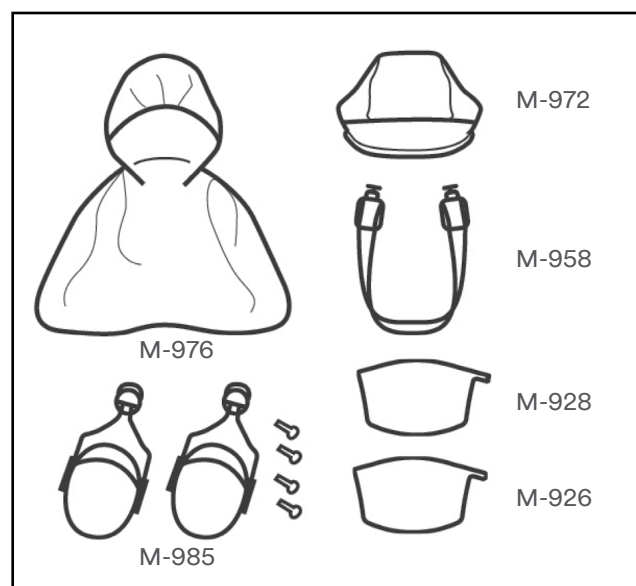

If you discover any signs of wear and/or damage, remove headgear from use and service or replace as appropriate. 3M recommends a maximum life (shelf life plus in use life) of 5 years from the date of manufacture. See the M-Series User Instructions for details on inspection and replacement.

Always read and follow all User Instructions

Part Number/ AAD	Description	Replace when maximum life is reached or when/if:	UPC Ordering #
Headgear Assemblies			
M-301	Respiratory Hardhat, without visor or face seal		0005113173156
M-305	Respiratory Hardhat Assembly: includes standard visor (M-925), face seal (M-935), size reducing comfort pad (M-956), and peel off (M-926)		0005113173163
M-307	Respiratory Hardhat Assembly: includes premium visor (M-927), flame resistant face seal (M-937), size reducing comfort pad (M-956), and peel off (M-928)		0005113173170
Replacement Parts			
M-316	Airflow Deflector	damaged or broken	0005113173187
M-350/37316	Head Suspension	damaged or broken, ratchet will not tighten, or after a severe impact	0005113173194
M-354	Forehead Seal	loose, damaged or missing	0005113173200
M-919	Visor Frame Buttons	damaged or missing	0005113173309
M-920/37320	Visor Frame Assembly: includes 2 visor frame buttons (Visor not included)	damaged or missing	0005113173204
M-921/37321	Visor Gasket	brittle, torn or otherwise damaged	0005113173211
M-925/37323	Standard Visor	scratched, cracked, crazed, warped or otherwise damaged	0005113173235
M-927/37324	Premium Visor	scratched, cracked, crazed, warped or otherwise damaged	0005113173242
M-935/37325	Standard Face Seal	torn, stretched, holes are found or otherwise damaged	0005113173259
M-936/37326	Comfort Face Seal	torn, stretched, holes are found or otherwise damaged	0005113173266
M-937	Flame Resistant Face Seal	torn, stretched, holes are found or otherwise damaged	0005113173316
M-953/37189	Headband Ratchet	damaged or broken, ratchet will not tighten	0005113173189
M-957/37010	Forehead Comfort Pad/Sweat Pad	dirty or foam begins to degrade	500511317370109
M-960	Visor Pivot Kit: includes 2 pivots, 2 springs, and 2 back plates	damaged or missing	0005113173323
Accessories			
M-926/37322	Peel-Off Visor Covers, for M-925 Standard Visor	difficult to see through	5005113173223
M-928/37452	Peel-Off Visor Covers, for M-927 Premium Visor	difficult to see through	5005113173452
M-956/37327	Size Reducing Ratchet Comfort Pad (not shown)	worn or damaged	5005113173278
M-958/37012	Chin Strap	worn or damaged	00051138662561
M-972/37331	Flame Resistant Headgear Cover	ripped, holes are found or otherwise damaged	0005113173310
M-976/37332	Head Neck and Shoulder Cover	torn, stretched, holes are found or otherwise damaged	0005113173327
M-985/37333	Headgear-Mounted Earmuff Assembly	damaged or broken	0005113173334



3M Personal Safety Division
3M Center, Building 235-2W-70
St. Paul, MN 55144-1000
3M.com

3M PSD products are occupational use only.
3M and Versaflo are trademarks of 3M Company.
Please recycle. Printed in USA © 2012, 2018 3M.
All rights reserved. 70-0716-2552-2

For More Information

In U.S.

Technical Assistance 1-800-243-4630
Hours of Operation: 8:00 a.m. – 4:30 p.m. CST
Customer Care Center 1-800-328-1667
Hours of Operation: 7:00 a.m. – 5:00 p.m. CST
Internet 3M.com/PPESafety
3M.com/Versaflo



⚠WARNING

These respirators help protect against certain airborne contaminants. Before use, the wearer must read and understand the User Instructions provided as a part of the product packaging. A written respiratory protection program must be implemented meeting all the requirements of OSHA 1910.134 including training, fit testing and medical evaluation. In Canada, CSA standards Z94.4 requirements must be met and/or requirements of the applicable jurisdiction, as appropriate. **Improper use may result in injury, sickness or death.** For correct use, see supervisor and User Instructions, or call 3M PSD Technical Service in USA at 1-800-243-4630 and in Canada at 1-800-267-4414.