

# 3M™ Betapure™ NT-T Series Filter Cartridges and Capsules

## The Next Generation in Depth Filter Technology

3M™ Betapure™ NT-T Series filter cartridges are 3M's latest advance in depth filtration technology. The all polypropylene filter is constructed using a design that utilizes flow enhancing filter media and an innovative flow pattern. The result is an absolute-rated filter with vastly superior on-stream life that provides more cost effective filtration than conventional melt-blown filter technologies. 3M Betapure NT-T Series filter cartridges — the new leader in filtration performance.

## 3M Betapure NT-T Series Filter Construction

The 3M Betapure NT-T Series cartridge was designed to provide significantly superior service life while maintaining a consistent filtration efficiency. 3M Betapure NT-T Series filters achieve this through an innovative cartridge design that allows uniform distribution of fluid flow and contaminant throughout the entire depth of the cartridge. 3M Betapure NT-T Series filter construction combines a polypropylene media with fluid distribution netting to form multiple layers. Critically positioned media flow channels allow greater movement of fluid from layer to layer. Three distinct media sections, made from multiple media/netting layers, are combined to form the filter cartridge.

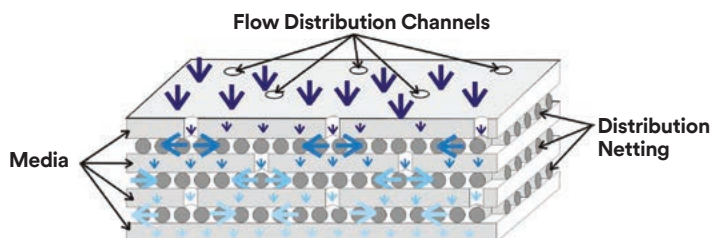

**Figure 1:** 3M™ Betapure™ NT-T Series Media Sections. Note that the actual filter sections contain multiple layers of media.

## Features & Benefits

### Superior service life

- As much as 3 times greater dirt holding capacity than competitive filters.

### All polypropylene depth filter cartridges

- Allow for broad chemical and temperature compatibility.

### Ratings from 0.5 to 70 micron

- Suit a wide range of applications.

### Absolute-rated performance

- Allows for consistent filtration quality.

### Exhibits superior particle retention under increasing differential pressure



## Applications

- **Chemical and Hydrocarbon Processing**  
Acids, bleach (sodium hypochlorite), polyethylene & polypropylene manufacture, amine sweetening and water flood
- **Food and Beverage**  
Bottled water particulate and turbidity reduction, reverse osmosis membrane and spray nozzle protection, diatomaceous earth or carbon fine trap & beverage blending, rinsing and wash water
- **Fine Chemical and Electronics**  
Pre-RO filtration of high silt density index incoming water, copper sulfate plating bath filtration in printed circuit board construction and color screen filtration for CRT production
- **Coatings**  
Film & paper coatings, photo graphic film, lens coatings & can coatings, high quality paints and ink
- **Industrial**  
Machine tool lubrication, chemicals, detergents, and waste water, textiles, plating baths, pulp and paper, process water & ground water remediation



**Cut-away of the 3M™ Betapure™ NT-T Series filter cartridge showing the three sections of media layers and core**

### 3M™ Betapure™ NT-T Series Filter Construction cont.

The outer and middle sections contain multiple layers of interleaved filter media and fluid distribution netting. Within each media layer a portion of the fluid travels through the media while the balance of the fluid is delivered directly to the next distribution layer through the flow channels. The fluid distribution netting provides longitudinal and latitudinal flow paths to evenly distribute fluid flow across the surface of each successive media layer.

### The Difference is Performance

Flow channels appear in the outer and middle sections of the filter matrix, as seen in the cartridge cut-away. The size, number, and location of the flow channels combined with the fluid distribution netting ensure that a uniform amount of contaminant is distributed to each layer within these two sections, while maintaining a consistent flow.

The number of media flow channels decrease from the outer to middle sections to ensure even contaminant loading throughout the entire filter matrix. Extensive laboratory testing has demonstrated that 3M has developed the optimal filter cartridge design.

The inner section, supported by a rigid polypropylene core and equal to approximately one third of the filter's depth, contains no flow channels and is the final qualifying section ensuring absolute rated performance.

The even distribution of contaminated fluid throughout the depth of the cartridge is the key to the 3M Betapure NT-T Series filter's exceptionally long service life, low pressure drops, and increased cost effectiveness.

### The Result

#### *Superior Filter Service Life*

Extensive testing has demonstrated that competitive filters of equivalent removal ratings subjected to the same contaminant load plug more quickly than 3M Betapure NT-T Series filters. The result is significantly shorter service life, and unpredictable filtration efficiencies. 3M Betapure NT-T Series filters provide a service life improvement of up to 3 times greater than competitive products. (Graph 1)

#### *Lower Pressure Drop*

The design and construction of the Betapure NT-T Series cartridge allows for significantly lower pressure drops compared to equivalently rated polypropylene depth filters. Based on published data, a 3M Betapure NT-T Series filter system with a given flow would use up to 75% fewer cartridges than Osmonics Selex, 68% fewer than Pall® Profile, and 42% fewer than Pall® Nexis. To underscore the 3M Betapure NT-T Series filter cost benefit, use the example in Table 1 as a guideline.

**Graph 1: 3M™ Betapure™ NT-T Series Filters deliver longer service life**

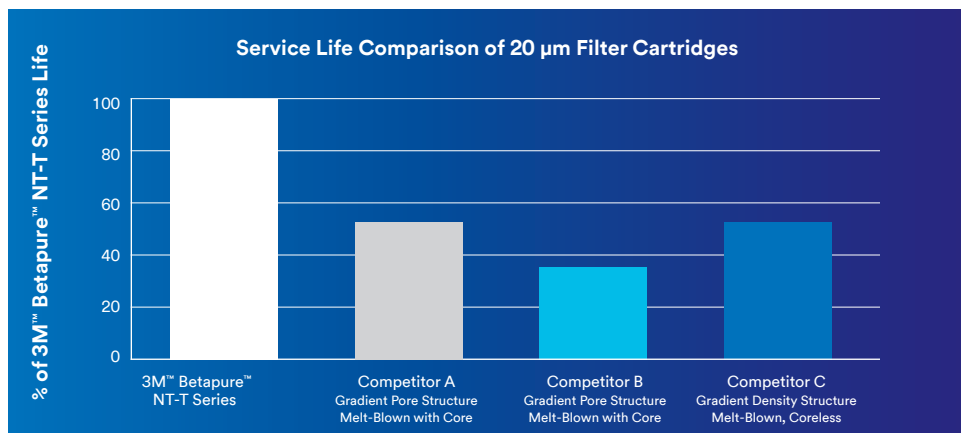

Table 1: Comparison of 5 Micron\* Filters in a 110 GPM System

|   | 3M™ Betapure™ NT-T Series Filter | Pall Profile        | Pall Nexis          | Osmonics Selex      |
|---|----------------------------------|---------------------|---------------------|---------------------|
| Flow (gpm) / 10" cartridge @ 1 psid       | 3.1                              | 1.0                 | 1.8                 | 0.8                 |
| Number of filters for a 110 gpm flow rate | 12 / 30" cartridges              | 37 / 30" cartridges | 21 / 30" cartridges | 43 / 30" cartridges |

\* Based on the manufacturers published rating.

For the same initial cartridge differential pressure, a 110 gpm system using 3M™ Betapure NT-T™ Series filters require significantly fewer cartridges. This results in lower capital investment for the filter housing and fewer cartridges to purchase.

**The Confidence of Consistency**

3M Betapure™ NT-T Series filters utilize advanced design and construction to achieve a level of filtration consistency unattainable by competitive filters. Combined with an exceptionally long service life, the 3M Betapure NT-T Series filter’s consistent performance, as illustrated by comparative Beta-Ratio vs. Differential Pressure (Graph 2), provides predictable results throughout the filters’ usable life. Filters A, B, and C show a degradation in the Beta-Ratio as psid increases. These filters exhibit a pattern of either unloading previously held particles or a loss of filtration efficiency. The result of this inconsistent performance is a reduction in finished product quality, product yield, and an increase in total filtration cost.

**Absolute Rated Betapure NT-T Series**

Consistent filtration performance, time after time, from start to finish is the goal of every filter user. Absolute removal ratings for 3M Betapure NT-T Series filters are determined using a filter performance test developed by 3M to comply with the general procedures outlines in ASTM STP 975. 3M defines absolute rating as the particle size (x) providing an initial Beta Ratio ( $B_{x_i}$ ) = 1000. At this Beta Ratio, the removal efficiency is equal to 99.9%. 3M Betapure NT-T Series filter ratings are specified in Table 2.

**Your Benefit — Total Filtration Cost Reduction**

The 3M Betapure NT-T Series filter’s performance and superior life advantage allows direct cost savings by reducing the number of filters used. In addition, the resulting reduction in filter change-out frequency decreases direct labor and filter disposal costs. 3M Betapure NT-T Series filter cartridges — providing performance and value.

Table 2: 3M™ Betapure™ NT-T Series Filter Ratings

| Grade Designation | Absolute Rating (µm) |
|-------------------|----------------------|
| T005              | 0.5 (extrapolated)   |
| T010              | 1                    |
| T020              | 2                    |
| T030              | 3                    |
| T050              | 5                    |
| T100              | 10                   |
| T200              | 20                   |
| T300              | 30                   |
| T400              | 40                   |
| T500              | 50                   |
| T700              | 70                   |

Graph 2: Beta Ratios demonstrate the Betapure™ NT-T Series filter’s ability to perform consistently throughout its life

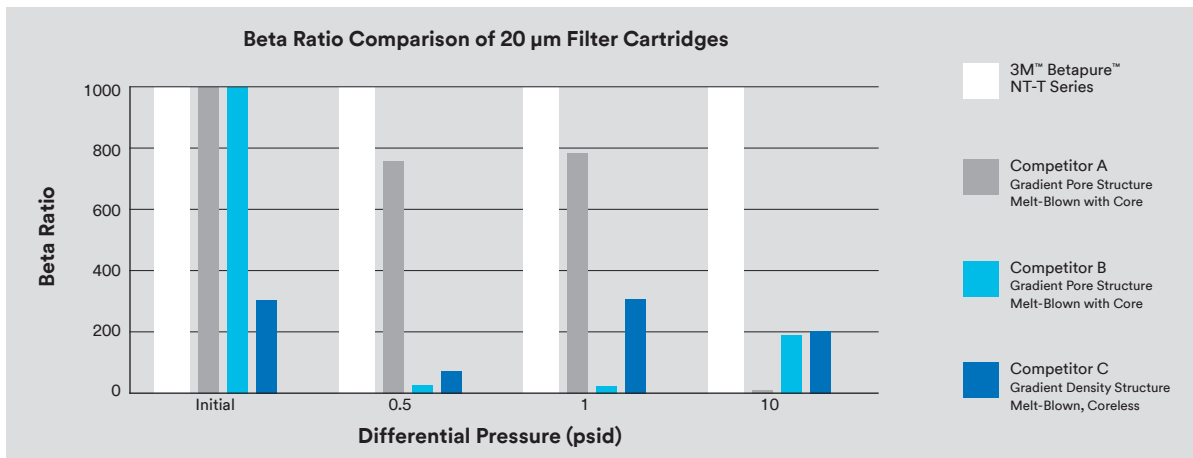



### 3M™ Betapure™ NT-T Series Filter Applications

3M Betapure NT-T Series' construction provides benefits to customers in a wide range of end-use filtration applications. High quality filtration along with total filtration cost reductions are very attractive benefits to customers in diverse industries.

#### Chemical and Hydrocarbon Processing

Cost reduction is the most critical issue in the production of high quality chemicals, petrochemicals, and in hydrocarbon processing. Using 3M Betapure NT-T Series filters in demanding applications that require absolute-rated performance provides long service life, the consistency demanded to attain quality standards, and a total Filtration Cost reduction. Applications include:

- Acids, bleach (sodium hypochlorite)
- Polyethylene and polypropylene manufacture
- Amine sweetening and waterflood

#### Food & Beverage Applications

Increased consumer emphasis on product quality, as well as increased government regulation, are driving today's food & beverage industry to ever-finer levels of filtration. 3M Betapure NT-T Series filter cartridges meet this challenge throughout their entire service life. Typical applications include:

- Bottled water particulate and turbidity reduction
- Reverse osmosis membrane and spray nozzle protection
- Diatomaceous earth or carbon fine trap
- Beverage blending, rinsing and wash water

3M™ Betapure™ NT-T series filter cartridges (but not capsules) are intended for food and beverage use and are compliant with FDA 21 CFR 174.5 and the requirements of Regulation (EC) 1935/2004 . Consult 3M for detailed declaration of compliance.

#### Fine Chemical and Electronics

3M Betapure NT-T Series filters with their filter matrix are ideally suited for electronics applications where heavy contaminant loading is present and efficient long lasting filtration is required. The combination of all-polypropylene construction and the media provide the perfect filtration device for use in wafer manufacturing and semiconductor device fabrication. Applications include:

- Pre-RO filtration of high silt density index incoming water
- Copper sulfate plating bath filtration in printed circuit board construction
- Color screen filtration for CRT production

#### Coatings

3M Betapure NT-T Series filter cartridges are well suited for the filtration of high solid coatings where they provide superior life while selectively removing the large undesired particles from the coating and allowing the smaller desired particles to pass. 3M Betapure NT-T Series applications include:

- Film & paper coatings
- Photographic film
- Lens coatings
- Can coatings, high quality paints & ink

#### Industrial

3M Betapure NT-T Series filter cartridges are ideal for higher dirt loads because of the flow characteristics and long service life that provide reduced overall filtration costs. 3M Betapure NT-T Series cartridges are used in a broad range of general industrial applications that include:

- Machine tool lubrication, chemicals, detergents, and waste water
- Textiles, plating baths
- Pulp & paper
- Process water & ground water remediation



## Flow Rates

Detailed information for calculating flows for water and fluids with other viscosities is located in the following table. Use the formula in conjunction with the values from columns 3 or 4 in table 4. The specific pressure drop values may be effectively used when three of the four variables (viscosity, flow, differential pressure, and cartridge grade) are set.

**Table 4:** 3M™ Betapure™ NT-T Series Filter Flow Rates

| Grade | Absolute Rating (µm) | Specific Pressure Drop per 10" Cartridge |              |
|-------|----------------------|--|--------------|
|       |                      | psid/gpm/cps                             | mbar/lpm/cps |
| T005  | 0.5                  | 4.5                                      | 81.9         |
| T010  | 1                    | 2.5                                      | 45.5         |
| T020  | 2                    | 0.87                                     | 15.9         |
| T030  | 3                    | 0.44                                     | 8.0          |
| T050  | 5                    | 0.32                                     | 5.9          |
| T100  | 10                   | 0.14                                     | 2.5          |
| T200  | 20                   | 0.065                                    | 1.2          |
| T300  | 30                   | 0.05                                     | 0.91         |
| T400  | 40                   | 0.042                                    | 0.76         |
| T500  | 50                   | 0.029                                    | 0.52         |
| T700  | 70                   | 0.025                                    | 0.45         |



\* Specific aqueous pressure drop at ambient temperature for a single length equivalent (10") cartridge. For multiple cartridge lengths, divide the total flow by the number of equivalent lengths. For liquids other than water, multiply the specific pressure drop value provided in the table by the viscosity in centipoise.

$$\text{Clean } \Delta p \text{ (psi (mbar))} = \frac{(\text{Total System gpm [lpm]}) (\text{Viscosity in Cp}) (\text{Value From Table})}{(\text{Number of Equivalent Single Length Cartridges in Housing})}$$

## 3M™ Betapure™ NT-T Series Filter Cartridges and Capsules

3M™ Betapure™ NT-T series filters are also available in convenient, easy to use filter capsules. The capsule design is ideal for small scale applications and bench-top evaluation.

| Nominal Capsule Dimensions |                 |                                |    |
|----------------------------|-----------------|--------------------------------|----|
|                            | Nominal Length* | With End Connections* (inches) |    |
|                            |                 | A                              | B  |
| Length (L)                 | 01              | 5                              | 5½ |
|                            | 02              | 7½                             | 8  |
| Diameter (D)               | 01              | 3                              |    |
|                            | 02              |                                |    |
| Width to Vent (W)          | 01              | 2¾                             |    |
|                            | 02              |                                |    |

\*See Ordering Guide

Note: Capsules cannot be steam sterilized.

### Capsule Flow Rates

The following are typical water flow rates for Betapure NT-P Series capsules with 1 1/2" sanitary flange connections. Other end connections will affect maximum flow rates, see the following table. Consult factory representative for flow rates for other end connections.

**Table 5:** 3M™ Betapure™ NT-T Series Capsules – Maximum Recommended Flow by End Fitting

| End Fitting          | Maximum Recommended Flow Rate (gpm) | Housing Pressure Loss (psid) |
|----------------------|-------------------------------------|------------------------------|
| 1 ½" Sanitary Flange | 6.00                                | 1.00                         |
| ¼" MNPT              | 1.50                                | 2.40                         |

## 3M™ Betapure™ NT-T Series Capsule Ordering Guide

| Cartridge Type                       | Grade Code Rating | Configuration | Nominal Length      | End Connection   | Vent O-Ring Option      | Packaging Option    |
|--------------------------------------|-------------------|---------------|---------------------|--|-------------------------|---------------------|
| NT –<br>3M™ Betapure™<br>NT-T Series | T005 0.5          | C – Capsule   | 01 – 2½"<br>02 – 5" | A – 1½"<br>Sanitary<br>Flange<br><br>B – ½" (14 mm)<br>Hose Barb | A – Silicone<br>C – EPR | 01 – Single<br>Pack |
|                                      | T010 1            |               |                     |  |                         |                     |
|                                      | T020 2            |               |                     |  |                         |                     |
|                                      | T030 3            |               |                     |  |                         |                     |
|                                      | T050 5            |               |                     |  |                         |                     |
|                                      | T100 10           |               |                     |  |                         |                     |
|                                      | T200 20           |               |                     |  |                         |                     |
|                                      | T300 30           |               |                     |  |                         |                     |
|                                      | T400 40           |               |                     |  |                         |                     |
|                                      | T500 50           |               |                     |  |                         |                     |
| T700 70                              |                   |               |                     |  |                         |                     |

**PLEASE NOTE:** The Ordering Guide above is for reference only. Not all combinations are available. Please consult with your 3M Representative to determine the appropriate part number for your application.

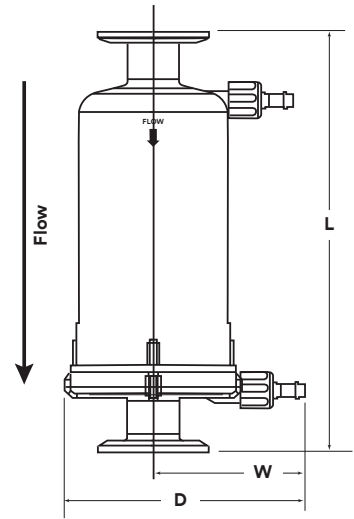

**Graph 3:** Flow Rates for 2½" capsules with 1½" Sanitary Flanges @ 20°C

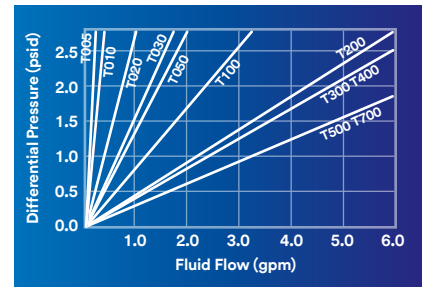

**Graph 4:** Flow Rates for 5" capsules with 1½" Sanitary Flanges @ 20°C

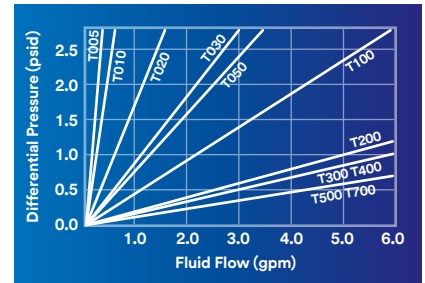

## 3M™ Betapure™ NT-T Series Ordering Guide

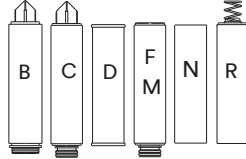
| Cartridge Grade                      | Length (Inches)          | Grade Code/ Rating (µm) | Packaging Option | Support Ring Option   | End-modification   | Gasket/O-ring Material   |
|--------------------------------------|--------------------------|-------------------------|------------------|---|--|--|
| NT –<br>3M™ Betapure™<br>NT-T Series | 06 <sup>1</sup> – 5      | T005 0.5                | S – Standard     | <b>For End Modification</b><br>D, N, R<br>0 – None<br><br><b>For End Modification</b><br>B, C, F, M<br>1 – Polysulfone<br>2 – Stainless Steel<br>0 – None | B – 226 O-Ring with Spear<br>C – 222 O-Ring with Spear<br>D – DOE with Polypropylene End Caps<br>F – 222 O-Ring with Flat Cap<br>M <sup>3</sup> – 222 O-Ring with Flat Cap<br>N – Unmodified DOE<br>R – SOE, End Cap with Spring<br><br> | <b>For End Modification</b><br>B, C, D, F, M, R<br>A – Silicone<br>B – Fluorocarbon<br>C <sup>4</sup> – EPR<br>D <sup>4</sup> – Nitrile<br>K – PTFE Encapsulated Fluorocarbon<br><br><b>For End Modification</b><br>N, R<br>G – Polyethylene |
|                                      | 09 – 9-3/4               | T010 1                  |                  |   |  |  |
|                                      | 10 – 10                  | T020 2                  |                  |   |  |  |
|                                      | 19 – 19-1/2              | T030 3                  |                  |   |  |  |
|                                      | 20 – 20                  | T050 5                  |                  |   |  |  |
|                                      | 29 <sup>2</sup> – 29-1/4 | T100 10                 |                  |   |  |  |
|                                      | 30 – 30                  | T200 20                 |                  |   |  |  |
|                                      | 39 <sup>2</sup> – 39     | T300 30                 |                  |   |  |  |
|                                      | 40 – 40                  | T400 40                 |                  |   |  |  |
|                                      |                          | T500 50                 |                  |   |  |  |
|                                      | T700 70                  |                         |                  |   |  |  |

<sup>1</sup> Requires N end modification for use in CT101 (PN 44860) only.  
<sup>2</sup> Applies to D and N end modifications only.  
<sup>3</sup> For use with 1ZMP housing.  
<sup>4</sup> O-rings C (EPR) and D (Nitrile) are excluded for use in milk and edible oils in food contact applications.



This 3M™ Betapure™ NT-T Series Filter is tested and certified by WQA against NSF/ANSI/CAN 61 for material requirements only.\*

\*For O-Ring “K” please consult factory.

**PLEASE NOTE: The Ordering Guide above is for reference only. Not all combinations are available. Please consult with your 3M Representative to determine the appropriate part number for your application.**

**Cold Water Only:**

Install this product in accordance with the instructions provided by the housing manufacturer.  
 This product has a minimum flow rate requirement of 6.6 gallons per day (25L per day).

**NOTE:** Configuration R and Gaskets/O-rings K are not listed with WQA.



### Intended Uses

The 3M Betapure™ NT-T Series Filters are intended for use in standard industrial filtration applications of aqueous fluids in accordance with the applicable product instructions and specifications.

3M Betapure™ NT-T Series Filter products are also intended for use with non-aqueous fluids where materials of construction are compatible.

Certain limited 3M Betapure™ NT-T Series Filter products are also intended for use in Food and Beverage (F&B) applications. Refer to the specific 3M Betapure™ NT-T Series Filter product's data sheet to determine whether it includes a F&B designation and can be used for such applications.

Since there are many factors that can affect a product's use, the customer and user remains responsible for determining whether the 3M product is suitable and appropriate for the user's specific application, including user conducting an appropriate risk assessment and evaluating the 3M product in user's application.

### Restrictions on Use

3M advises against the use of these 3M products in any application other than the stated intended use(s), since other applications have not been evaluated by 3M and may result in an unsafe or unintended condition. Do not use in a medical device, drug, or cosmetic application or in applications involving life-sustaining medical applications or prolonged contact with internal bodily fluids or tissues. If you are considering using this 3M product for a restricted use, you must first contact 3M with information about your proposed application to request prior written authorization for supply for such use.

### Technical Information

The technical information, guidance, and other statements contained in this document or otherwise provided by 3M are based upon records, tests, or experience that 3M believes to be reliable, but the accuracy, completeness, and representative nature of such information is not guaranteed. Such information is intended for people with knowledge and technical skills sufficient to assess and apply their own informed judgment to the information. No license under any 3M or third party intellectual property rights is granted or implied with this information.

### Product Selection and Use

Many factors beyond 3M's control and uniquely within user's knowledge and control can affect the use and performance of a 3M product in a particular application. As a result, customer is solely responsible for evaluating the product and determining whether it is appropriate and suitable for customer's application, including conducting a workplace hazard assessment and reviewing all applicable regulations and standards (e.g., OSHA, ANSI, etc.). Failure to properly evaluate, select, and use a 3M product and appropriate safety products, or to meet all applicable safety regulations, may result in injury, sickness, death, and/or harm to property.

### Warranty, Limited Remedy, and Disclaimer

Unless a different warranty is specifically stated on the applicable 3M product packaging or product literature (in which case such warranty governs), 3M warrants that each 3M product meets the applicable 3M product specification at the time 3M ships the product. 3M MAKES NO OTHER WARRANTIES OR CONDITIONS, EXPRESS OR IMPLIED, INCLUDING, BUT NOT LIMITED TO, ANY IMPLIED WARRANTY OR CONDITION OF MERCHANTABILITY, FITNESS FOR A PARTICULAR PURPOSE, OR ARISING OUT OF A COURSE OF DEALING, CUSTOM, OR USAGE OF TRADE. If a 3M product does not conform to this warranty, then the sole and exclusive remedy is, at 3M's option, replacement of the 3M product or refund of the purchase price.

### Limitation of Liability

Except for the limited remedy stated above, and except to the extent prohibited by law, 3M will not be liable for any loss or damage arising from or related to the 3M product, whether direct, indirect, special, incidental, or consequential (including, but not limited to, lost profits or business opportunity), regardless of the legal or equitable theory asserted, including, but not limited to, warranty, contract, negligence, or strict liability.

Your local distributor:



**3M Purification, Inc.**  
**3M Separation and Purification Sciences Division**  
400 Research Parkway  
Meriden, CT 06450 USA  
Phone 1-800-243-6894  
1-203-237-5541  
Web [www.3M.com/purification](http://www.3M.com/purification)

3M and Betapure are trademarks of 3M Company.  
All other trademarks are the property of their respective owners.  
© 2021 3M Company. All rights reserved.  
70020187202 REV 0221