

3M™ Cold Shrink QT-III Silicone Rubber Skirted Termination Kit

With High-K Stress Relief

For Tape Shielded, Wire Shielded and UniShield® Cable

7620-S-2

Instructions

IEEE Std. No. 48

Class 1 Termination

5/8 kV Class

95 kV BIL

CAUTION

Working around energized systems may cause serious injury or death. Installation should be performed by personnel familiar with good safety practice in handling electrical equipment. De-energize and ground all electrical systems before installing product.

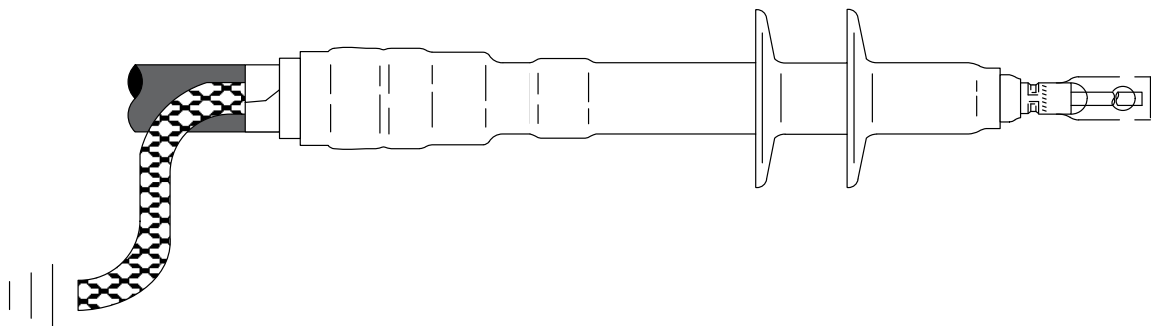

1.0 Kit Contents

- 3 High-K, Tracking Resistant, Silicone Rubber Terminations
- 3 Preformed Ground Braids
- 3 Constant Force Springs
- 3 3M™ EMI Copper Foil Shielding Tape 1181 Strips, 1/2" x 10"
- 6 Strips Scotch® Mastic Strip 2230 (black with white release liners, bagged)
- 1 3M™ Cable Cleaning Preparation Kit CC-2
- 1 Instruction Sheet

NOTE: Do Not use knives to open plastic bags.

Kit Selection Table

NOTE: Final Determination Factor is cable insulation diameter.

Kit Number	Primary Insulation O.D. Range	Jacket O.D. Range	Conductor Size Range (AWG)	
			5 kV 100% 133%	8 kV 100% 133%
7620-S-2	0.32" – 0.59" (8,1 – 15,0 mm)	0.52" – 0.78" (13,3 – 19,9 mm)	8 – 4	8 – 6

Table 1

Instructions For Tape Shielded Cable

2.0 Prepare Cable

- 2.1 Check to be sure cable size fits within kit range as shown in *Table 1*.
- 2.2 Prepare cable using dimensions shown in *Figure 1*. **BE SURE TO ALLOW FOR DEPTH OF TERMINAL LUG.** If necessary to prevent tape shield from unrolling, hold down edge with a single wrap of 3M™ EMI Copper Foil Shielding Tape 1181.

NOTE: Provide additional 1/4" (6 mm) exposed conductor distance to account for growth during crimping of ALUMINUM lugs or connectors.

NOTE: It is imperative to remove all remnants of the semi-con layer, even if the semi-con layer comes off as one layer. There should not be any remaining black areas, or particles, on the cable insulation layer.

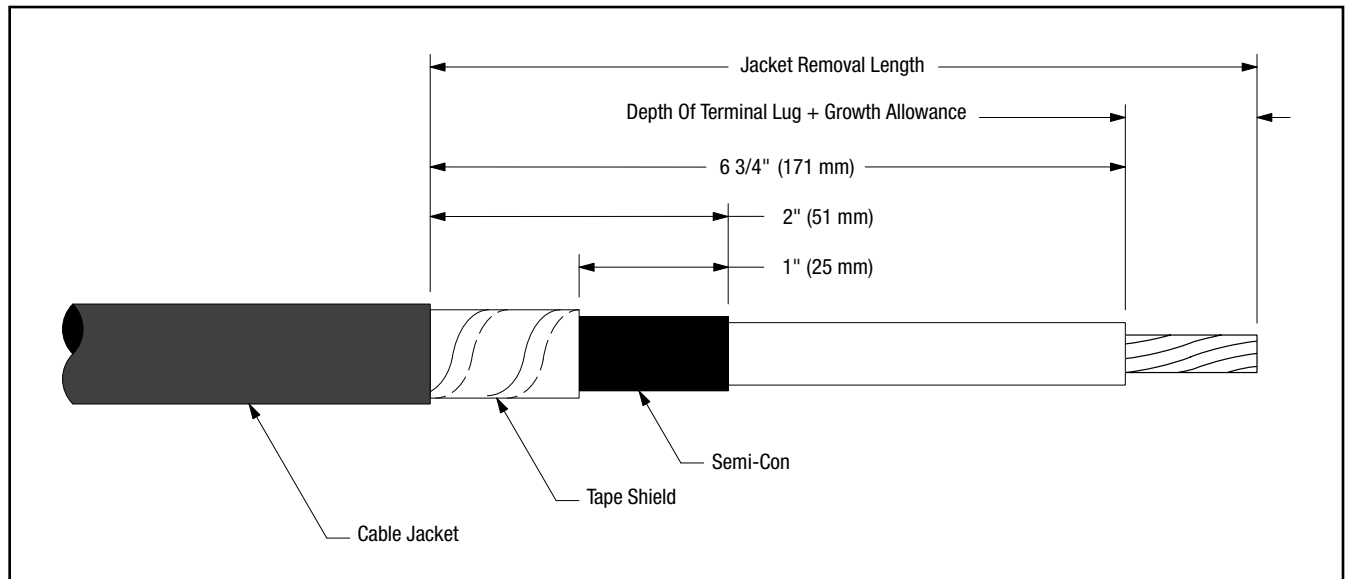

Figure 1

3.0 Install Ground Braid

- 3.1 Select a Scotch® Mastic Strip 2230 from kit and remove white release liners. Using light tension, apply a **SINGLE WRAP** of mastic around the cable jacket 1/4" (6 mm) from cut edge (*Figure 2*). Cut off excess.

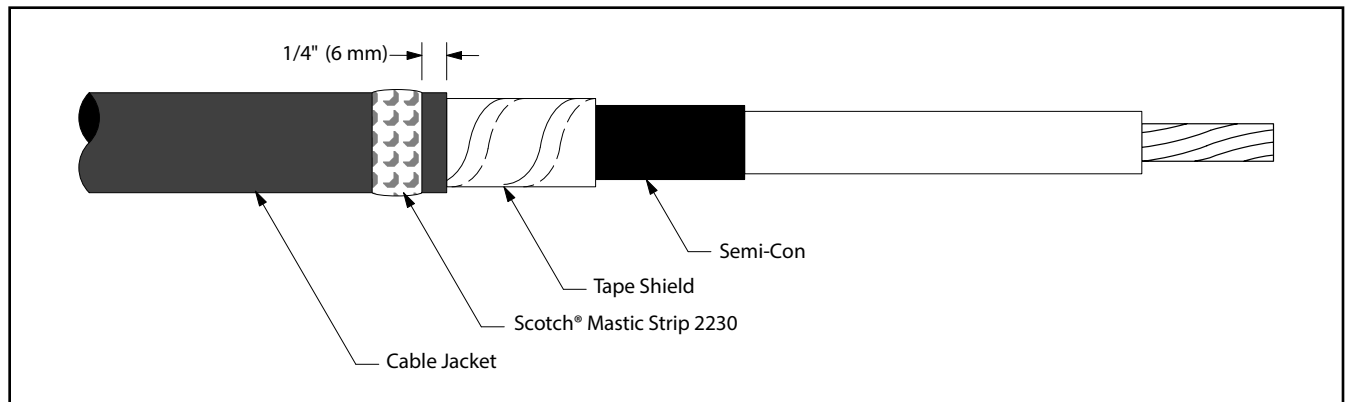

Figure 2

- 3.2 Position pre-formed ground braid with short tail over tape shield directly adjacent to cable jacket cut edge.
PLEASE NOTE: The ground braid needs to make full contact with the metallic tape shield. Position long tail of ground braid, extending over cable jacket with solder block over mastic strip (*Figure 3*). Secure ground braid to cable jacket 3 1/2" (89 mm) from cable semi-con edge using vinyl tape (*Figure 3*).

NOTE: Position vinyl tape with care, it also serves as a marker for positioning the termination.

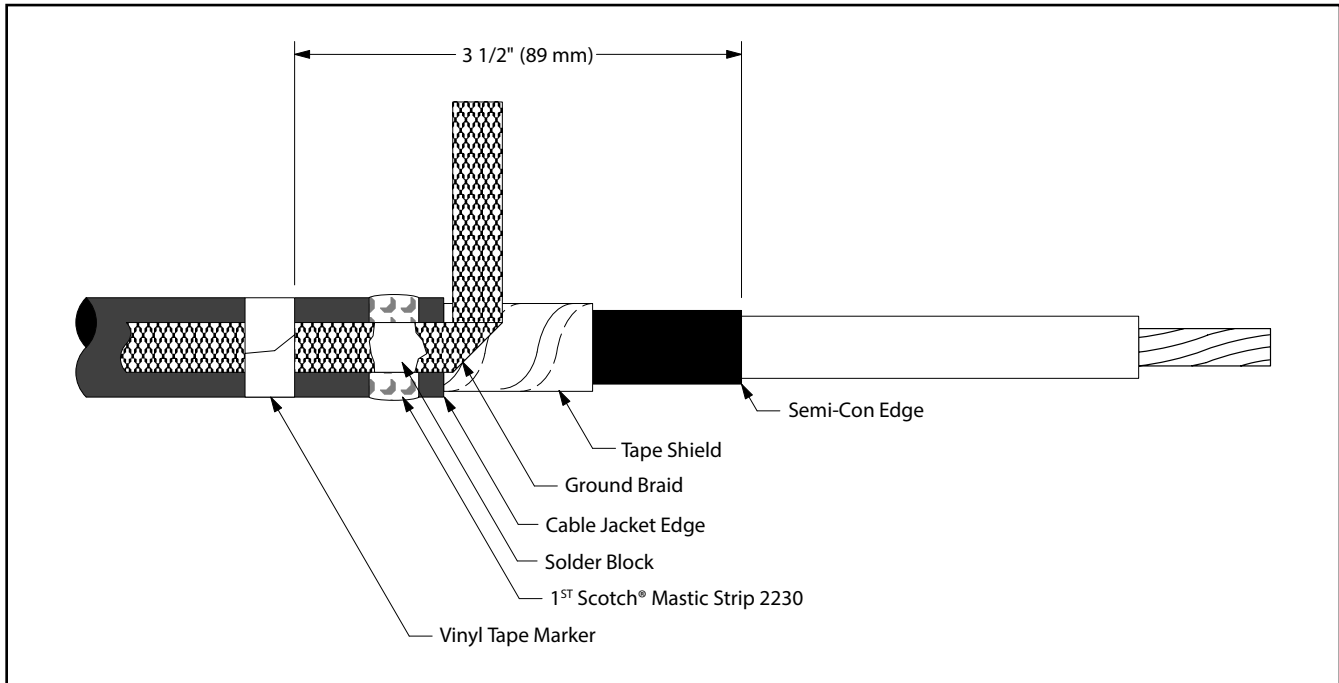

Figure 3

- 3.3 Wrap ground braid around cable tape shield one complete wrap, trim excess to prevent overlap and secure in place with constant force spring. Wrap spring in same direction as ground braid (*Figure 4*). Cinch (tighten) the spring after wrapping the final winding.
- 3.4 Select second Scotch® Mastic Strip 2230 from kit and remove white release liners. Apply a second **SINGLE WRAP** of mastic over solder block on ground braid and previously applied mastic (*Figure 4*). Cut off excess.

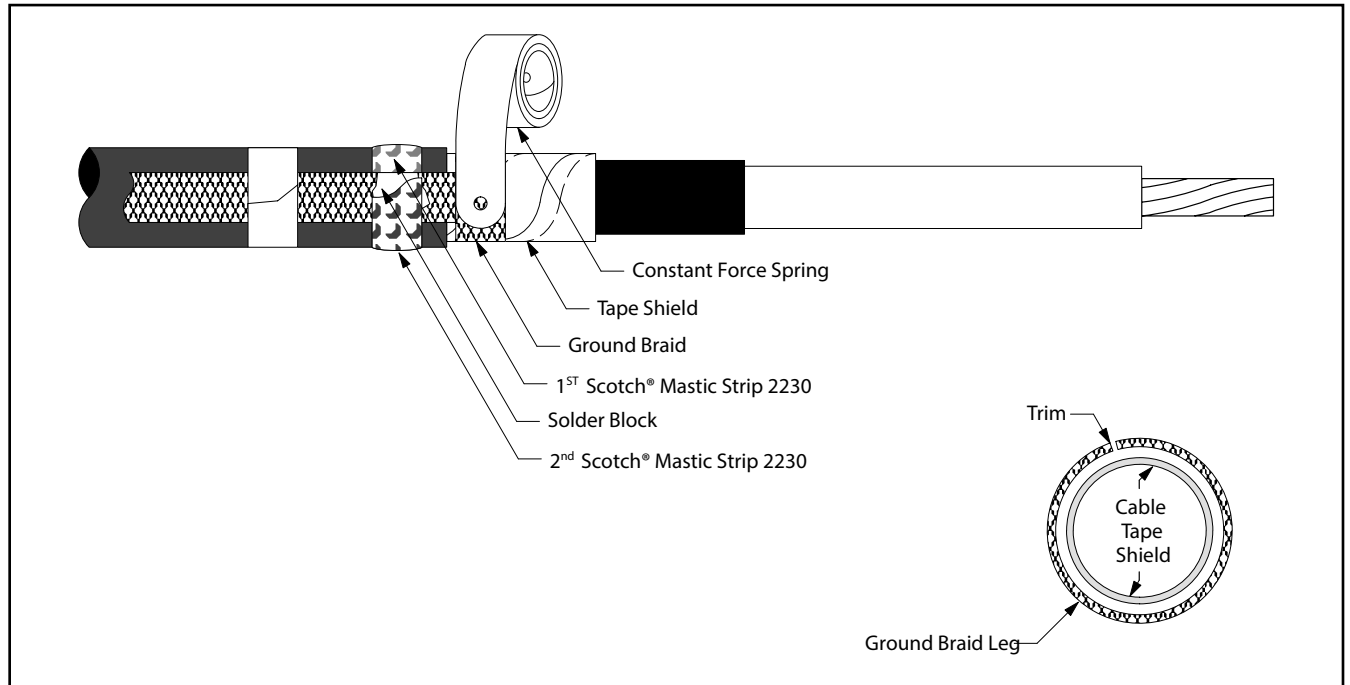

Figure 4

- 3.5 Wrap two highly stretched half-lapped layers of electrical grade vinyl tape around mastic seal, constant force spring and exposed tape shield (*Figure 5*).

NOTE: Take care not to cover exposed semi-con insulation shield. A minimum of 3/4" (19 mm) must be exposed.

SPECIAL NOTE FOR CLOTH OR PAPER SEMI-CON INSULATION SHIELD

In cables with cloth or paper semi-conductive shields it is recommended the shield be over wrapped with one half-lapped layer of highly stretched semi-conductive rubber tape such as Scotch® Electrical Semi-Conducting Tape 13.

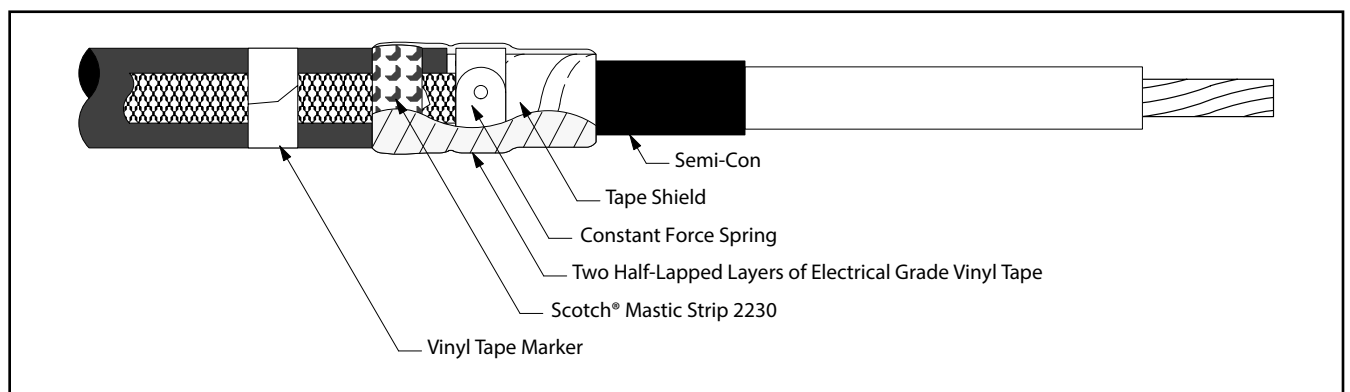

Figure 5

4.0 Install Lug or Connector

- 4.1 Check to insure 3M™ Cold Shrink QT-III Silicone Rubber Termination assembly fits over the selected lug or connector. If lug or connector (*Figure 6*) will not fit through the termination core, clean the insulation (*per Step 5.0*) and slide termination on cable before installing lug or connector. **DO NOT REMOVE CORE AT THIS TIME.**

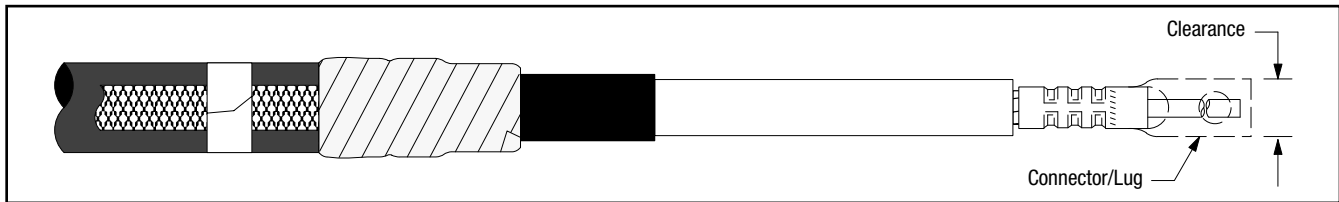

Figure 6

NOTE: Refer to pages 18 – 20 for 3M Connector and Lug crimping information.

NOTE: For Aluminum Conductors - Thoroughly wire brush conductor strands to remove aluminum oxide layer. Immediately insert conductor into lug or connector barrel as far as it will go.

- 4.2 Position connector or lug and crimp according to manufacturer's directions. Remove excess oxide inhibitor and sharp crimp flashings following crimping.

5.0 Clean Cable Insulation and Lug or Connector Barrel Using Standard Practice

- 5.1 Wipe the cable insulation with one of the solvent saturated pads from the 3M™ Cable Cleaning Preparation Kit CC-2. **DO NOT ALLOW SOLVENT TO TOUCH SEMI-CON INSULATION SHIELD!**
- 5.2 If abrasive must be used:
- Use on insulation only. **DO NOT USE ABRASIVE ON SEMI-CON INSULATION SHIELD!**
 - Use only aluminum oxide abrasive; grit 120 or finer, included in the 3M™ Cable Cleaning Preparation Kit CC-2.
 - Be careful not to reduce the cable insulation diameter below that allowed by the kit.

6.0 Install Termination

Important Packaging Notice

In order to make sure that you receive an undamaged termination, this 3M™ Cold Shrink QT-III Termination is packed with a RED SHIPPING CORE inside of the white core. Please remove the red shipping core BEFORE you install the termination. This shipping core can be recycled with other polypropylene waste.

- 6.1 Slide the termination body onto the cable and remove core. Pull while unwinding, counter-clockwise, starting with the loose end (*Figure 7*). Make sure the termination body (not the core) is butted up to the edge of the vinyl tape marker previously applied (*Figure 7*).

NOTE: Once the termination body makes contact over the mastic seal area, there is no need to continue supporting the assembly. **DO NOT PUSH OR PULL ON THE TERMINATION ASSEMBLY WHILE UNWINDING THE CORE.**

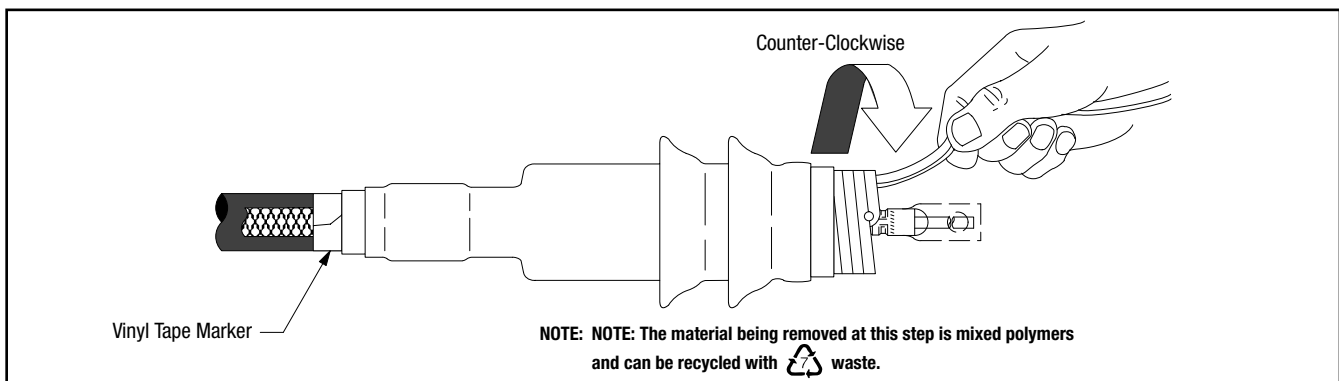
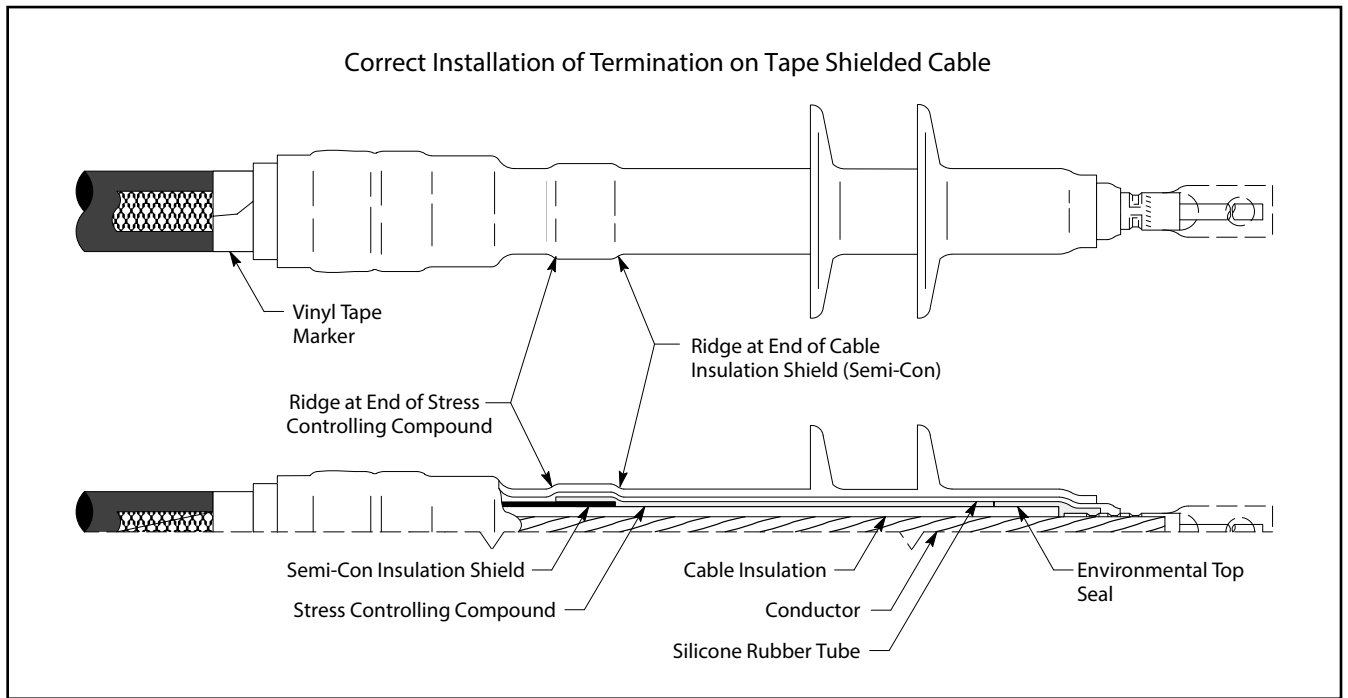

Figure 7

6.2 Connect ground braid to system ground according to standard practice.



Instructions for Wire Shielded Cable

7.0 Prepare Cable

7.1 Check to be sure cable size fits within kit range as shown in *Table 1*.

7.2 Prepare cable using dimensions shown in *Figure 8* and *Figure 9*. **BE SURE TO ALLOW FOR DEPTH OF TERMINAL LUG.**

NOTE: Provide additional 1/4" (6 mm) exposed conductor distance to account for growth during crimping of ALUMINUM lugs or connectors.

NOTE: It is imperative to remove all remnants of the semi-con layer, even if the semi-con layer comes off as one layer. There should not be any remaining black areas, or particles, on the cable insulation layer.

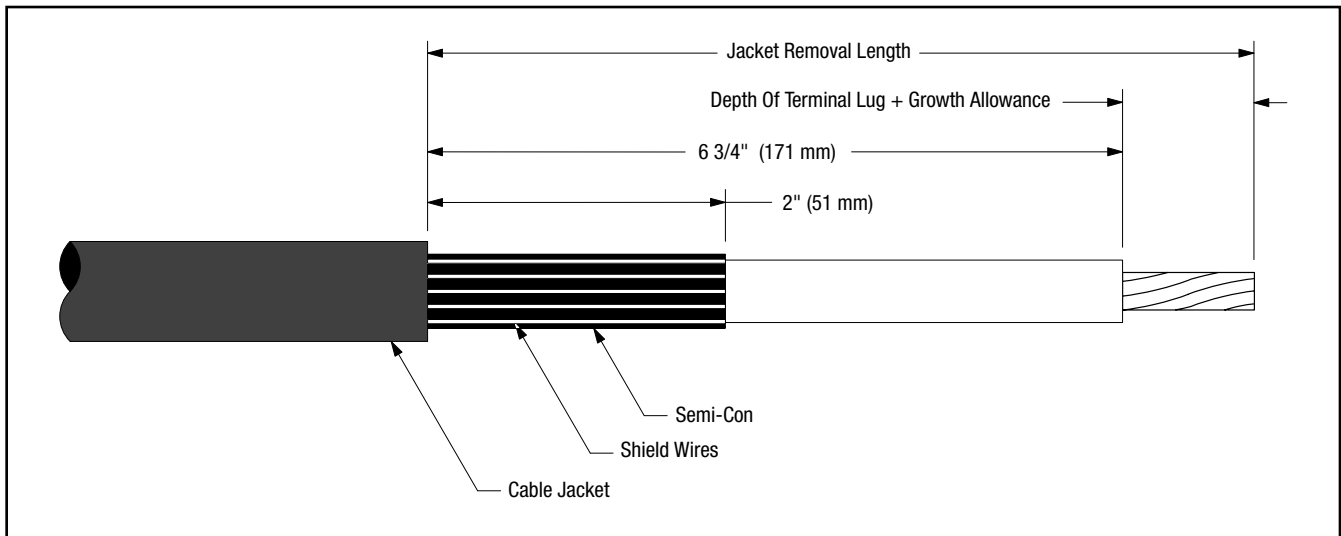

Figure 8

7.3 Bend leading 1" (25 mm) of exposed shield wires back upon themselves to jacket edge (*Figure 9*).

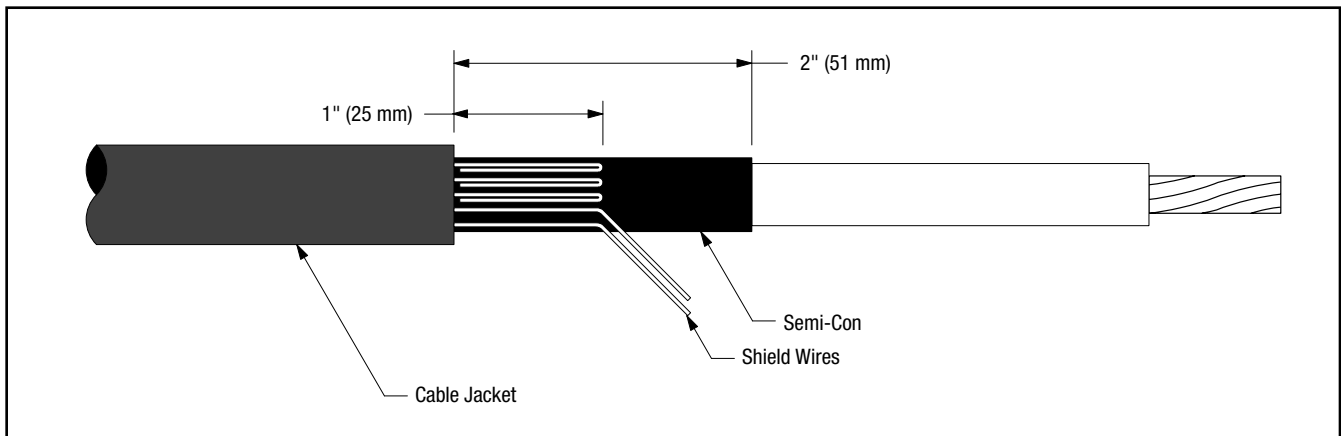

Figure 9

8.0 Install Ground Braid

- 8.1 Select a Scotch® Mastic Strip 2230 from kit and remove white release liners. Using light tension, apply a **SINGLE WRAP** of mastic around the cable jacket 1/4" (6 mm) from cut edge (*Figure 10*). Cut off excess.

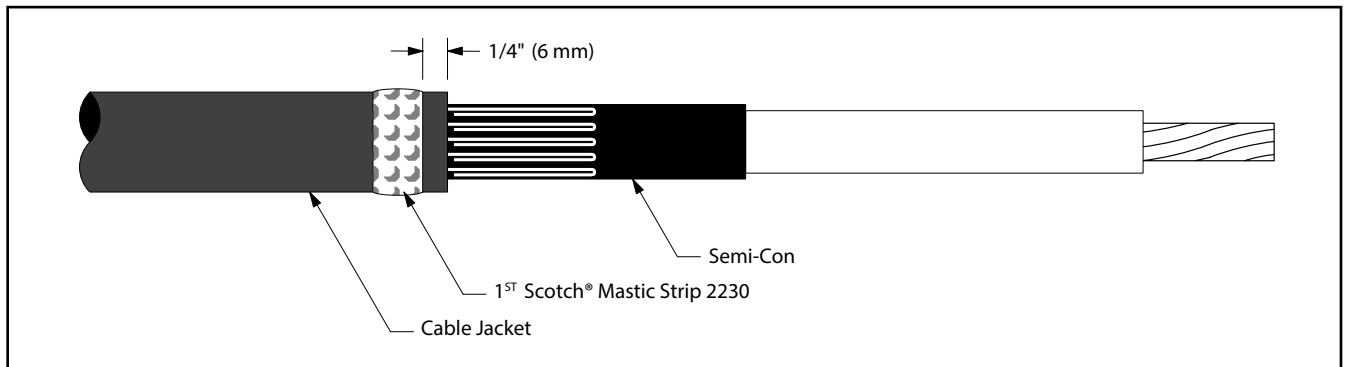

Figure 10

- 8.2 Position pre-formed ground braid with short tail over wire shield directly adjacent to cable jacket cut edge. Position long tail of ground braid, extending over cable jacket with solder block over mastic strip (*Figure 11*). Secure ground braid to cable jacket 3 1/2" (89 mm) from cable semi-con edge using vinyl tape (*Figure 11*).

NOTE: Position vinyl tape with care, it also serves as a marker for positioning the termination.

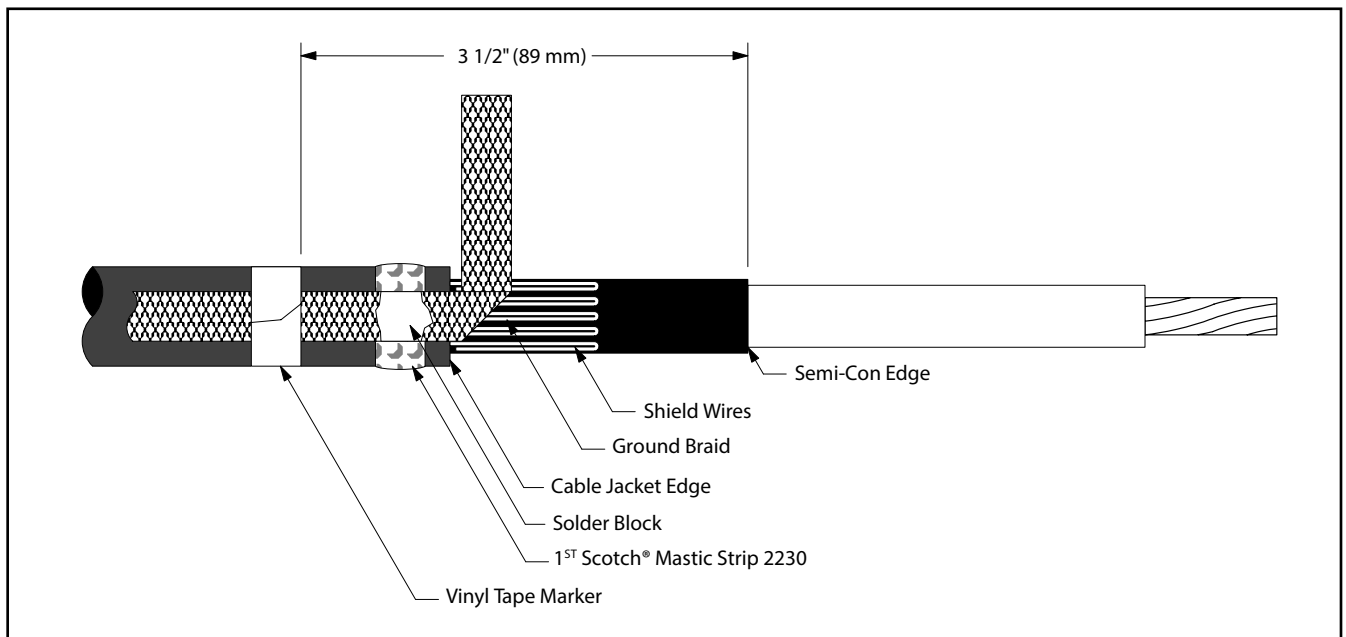

Figure 11

- 8.3 Wrap ground braid around cable shield wires one complete wrap, trim excess to prevent overlap and secure in place with constant force spring. Wrap spring in same direction as ground braid (*Figure 12*). Cinch (tighten) the spring after wrapping the final winding.
- 8.4 Select second Scotch® Mastic Strip 2230 from kit and remove white release liners. Apply a second **SINGLE WRAP** of mastic over solder block on ground braid and previously applied mastic (*Figure 12*). Cut off excess.

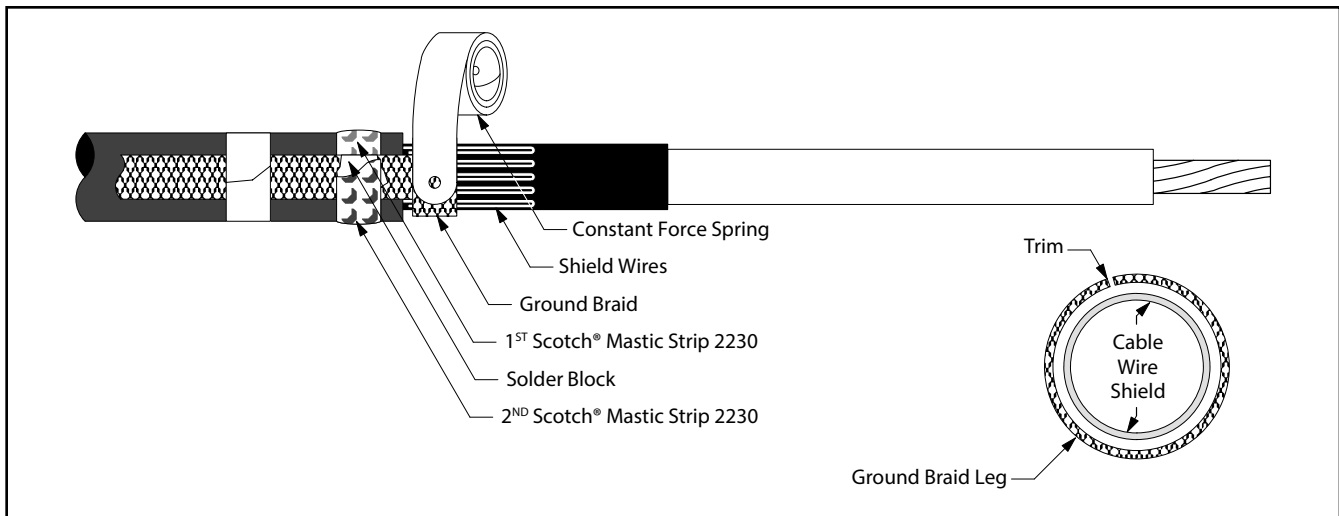

Figure 12

8.5 Wrap two highly stretched half-lapped layers of electrical grade vinyl tape around mastic seal, constant force spring and exposed shield wires (*Figure 13*).

NOTE: Take care not to cover exposed semi-con insulation shield. A minimum of 3/4" (19 mm) must be exposed.

SPECIAL NOTE FOR CLOTH OR PAPER SEMI-CON INSULATED SHIELD: In cables with cloth or paper semi-conductive shields, it is recommended the shield be over wrapped with one half-lapped layer of highly stretched semi-conductive rubber tape such as Scotch® Electrical Semi-Conducting Tape 13.

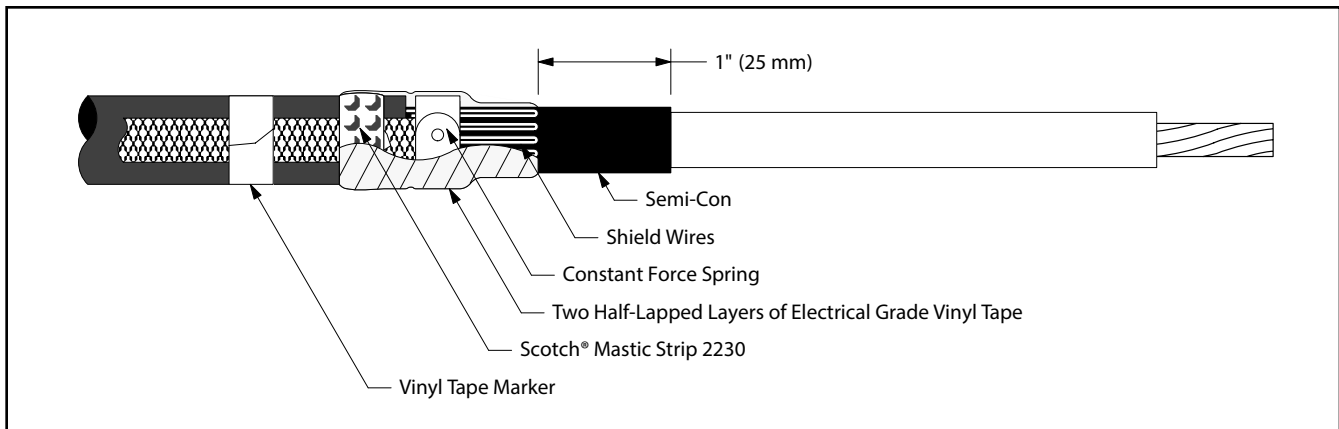

Figure 13

9.0 Install Lug or Connector

- 9.1 Check to insure the 3M™ Cold Shrink QT-III Silicone Rubber Termination assembly fits over the selected lug or connector. If lug or connector (*Figure 14*) will not fit through the termination core, clean the insulation (*per Step 10.0*) and slide termination on cable before installing lug or connector. **DO NOT REMOVE CORE AT THIS TIME.**

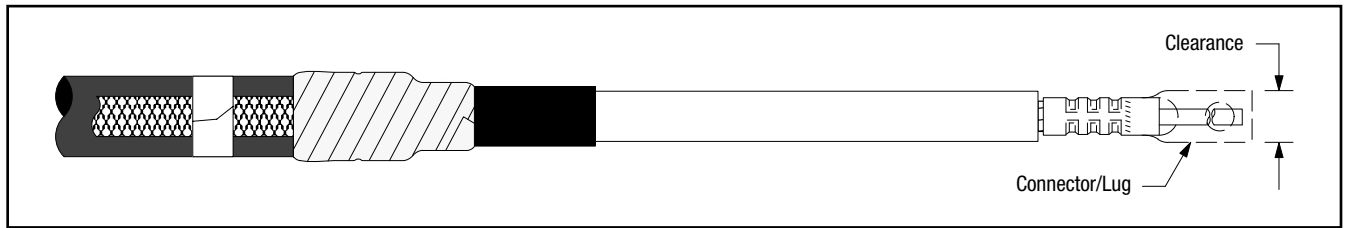

Figure 14

NOTE: Refer to pages 18 – 20 for 3M Connector and Lug crimping information.

- 9.2 Position connector or lug and crimp according to manufacturer's directions. Remove excess oxide inhibitor and sharp crimp flashings following crimping.

10.0 Clean Cable Insulation and Lug or Connector Barrel Using Standard Practice

- 10.1 Wipe the cable insulation with one of the solvent saturated pads from the 3M™ Cable Cleaning Preparation Kit CC-2. **DO NOT ALLOW SOLVENT TO TOUCH SEMI-CON INSULATION SHIELD!**
- 10.2 If abrasive must be used:
- Use on insulation only. **DO NOT USE ABRASIVE ON SEMI-CON INSULATION SHIELD!**
 - Use only aluminum oxide abrasive; grit 120 or finer, included in 3M™ Cable Cleaning Preparation Kit CC-2
 - Be careful not to reduce the cable insulation diameter below that allowed by the kit.

11.0 Install Termination

Important Packaging Notice

In order to make sure that you receive an undamaged termination, this 3M™ Cold Shrink QT-III Termination is packed with a RED SHIPPING CORE inside of the white core. Please remove the red shipping core BEFORE you install the termination. This shipping core can be recycled with other polypropylene waste.

- 11.1 Slide the termination body onto the cable and remove core. Pull while unwinding, counter-clockwise, starting with the loose end (*Figure 15*). Make sure the termination body (not the core) is butted up to the edge of the vinyl tape marker previously applied (*Figure 15*).

NOTE: Once the termination body makes contact over the mastic seal area, there is no need to continue supporting the assembly. **DO NOT PUSH OR PULL ON THE TERMINATION ASSEMBLY WHILE UNWINDING THE CORE.**

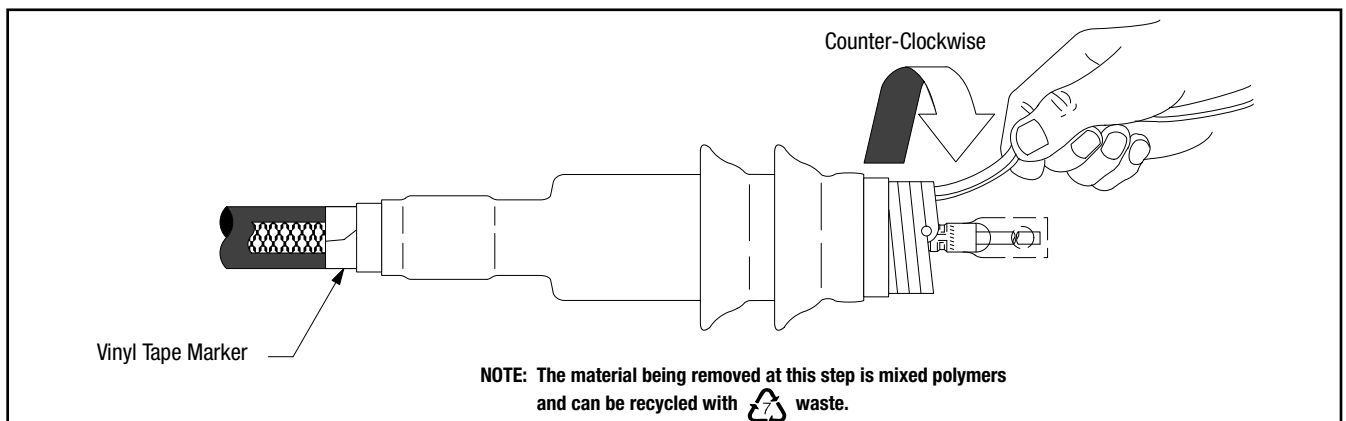
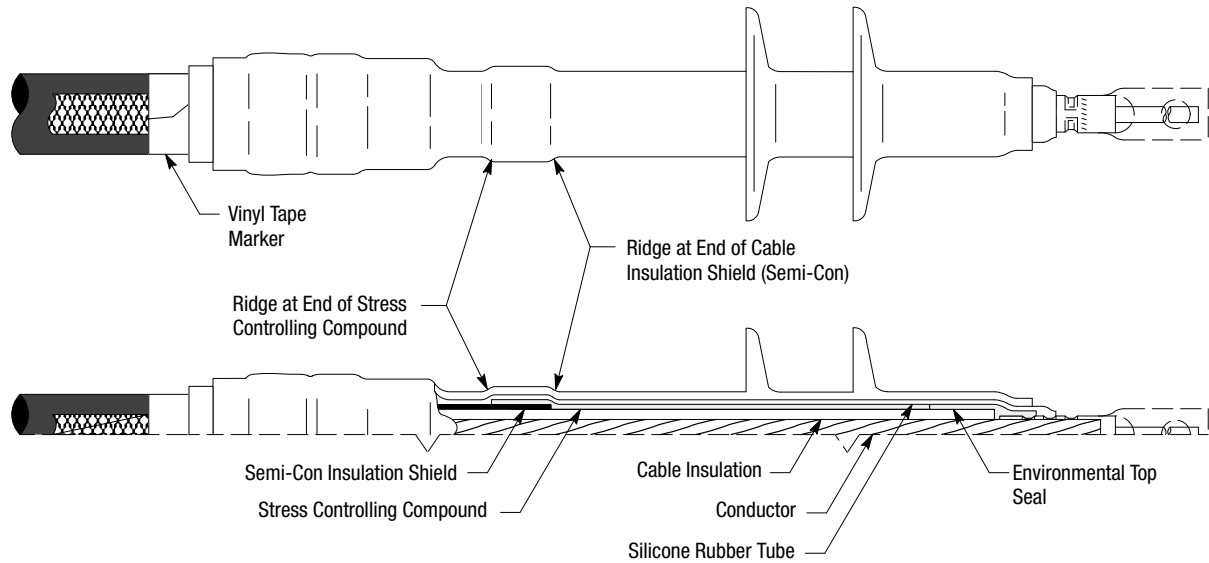

Figure 15

- 11.2 Connect ground braid to system ground according to standard practice.

Correct Installation of Termination on Wire Shielded Cable



Instructions for UniShield® Shielded Cable

12.0 Prepare Cable

12.1 Check to be sure cable size fits within kit range as shown in *Table 1*.

12.2 Prepare cable using dimensions shown in *Figures 16, 17 and 18*. **BE SURE TO ALLOW FOR DEPTH OF TERMINAL LUG.**

NOTE: Provide additional 1/4" (6 mm) exposed conductor distance to account for growth during crimping of ALUMINUM lugs or connectors.

12.3 Install constant force spring as shown in *Figure 16*. Pull shield wires through semi-conductive jacket to leading edge of constant force spring (*Figure 16*).

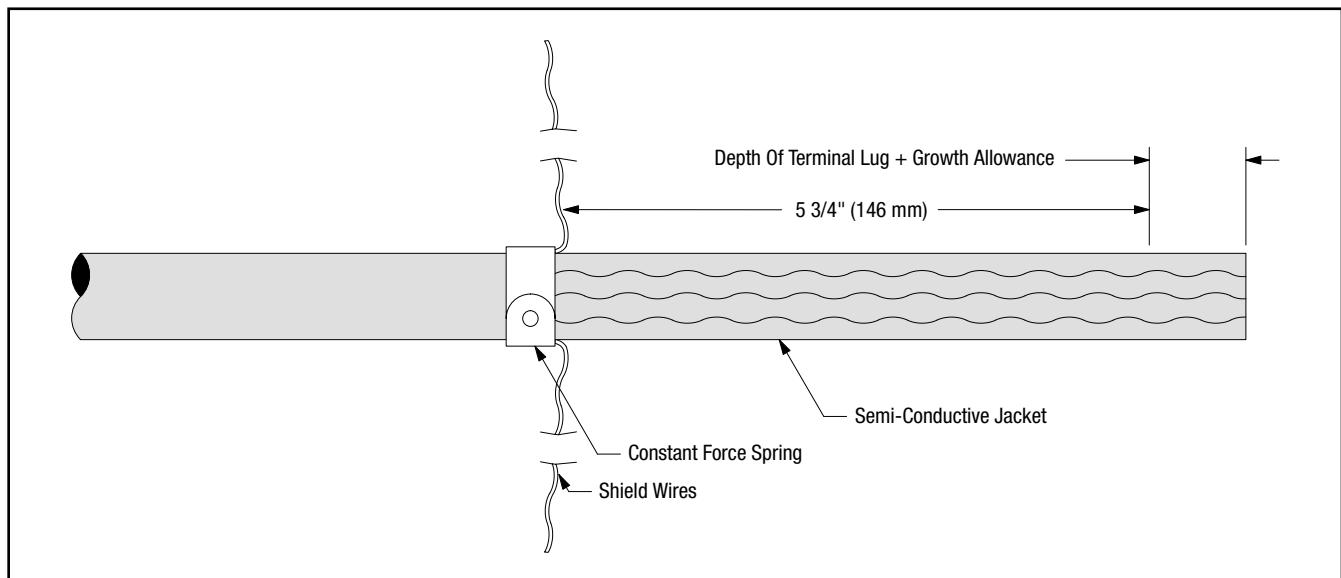

Figure 16

12.4 Remove constant force spring. Bend shield wires back upon cable jacket 1" (25 mm). Cut excess shield wire and discard (*Figure 17*).

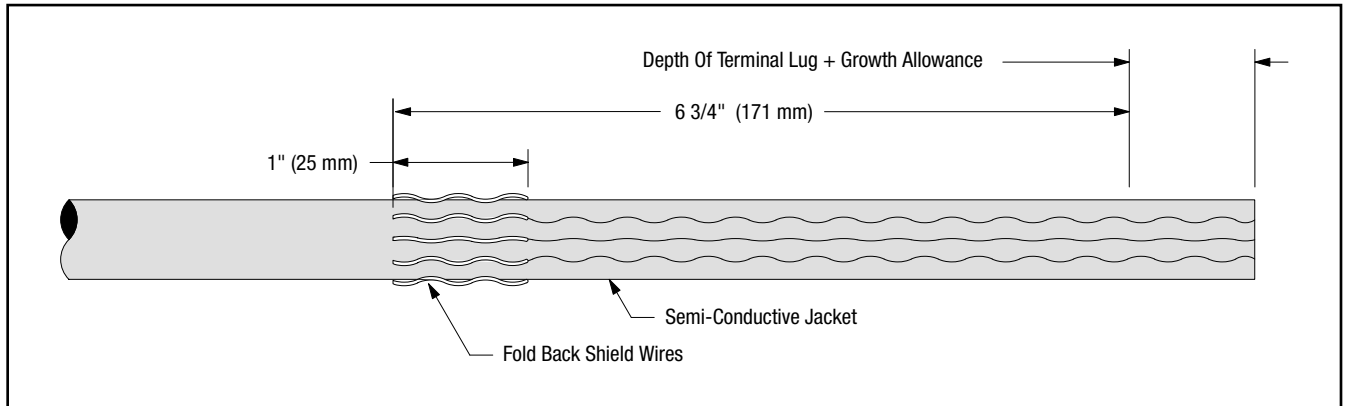

Figure 17

12.5 Remove semi-conductive jacket to dimension shown in *Figure 18*.

NOTE: To ease jacket removal, install constant force spring as shown in *Figure 18* and ring cut 80% through jacket. Remove jacket sections by pulling against constant force spring. **DO NOT BELL SEMI-CON JACKET.** Remove constant force spring.

NOTE: It is imperative to remove all remnants of the semi-conductive jacket, even if the semi-conductive jacket comes off as one layer. There should not be any remaining black areas, or particles, on the cable insulation layer.

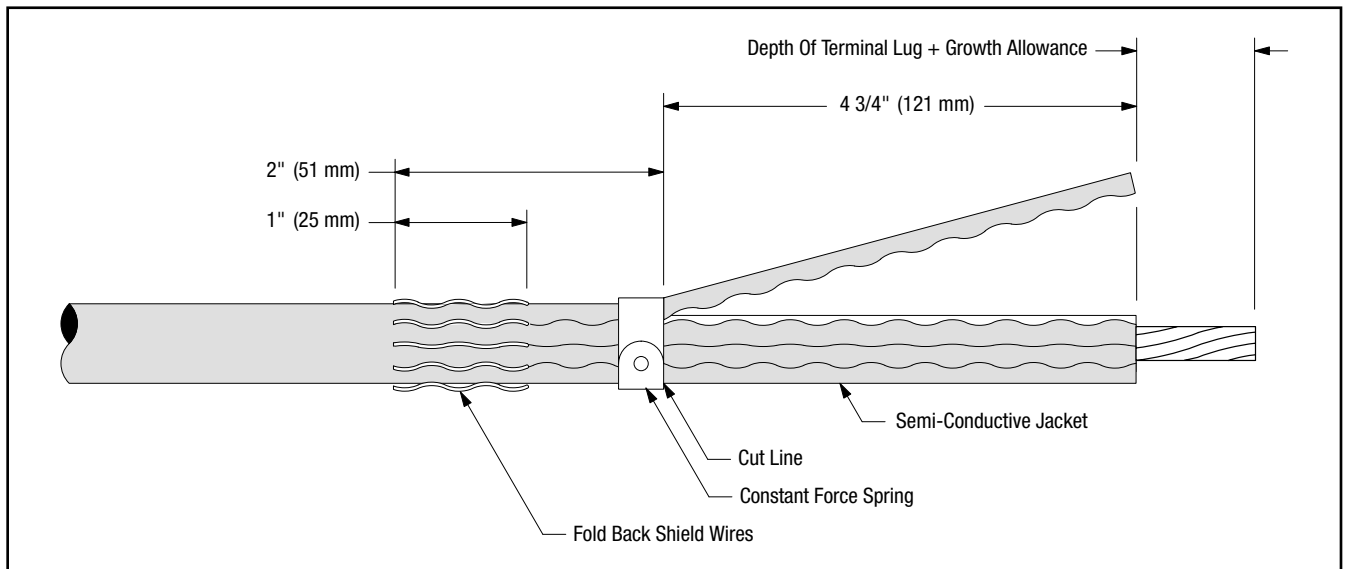

Figure 18

13.0 Install Ground Braid

- 13.1 Select a Scotch® Mastic Strip 2230 from kit and remove white release liners. Using light tension, apply a **SINGLE WRAP** of mastic around the cable semi-conductive jacket 1/4" (6 mm) from shield wires (*Figure 19*). Cut off excess.

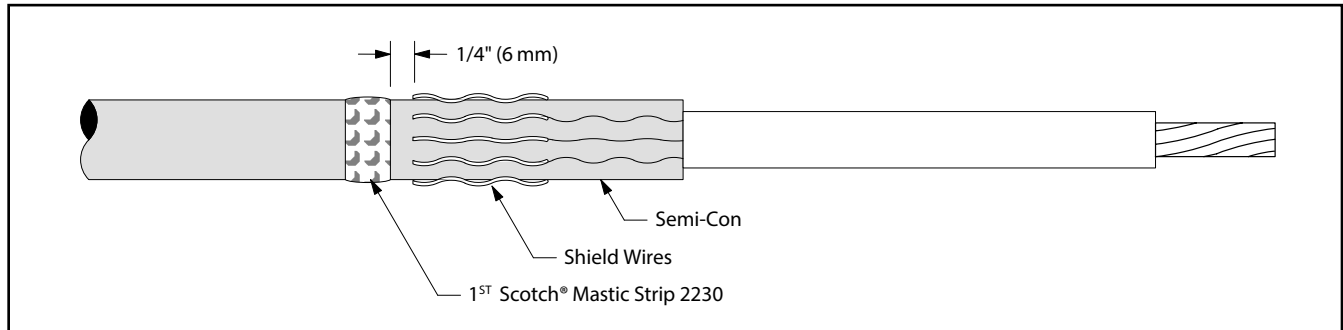

Figure 19

- 13.2 Position pre-formed ground braid with short tail directly over cut edge of folded back shield wires. Position long tail of ground braid, extending over cable semi-conductive jacket with solder block over mastic strip (*Figure 20*). Secure ground braid to cable semi-conductive jacket 3 1/2" (89 mm) from cable semi-con edge using vinyl tape (*Figure 20*).

NOTE: Position vinyl tape with care, it also serves as a marker for positioning the termination.

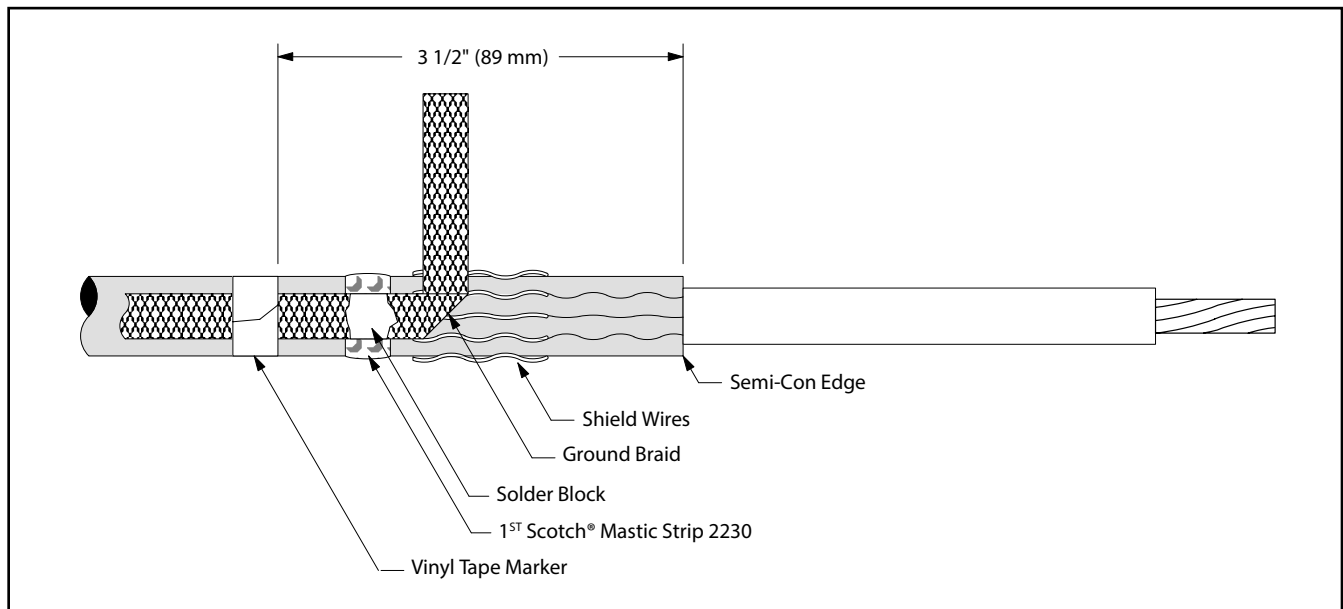

Figure 20

- 13.3 Wrap ground braid around cable shield wires one complete wrap, trim excess to prevent overlap and secure in place with constant force spring. Wrap spring in same direction as ground braid (*Figure 21*). Cinch (tighten) the spring after wrapping the final winding.

13.4 Select second Scotch® Mastic Strip 2230 from kit and remove white release liners. Apply a second **SINGLE WRAP** of mastic over solder block on ground braid and previously applied mastic (*Figure 21*). Cut off excess.

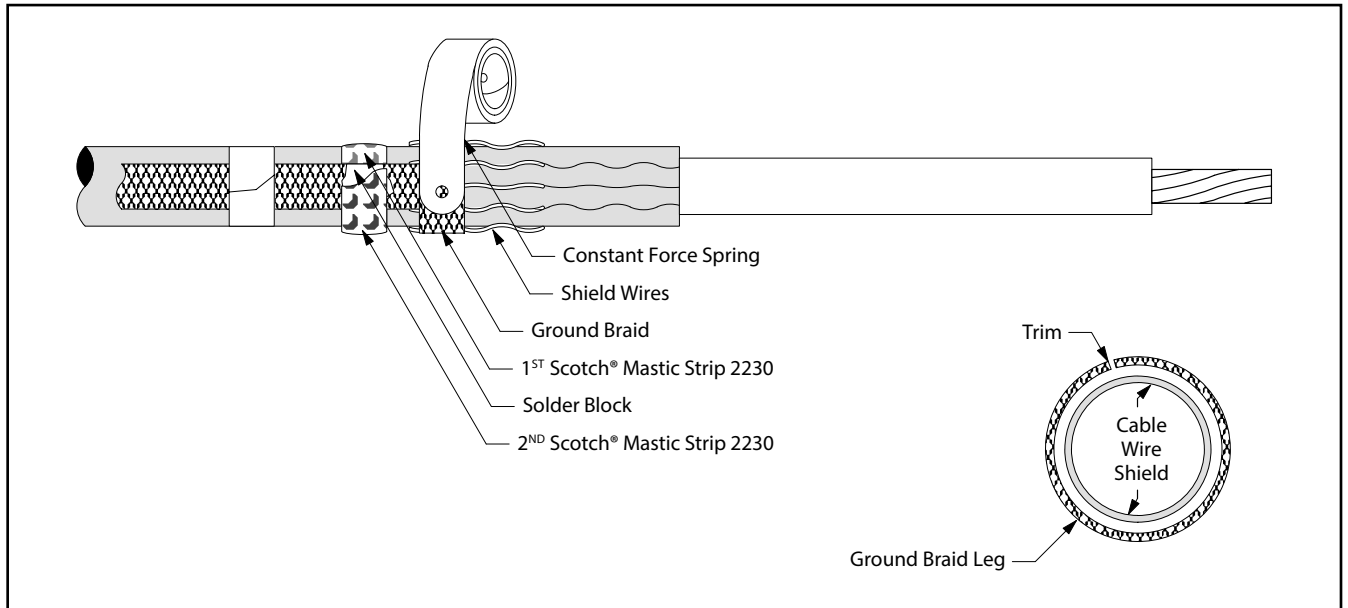

Figure 21

13.5 Wrap two highly stretched half-lapped layers of electrical grade vinyl tape around mastic seal, constant force spring and exposed shield wires (*Figure 22*).

NOTE: Take care not to cover exposed semi-con insulation shield. A minimum of 3/4" (19 mm) must be exposed.

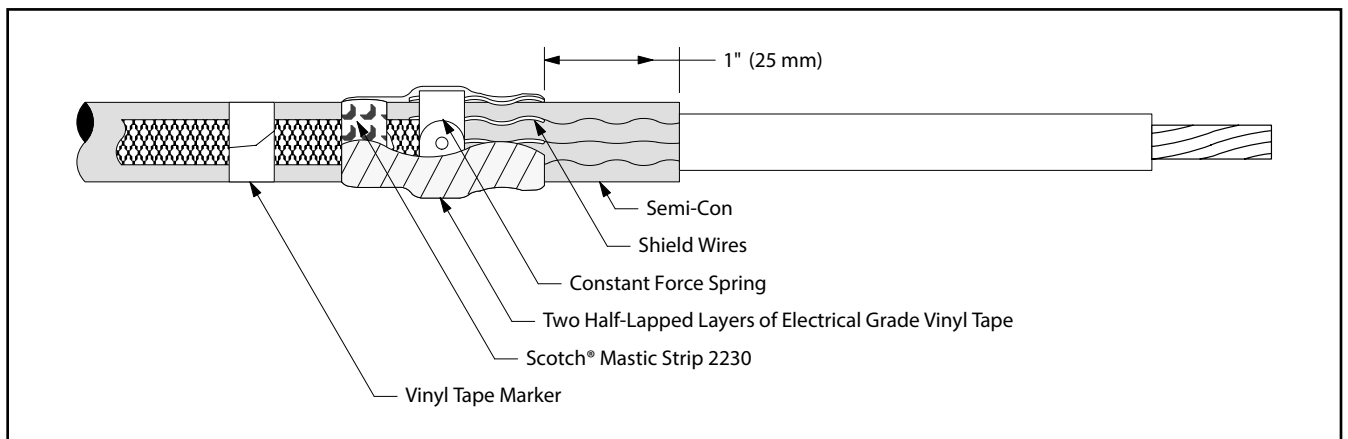

Figure 22

14.0 Install Lug or Connector

- 14.1 Check to insure the 3M™ Cold Shrink QT-III Silicone Rubber Termination assembly fits over the selected lug or connector. If lug or connector (*Figure 23*) will not fit through the termination core, clean the insulation (*per Step 15.0*) and slide termination on cable before installing lug or connector. **DO NOT REMOVE CORE AT THIS TIME.**

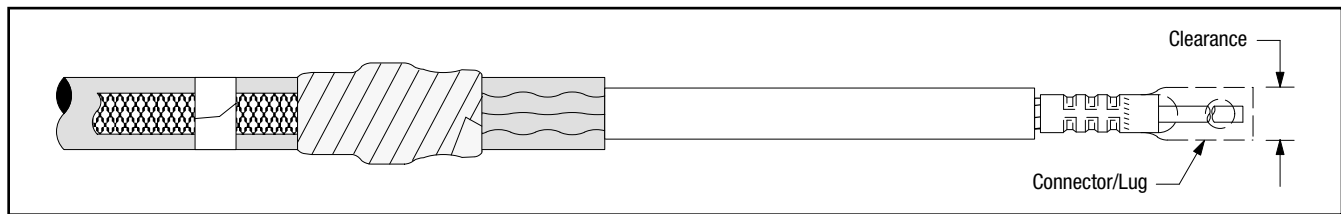

Figure 23

NOTE: Refer to pages 18 – 20 for 3M Connector and Lug crimping information.

- 14.2 Position connector or lug and crimp according to manufacturer's directions. Remove excess oxide inhibitor and sharp crimp flashings following crimping.

15.0 Clean Cable Insulation and Lug or Connector Barrel Using Standard Practice

- 15.1 Wipe the cable insulation with one of the solvent saturated pads from the 3M™ Cable Cleaning Preparation Kit CC-2. **DO NOT ALLOW SOLVENT TO TOUCH SEMI-CON INSULATION SHIELD!**
- 15.2 If abrasive must be used:
- Use on insulation only. **DO NOT USE ABRASIVE ON SEMI-CON INSULATION SHIELD!**
 - Use only aluminum oxide abrasive; grit 120 or finer, included in 3M™ Cable Cleaning Preparation Kit CC-2.
 - Be careful not to reduce the cable insulation diameter below that allowed by the kit.

16.0 Install Termination

Important Packaging Notice

In order to make sure that you receive an undamaged termination, this 3M™ Cold Shrink QT-III Termination is packed with a RED SHIPPING CORE inside of the white core. Please remove the red shipping core BEFORE you install the termination. This shipping core can be recycled with other polypropylene waste.

- 16.1 Slide the termination body onto the cable and remove core. Pull while unwinding, counter-clockwise, starting with the loose end (*Figure 24*). Make sure the termination body (not the core) is butted up to the edge of the vinyl tape marker previously applied (*Figure 24*).

NOTE: Once the termination body makes contact over the mastic seal area, there is no need to continue supporting the assembly. **DO NOT PUSH OR PULL ON THE TERMINATION ASSEMBLY WHILE UNWINDING THE CORE.**

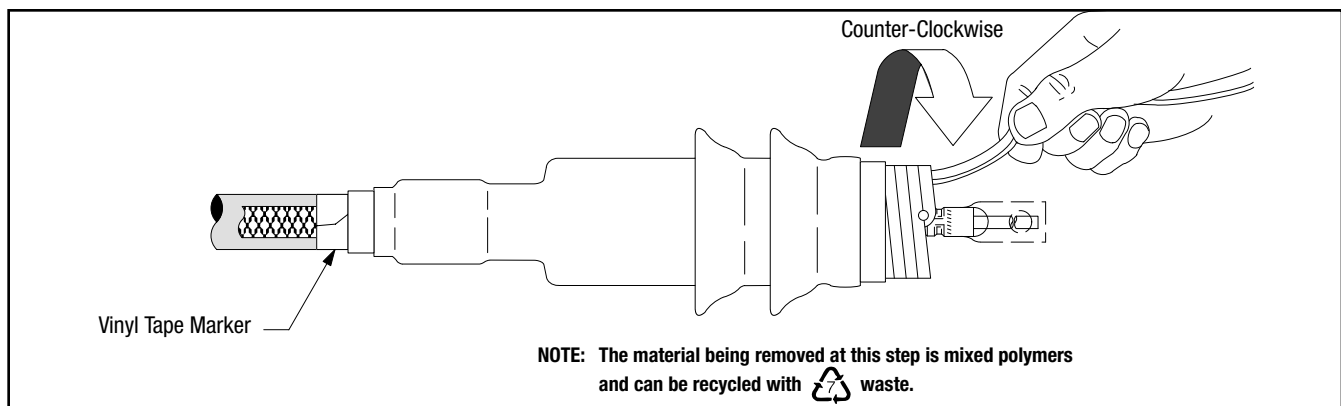
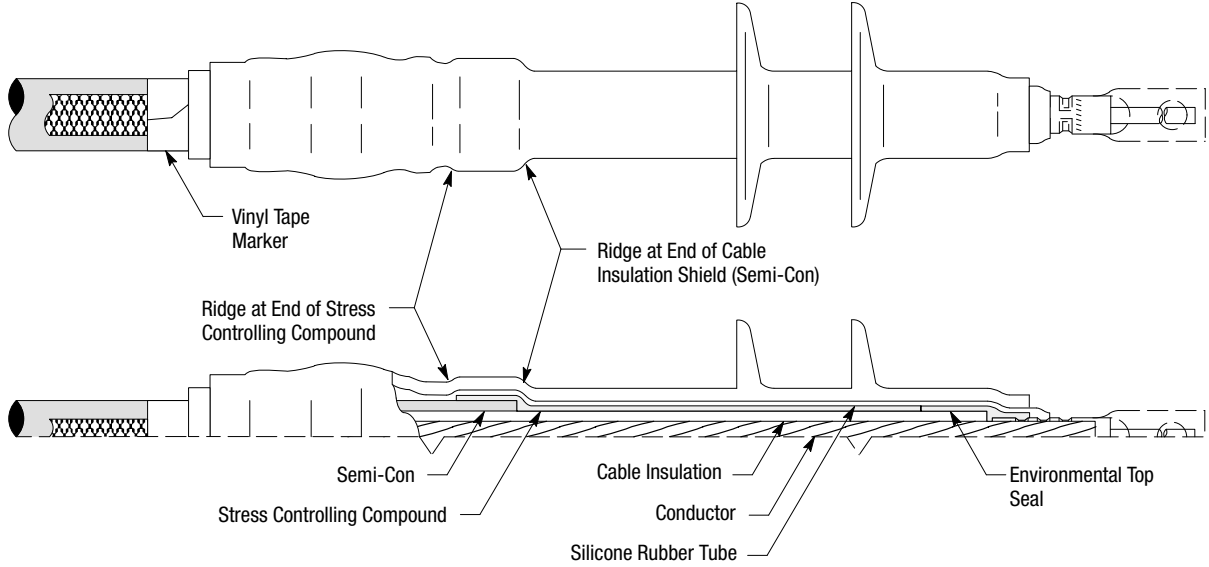

Figure 24

- 16.2 Connect ground braid to system ground according to standard practice.

Correct Installation of Termination on UniShield® Shielded Cable

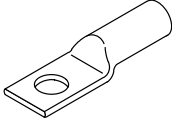
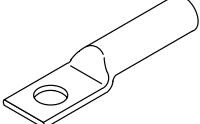
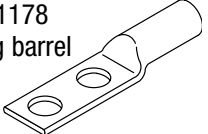

Tooling Index

Lug and Crimping Information for 3M™ Scotchlok™ Copper Lugs										
30014 thru 30045 One hole 			31036 thru 31068 One hole-long barrel 				31145 thru 31178 Two hole-long barrel 			
Crimping Tool-Die Sets (Minimum Number Of Crimps)										
Cable Size AWG/ kcmil	Stud Size (in.)	3M™ Scotchlok™ Copper Lug Number	Burdny Corporation				Thomas & Betts Corporation			Square D Co. Anderson Div.
			MD6	MY29	Y34A	Y35, Y39, Y45*, Y46*	TBM 5	TBM 8	TBM 15	VC6-3, VC6-FT**
6	10 1/4 5/16	30014 30015 30016	-	6AWG(1)	-	U5CRT(1)	Blue(1)	Blue(1)	-	(1)
4	10 1/4 3/8	30018 30019 30021	W161(1)	4AWG(1)	A4CR(1)	U4CRT(1)	Grey(1)	Grey(1)	-	(1)
2	1/4 5/16 3/8	30022 30023 30024	W162(2)	2AWG(1)	A2CR(1)	U2CRT(2)	Brown(1)	Brown(1)	33(1)	(2)
1	5/16 3/8	30027 30028	-	1AWG(1)	A1CR(1)	U1CRT(2)	Green(1)	Green(1)	37(1)	(2)
1/0	5/16 3/8	30031 30032	W163(2)	1/0(1)	A25R(1)	U25RT(1)	Pink(2)	Pink(2)	42H(2)	(1)
2/0	3/8 3/8	30036 31036	W241(2) W241(3)	2/0(1) 2/0(2)	A26R(1) A26R(2)	U26RT(2) U26RT(3)	Black(2) Black(3)	Black(2) Black(3)	45(1) 45(2)	(1) (2)
3/0	1/2 1/2	30041 31041	W243(2) W243(3)	3/0(1) 3/0(2)	A27R(1) A27R(2)	U27RT(2) U27RT(3)	Orange(2) Orange(3)	Orange(2) Orange(3)	50(1) 50(2)	(2) (3)
4/0	1/2 1/2 1/2	30045 31045 31145	BG(3) BG(4) BG(4)	4/0(1) 4/0(2) 4/0(2)	A28R(2)	U28RT(2) U28RT(3) U28RT(3)	Purple(2) Purple(3) Purple(3)	Purple(2) Purple(3) Purple(3)	54H(2) 54H(3) 54H(3)	(2) (3) (3)
250	1/2 1/2	31049 31149	W166(4)	250(2)	A29R(2)	U29RT(3)	Yellow(2)	Yellow(2)	62(2)	(2)
300	1/2 1/2	31053 31153	-	-	A30R(2)	U30RT(3)	-	White(3)	66(3)	(3)
350	1/2 1/2	31056 31156	-	-	A31R(2)	U31RT(3)	-	Red(4)	71H(4)	-
400	1/2 1/2	31060 31160	-	-	A32R(2)	U32RT(3)	-	Blue(4)	76H(4)	-
500	1/2 5/8 1/2	31066 31067 31166	-	-	A34R(2)	U34RT(3)	-	Brown(4)	87H(4)	-
600	1/2 1/2	31068 31168	-	-	-	U36RT(3)	-	Green(4)	94H(4)	-
750	1/2	31172	-	-	-	Y39, Y45, Y46 U39RT(5)	-	-	106H(4)	-
1000	1/2	31178	-	-	-	Y45: S44RT(6) Y46: P44RT(6)	-	-	125H(4)	-

* Y45 and Y46 accept all Y35 dies ("U" series). For Y45 use PT6515 adapter. For Y46 use PUADP adapter.

** Anderson VC6-3 and VC6-FT require no die set.

Tooling Index

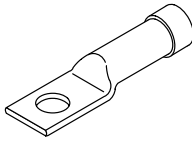
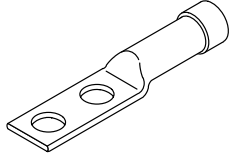
Lug and Crimping Information for 3M™ Scotchlok™ Copper/Aluminum Lugs																
40016 thru 40079 One hole									40132 thru 40178 Two hole							
Cable Size AWG/ kcmil	Stud Size (in.)	3M™ Scotchlok™ Lug Number	Crimping Tool-Die Sets (Minimum Number Of Crimps)													
			Burdny Corporation						Thomas & Betts Corporation				Square D Co. Anderson Div.		ITT Blackburn Co.	Kearny Nat'l Div.
			MD6	MY29	Y34A	Y35, Y39, Y45*, Y46*	Y1000**	TBM 5	TBM 8	TBM 12	TBM 15	VC6-3** VC6-FT**	VC8C**	OD58	TYPE 0	
6	5/16	40016	W161(1)	6AWG(1)	A6CAB(1)	U6CABT(1)	(1)	Grey(1)	Grey(1)	-	29(1)	(1)	-	BY19(3)	J(3)	
4	5/16	40020	W162(3)	4AWG(1)	A4CAB(1)	U4CABT(1)	(1)	Green(2)	Green(2)	-	37(1)	(1)	-	BY53(3)	P(3)	
2	3/8	40024	W163(3)	2AWG(1)	A2CAB(1)	U2CABT(1)	(1)	Pink(2)	Pink(2)	-	42H(2)	(1)	-	BY23(3)	1/2(3)	
	1/2	40025	W163(3)	2AWG(1)	A2CAB(1)	U2CABT(1)	(1)	Pink(2)	Pink(2)	-	42H(2)	(1)	-	BY23(3)	1/2(3)	
1	3/8	40028	W163(3)	1AWG(1)	A1CAR(1)	U1CART(1)	(1)	Gold(2)	Gold(2)	-	45(1)	(1)	-	BY23(3)	1/2(3)	
	1/2	40029	W163(3)	1AWG(1)	A1CAR(1)	U1CART(1)	(1)	Gold(2)	Gold(2)	-	45(1)	(1)	-	BY23(3)	1/2(3)	
1/0	3/8	40032	W241(3)	1/0(1)	A25AR(1)	U25ART(1)	(1)	Tan(2)	Tan(2)	-	50(1)	(1)	-	BY25(3)	5/8-1(3)	
	1/2	40033	W241(3)	1/0(1)	A25AR(1)	U25ART(1)	(1)	Tan(2)	Tan(2)	-	50(1)	(1)	-	BY25(3)	5/8-1(3)	
	3/8	40132	W241(3)	1/0(1)	A25AR(1)	U25ART(1)	(1)	Tan(2)	Tan(2)	-	50(1)	(1)	-	BY25(3)	5/8-1(3)	
2/0	1/2	40037	BG(4)	2/0(1)	A26AR(2)	U26ART(2)	(1)	Olive(2)	Olive(2)	-	54H(2)	(2)	-	BY31C(3)	5/8-1(3)	
	1/2	40137	BG(4)	2/0(1)	A26AR(2)	U26ART(2)	(1)	Olive(2)	Olive(2)	-	54H(2)	(2)	-	BY31C(3)	5/8-1(3)	
3/0	1/2	40041	W166(4)	3/0(1)	A27AR(2)	U27ART(2)	(1)	Ruby(2)	Ruby(2)	-	60(2)	(2)	-	-	737(3)	
	1/2	40141	W166(4)	3/0(1)	A27AR(2)	U27ART(2)	(1)	Ruby(2)	Ruby(2)	-	60(2)	(2)	-	-	737(3)	
4/0	1/2	40045	W660(4)	4/0 (2)	A28AR(2)	U28ART(2)	(1)	-	White(4)	-	66(4)	(2)	-	BY35C(4)	840(4)	
	5/8	40046	W660(4)	4/0 (2)	A28AR(2)	U28ART(2)	(1)	-	White(4)	-	66(4)	(2)	-	BY35C(4)	840(4)	
	1/2	40145	W660(4)	4/0 (2)	A28AR(2)	U28ART(2)	(1)	-	White(4)	-	66(4)	(2)	-	BY35C(4)	840(4)	
250	1/2	40049	W249(3)	-	A29AR(2)	U29ART(2)	(1)	-	-	71H(4)	71H(2)	(3)	-	-	-	
	5/8	40050	W249(3)	-	A29AR(2)	U29ART(2)	(1)	-	-	71H(4)	71H(2)	(3)	-	-	-	
	1/2	40149	W249(3)	-	A29AR(2)	U29ART(2)	(1)	-	-	71H(4)	71H(2)	(3)	-	-	-	
300	1/2	40053	-	-	A30AR(2)	U30ART(2)	(1)	-	-	76H(4)	76H(2)	(3)	-	-	-	
	1/2	40153	-	-	A30AR(2)	U30ART(2)	(1)	-	-	76H(4)	76H(2)	(3)	-	-	-	
350	1/2	40056	-	-	-	U31ART(2)	(1)	-	-	87H(4)	87H(3)	(3)	-	-	-	
	5/8	40057	-	-	-	U31ART(2)	(1)	-	-	87H(4)	87H(3)	(3)	-	-	-	
	1/2	40156	-	-	-	U31ART(2)	(1)	-	-	87H(4)	87H(3)	(3)	-	-	-	
400	1/2	40160	-	-	-	U32ART(4)	(1)	-	-	94H(4)	94H(4)	-	(2)	-	-	
500	5/8	40067	-	-	-	U34ART(4)	(1)	-	-	106H(4)	106H(3)	-	(2)	-	-	
	1/2	40166	-	-	-	U34ART(4)	(1)	-	-	106H(4)	106H(3)	-	(2)	-	-	
600	1/2	40170	-	-	-	U36ART(4)	(1)	-	-	-	115H(3)	-	(3)	-	-	
750	5/8	40073	-	-	-	U39ART(4)	(1)	-	-	-	125H(4)	-	(3)	-	-	
	1/2	40172	-	-	-	U39ART(4)	(1)	-	-	-	125H(4)	-	(3)	-	-	
1000	5/8	40079	-	-	-	S44ART(4)	(1)	-	-	-	140H(4)	-	(3)	-	-	
	1/2	40178	-	-	-	S44ART(4)	(1)	-	-	-	140H(4)	-	(3)	-	-	

* Y45 and Y46 accept all Y35 dies ("U" series). For Y45 use PT6515 adapter. For Y46 use PUADP adapter.

** Anderson VC6-3, VC6-FT, VC8C and Burdny Y1000 require no die set.

Tooling Index

Crimping Information for
3M™ Stem Connectors
Copper/Aluminum

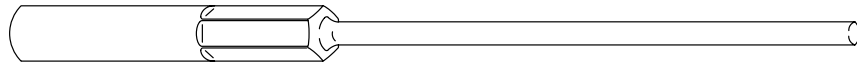

Conductor Size AWG & kcmil		3M™ Connector Number	Crimping Table For 3M™ Stem Type Connector				
Stranded	Solid		Recommended Crimping Tools				
			Manufacturer	Mech. Tool	Die (Minimum No. Crimps)	Hydraulic	Die (Minimum No. Crimps)
2, 1 4 1/0	1, 1/0 2 2/0	SC0001 SC0002 SC0010	Burndy	MD6	BG(4), W243(4)	Y35, Y39, Y45*	U25ART(2), U243(2)
			Kearny	0-51, 0-52	5/8-1 (4)	12, 20, 40, Ton	5/8-1(4)
			T & B	TBM 5	Tan(2)	-	-
			T & B	TBM 8	Olive(2)	TBM 15	50(2)
			Anderson	-	-	VC6	(2)
2/0 3/0 4/0	3/0 4/0 -	SC0020 SC0030 SC0040	Burndy	MD6	W669(0) 840(5)	Y35, Y39, Y45*	U28ART(2)
			Kearny	0-51, 0-52	840(5)	WH-1, WH-2	840(2)
			T & B	TBM 8	White(4)	TBM 15	66H(3)
			Anderson	-	-	VC6	(2)

* Y45 and Y46 accept all Y35 dies ("U" series). For Y45 use PT6515 adapter. For Y46 use PUADP adapter.

** Anderson VC6 is dieless and does not require a die set.

3M, Scotch and Scotchlok are trademarks of 3M Company.
UniShield is a trademark of General Cable Technologies Corporation.

Important Notice

All statements, technical information, and recommendations related to 3M's products are based on information believed to be reliable, but the accuracy or completeness is not guaranteed. Before using this product, you must evaluate it and determine if it is suitable for your intended application. You assume all risks and liability associated with such use. Any statements related to the product which are not contained in 3M's current publications, or any contrary statements contained on your purchase order shall have no force or effect unless expressly agreed upon, in writing, by an authorized officer of 3M.

Warranty; Limited Remedy; Limited Liability.

This product will be free from defects in material and manufacture at the time of purchase. **3M MAKES NO OTHER WARRANTIES INCLUDING, BUT NOT LIMITED TO, ANY IMPLIED WARRANTY OF MERCHANTABILITY OR FITNESS FOR A PARTICULAR PURPOSE.** If this product is defective within the warranty period stated above, your exclusive remedy shall be, at 3M's option, to replace or repair the 3M product or refund the purchase price of the 3M product. **Except where prohibited by law, 3M will not be liable for any indirect, special, incidental or consequential loss or damage arising from this 3M product, regardless of the legal theory asserted.**

Electrical Markets Division

6801 River Place Blvd.
Austin, TX 78726-9000
800.245.3573
Fax 800.245.0329
www.3M.com/electrical

Please Recycle. Printed in USA.
© 3M 2013. All Rights Reserved.
78-8117-0508-2 Rev D