



Science.  
Applied to Life.™



ID 2245780  
RID 2244163

# Reusable Respirators

Half and Full Facepiece respirators by 3M offer exceptional value and quality, all combine comfort with ease of use. The choice of the right facepiece and filter type depends on your particular working environment and individual requirements. 3M can assist you to choose the protection that helps you achieve optimum results.

# Types of respiratory protection equipment (RPE) from 3M.

Key types of RPE available from 3M:



### Filtering Facepiece/Disposable Respirators

- Ideal for most industries and applications where wearers require particulate protection e.g. dusts and mists
- A choice of cup-shape or flat-fold, valved or unvalved and also the option to protect against ozone and nuisance\* levels of organic vapours and acid gases
- Lightweight and maintenance free
- Comfortable, convenient and easy to use



### Reusable Half and Full Facepiece Respirators

- Offer protection against particulates, gases and vapours and combinations of the two
- These respirators have integrated or replaceable filters and parts. They may be cleaned, stored and reused provided they are in good condition
- Full facepiece respirators also offer integrated eye and face protection
- Many models are fully maintainable



### Powered Air & Supplied Air Systems

- Offer protection against dusts, mists, fumes, gases, vapours and combination hazards e.g. paint spray
- Can offer integrated eye, face, head, neck and hearing protection in one system avoiding incompatibility issues between items of PPE
- Modular system allows you to mix and match parts as your environment or application changes, giving you the ultimate in flexibility and ease of use
- No increase in breathing resistance means more comfortable and longer wear time
- Loose fitting headtops/hoods usable by a wide range of users regardless of facial characteristics; shape, size etc.

\* Nuisance levels are those levels below the Workplace Exposure Standard (WES)/Workplace Exposure Limit (WEL).

# Types of respirators and protection factors.



The higher the exposure the greater the protection and reduction in exposure required.

In AS/NZS 1715, different combinations of respirators are assigned a required minimum protection factor (RMPF) for clean shaven, fit tested and trained wearers. The RMPF is the minimum reduction in exposure required to reduce the wearers exposure beneath the Workplace Exposure Standard (WES). Ideally the wearers exposure is reduced well below the WES.

The RMPF is based on the characteristics of the respirator in question such as:

1. Air Purifying or Air supplied?
2. Positive or negative pressure?
3. Tight fitting facepiece or loose fitting head top?
4. Sealing area of the tight fitting facepiece – half face or full face?
5. Rating of the filter and class of the cartridge?

Examples of, but not limited to, respirator and filter combinations

<b>RMPF 100+</b>	<ul style="list-style-type: none"> <li>• Self Contained Breathing Apparatus (SCBA) positive pressure demand.</li> <li>• Powered Air Purifying Respirator (PAPR) with Class PAPR-P3 particulate filter with a full facepiece.</li> <li>• Full facepiece or headcovering with airline respirator supplied air continuous flow.</li> </ul>		<p>100x + WES</p>
<b>RMPF Up to 100</b> or up to 5000 ppm	<ul style="list-style-type: none"> <li>• Full face reusable respirators with P3 particulate filter.</li> <li>• Full Facepiece Reusable respirators with Class 2 gas and vapour cartridge or up to 5000 ppm.</li> </ul>		<p>100x WES</p>
<b>RMPF Up to 50</b> or up to 1000 ppm or 5000 ppm	<ul style="list-style-type: none"> <li>• Full Facepiece Reusable respirators with P2 particulate filter.</li> <li>• Powered Air Purifying Respirator (PAPR) with Class PAPR-P2 particulate filter with any headcovering or full facepiece.</li> <li>• Powered Air Purifying Respirator (PAPR) with Class PAPR-P3 particulate filter with any headcovering.</li> <li>• Full Facepiece Reusable respirators with Class Aus or Class 1 gas and vapour cartridge or up to 1000ppm.</li> </ul>		<p>50x WES</p>
<b>RMPF Up to 10</b> or up to 1000 ppm	<ul style="list-style-type: none"> <li>• Disposable respirators P1 or P2.</li> <li>• Half face Reusable respirators with P1, P2, P3 Particulate Filter</li> <li>• Class AUS, 1, 2, 3 gas &amp; vapour cartridge or up to 1000ppm.</li> <li>• Powered Air Purifying Respirator (PAPR) with Class PAPR-P1 particulate filter with any headcovering.</li> <li>• Powered Air Purifying Respirator (PAPR) with Class PAPR-AUS, 1, 2 Gas &amp; vapour cartridge with any headcovering or facepiece or up to 1000ppm.</li> </ul>		<p>10x WES</p>
<b>Nuisance Level Exposure</b>		Action Level - 50% of WES to implement controls	

Increasing Protection Factor

Workplace Exposure Standard (WES)

NOTE: Where worker exposure to contaminants could be immediately dangerous to life or health (IDLH), or exposure levels are unknown or there is an oxygen deficient environment you must refer to Section 4.2.7 Table 4.6 in AS/NZS 1715 for further guidance.

3M On-Demand Webinar Series

## Basics of Respiratory Protection

Learn how to choose the right respirators for your workplace environment.

ID 2013353  
RID 2013659

# Safeguard your workforce with the correct respiratory protection solution.

When respiratory protection systems are optimised for comfort, workers can focus on the work.

Our extensive respirator portfolio is engineered for versatility and built to protect. Find the right 3M™ Respirator that delivers optimal protection and lasting comfort for your needs.

Watch our three-part on-demand webinar series hosted by Mark Reggers, Certified Occupational Hygienist (COH MAIOH) and Specialist Application Engineer for 3M Australia and New Zealand in the 3M Personal Safety Division.



### Part 1: Respiratory Protection Selection

From gases and vapours to particulates, each hazard requires a unique respiratory protection solution. Select a 3M respirator that works for your employees.



Scan or Click to watch



### Part 2: Types of Respiratory Protection

Prioritise comfort and versatile protection with a wide range of respirators from 3M – disposable /filtering facepiece, reusable respirators, powered and supplied air respirator systems, industrial SCBAs.



Scan or Click to watch



### Part 3: Importance of Fit & Fit Testing

Unlock the maximum potential of your respirators. Learn the best practices for fit testing, care, storage, and maintenance.



Scan or Click to watch

If you require any assistance in your workplace with respiratory protection or any PPE selection, contact 3M Customer Service or your local 3M representative.



Click or Scan for all available 3M Australia and New Zealand webinars

# 3M™ Reusable Respirators.

## 3M™ Reusable Respirators – Technology Innovations Over the Years:

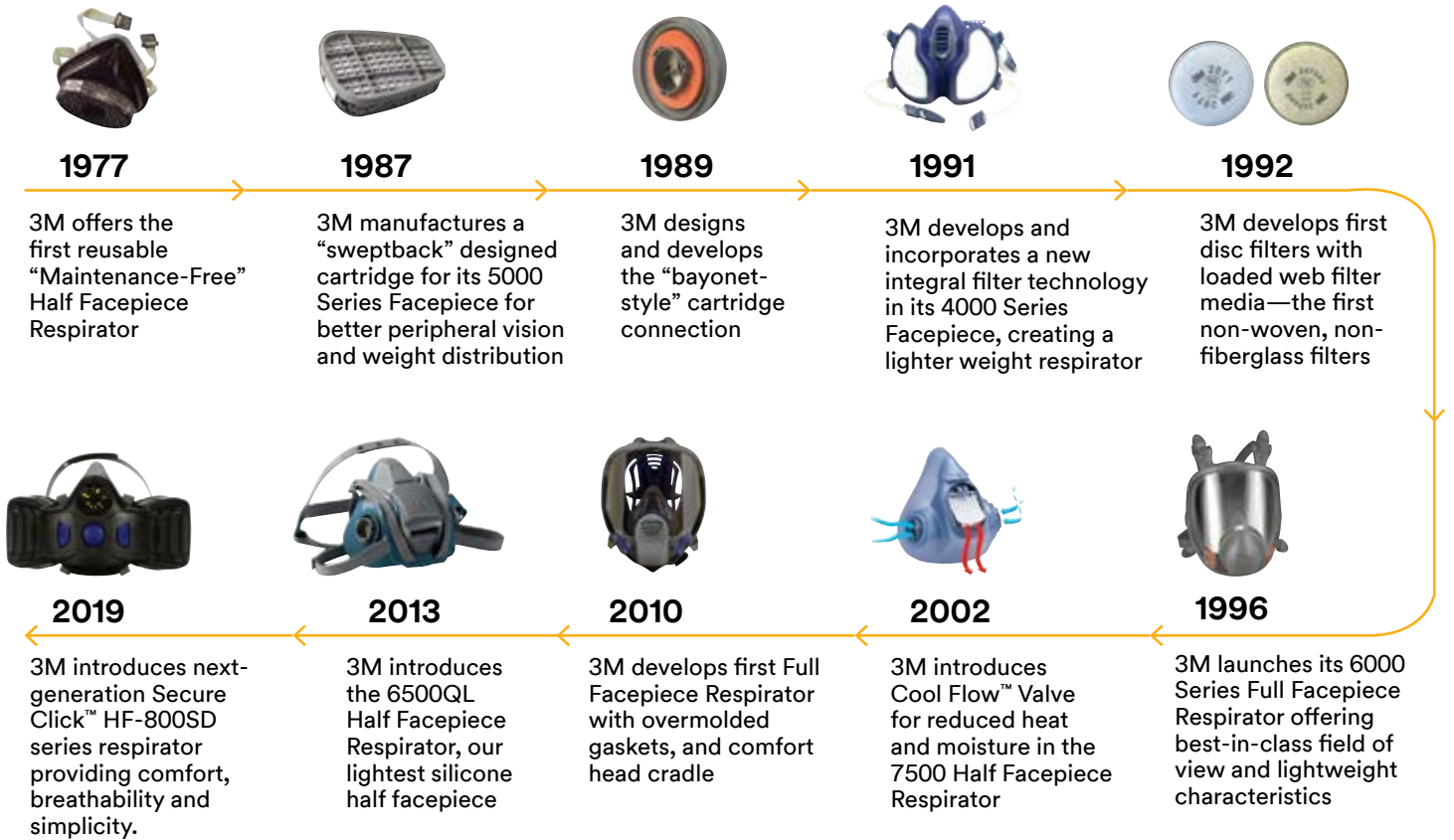

ID 1635211  
RID 1695021 & 1695024

# A respiratory solution for every task.

It's clearly recognised that we need clean air to survive and that exposure to toxins could cause irreparable damage to our health, but sometimes respiratory risks are not obvious or the damage to human respiratory systems occurs over a longer period of time, which is why choosing suitable respiratory protection is important for long term worker health.

AS/NZS 1715:2009 which covers the selection, use and maintenance of respiratory protection equipment states: "The effective management of risks to health is achieved by identifying the hazards, assessing the risk associated with those hazards and controlling the risks to health".

The following summarises the tasks needed to ensure a safe respiratory working environment.

1. Undertake a risk assessment to identify the hazard and if possible remove or reduce the hazard, which is always preferable to using Respiratory Protective Equipment (RPE). If this is not possible, appropriate RPE will need to be selected and implemented, to prevent inhalation of contaminated air.
2. A clearly defined set of selection steps must be followed to determine the type of RPE that is best suited for the job and the contaminant.

Respiratory protective devices are classified into two main groups; Air Purifying Respirators (Filtering devices) and Air Supplied Breathing Apparatus.

Where an Immediately Dangerous to Life and Health (IDLH) atmosphere is identified, air purifying respirators/filtering devices are not suitable, and self-contained and/or air supplied demand breathing apparatus must be used, due to the risk of oxygen displacing gases or other hazards where a filter may not provide appropriate protection from the hazard. RPE are given a Protection Factor (PF), which is a measure of the efficiency of the respiratory protection devices, i.e. if the content of a substance on the inside of the facepiece is one fiftieth of what it is in the ambient air, the respiratory protective device is said to have a Protection Factor of 50.

In addition to identifying the hazard, AS/NZS 1715:2009 states that;

- All users must be trained to use RPE
- RPE must fit properly to prevent leaks around the edges
- Fit-testing must be done before first wearing a tight fitting facepiece
- Beards, moustaches, sideburns, stubble & long hair are not allowed when wearing a tight fitting facepiece
- Cleaning and maintenance of RPE is required.



ID 2245774  
RID 2244163

# Selecting a Respirator for your Workplace

Respirator selection is one part of an effective respiratory protection program. After performing an exposure assessment and determining that respiratory protection is required, you're ready to select the appropriate protection for your employees.

## What are the respiratory hazards in your workplace?

You'll need to select equipment based on whether your work environment contains a particulate hazard, a gas or vapor hazard, or both types of hazards.



### Gases/Vapours

*E.g. certain organic vapours and gases such as chlorine, sulfur dioxide and ammonia.*

Common applications include chemical manufacturing/ handling, painting, coating and cleaning.



### Particulates

*E.g. dusts, mists, metal fumes and fibers.*  
Common applications include drilling, cutting, welding, grinding and sanding.





### Oxygen deficiency

*(<19.5% O2) E.g. confined spaces*  
Reusable respirators can be considered for a wide variety of workplace exposures but are not intended for use in oxygen deficient environments. If oxygen deficiency or other immediately dangerous to life or health (IDLH) conditions are of concern, please reach out to your local 3M Sales Representative.

## What level of protection do you need?

Assess exposure levels and applicable workplace exposure standards.

The required minimum protection factor (RMPF) is protection factor required to reduce exposure to an accepted level. It is expressed as a ratio of the measured ambient airborne concentration of a contaminant to an acceptable exposure level or standard. For instance, an RMPF of 10 means the respirator can protect against exposure levels that are up to 10 times the Workplace Exposure Standard (WES)/Workplace Exposure Limit (WEL) for that contaminant.

 <b>Half Facepiece Respirators</b>	 <b>Full Facepiece Respirators</b>	 <b>Positive Pressure Respirators</b>
RMPF 10	RMPF 50 or 100	RMPF 100+
Half facepiece respirators and full facepiece respirators that have been qualitatively fit tested, have an RMPF of 10.	Full Facepieces respirators, when quantitatively fit tested, have an RMPF of 50 or 100 depending on the type and class of filter.	If a RMPF of 100+ is needed positive pressure respiratory protection assemblies can be considered. For IDLH conditions, consider SCBA and/or supplied airline with emergency breathing device.

## What is the appropriate product selection?

Match the reusable respirator facepiece to the appropriate filter/cartridge.

**1** Choose your cartridge/filter type:  
e.g. particulate, organic vapour, organic vapour/particulate, etc.

**2** Choose your facepiece.  
Note that not all filter/cartridge types are available for all reusable respirators.

# Comprehensive respiratory protection



### 3M™ Particulate Filters

Filter particulates (e.g., dusts, mists, fumes, fibers, mould, bacteria, etc.). Some filters also have nuisance-level gas and vapour capabilities.



### 3M™ Gas & Vapour Cartridges

Protect against certain gases and vapours that can be found in the workplace. Multiple options are available for different airborne hazards.



### 3M™ Gas & Vapour Cartridges with Particulate Filters

Combine gas and vapor protection with a built-in particulate filter. As with gas and vapour cartridges, various cartridges are available for specific hazards in the workplace.



### 3M™ Reusable Respirators

3M offers a full line of reusable respirators with half or full facepiece options, compatible with a wide range of filters/cartridges.

### Need help finding the right solution for your application?

Our 3M™ Select and Service Life Software can help make it faster and easier to select the appropriate respirator and filter/cartridge.

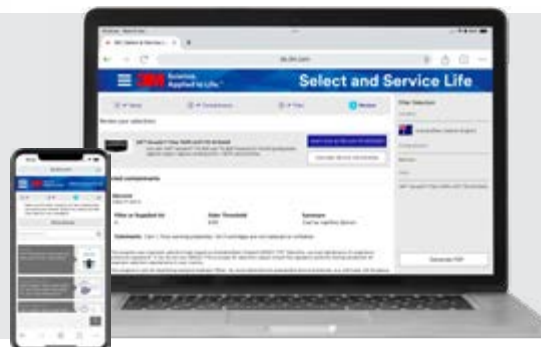

3M Select and Service Life (SLS) Software  
[sls.3m.com](https://sls.3m.com)

# What kind of 3M™ Reusable Respirators are there?



### Half facepiece respirators

- ▶ Seal around the nose and mouth.
- ▶ Provide negative pressure respiratory protection.
- ▶ Also compatible with powered and supplied air configurations\*



### Full facepiece respirators

- ▶ Seal around the outer edges of the face.
- ▶ Provide negative pressure respiratory protection and eye protection.
- ▶ Also compatible with powered and supplied air configurations\*

\*Depending upon respirator platform.

## Reusable Respirator platform options

- ▶ **3M™ Secure Click™** – helps provide confidence that cartridges and filters are installed properly
- ▶ **3M™ Bayonet** - widest range of facepiece, cartridge and filter options
- ▶ **3M™ DT-Series** - for heavy duty environments

# Why choose 3M™ Reusable Respirators?

## Versatile protection

With a wide range of facepieces, cartridges and filters offering an Assigned Protection Factor from 10-100, 3M reusable respirators can be used for numerous applications and hazardous environments. Some 3M facepieces can be used in powered or supplied air mode, allowing for an RMPF of 100+ when used with powered air purifying respirators (TR-600 or TR-800).

## Designed for comfort

Workers deserve to be comfortable and protected whether they are in a tight space or working a long shift. Select from a variety of comfort features like silicone for a softer feel on the face and 3M™ Cool Flow™ Valve for easy breathing.

## Simple and intuitive

Whether you need multi-use respiratory protection or a maintenance free offering, our solutions are easy to use.

## Respirator protection specialists

Our dedicated team is available to share their industry, product and regulatory knowledge to help you understand your available options to help keep workers protected.

# Select the right respirator.

Half and Full Facepiece Respirators; are offered in a variety of materials and sizes to suit most face sizes and shapes.



Half Facepieces	HF-800SD	6000	6500QL	7500	4000+
Platform Type	3M™ Secure Click™	3M™ Bayonet	3M™ Bayonet	3M™ Bayonet	Integrated
Drop-down Feature			✓	✓	
3M™ Cool Flow™ Valve			✓	✓	
Silicone Face Seal	✓		✓	✓	
Lightweight TPE Face Seal		✓			
Speaking Diaphragm	✓				
Seal Check Button	✓				
Compatible with Most Welding Shields	✓	✓	✓	✓	
Compatible with 3M™ Supplied Air System				✓	
Compatible with 3M™ PAPR Systems				✓	

Refer to catalogue sections for further information on each product and country availability.



Full Facepieces	FF-800	6000	FF-400	FF-300*	FF-600	FF-600F
Platform Type	3M™ Secure Click™	3M™ Bayonet	3M™ Bayonet	3M™ DT-Series	3M™ DT-Series	3M™ DT-Series
3M™ Cool Flow™ Valve	✓	✓	✓			
Silicone Face Seal	✓	✓	✓		✓	✓
Speaking Diaphragm	✓		✓	✓	✓	✓
Seal Check Button	✓					
Compatible with 3M™ Supplied Air System		✓		✓	✓	
Compatible with 3M™ PAPR Systems		✓	✓	✓	✓	

Refer to catalogue sections for further information on each product and country availability.

\* FF-300 is an Export controlled product. Document required to be signed upon purchase.

# Reusable Respirator Filter & Cartridge Ratings

Filter Type	Colour	Main area of application
P	White	Particles: Dusts, mists, fumes, fibres, toxic particles & microorganisms (bacteria, fungi, viruses, enzymes)
A	Brown	Organic vapours with boiling point >65°C. eg. Toluene, Xylene, MEK, Benzene, Alcohols
AX	Brown	Highly volatile organic solvents with boiling point <65°C. e.g. Methanol, 1,3-Butadiene, Acetaldehyde
B	Grey	Acid gases, e.g chlorine, hydrogen sulphide, hydrogen chloride
E	Yellow	Inorganic gases such as sulphur dioxide
K	Green	Ammonia and organic ammonia derivatives
Hg	Red	Mercury (vapour)
G		For use against certain organic compounds with vapour pressure less than 1.3 Pa (0.01 mm Hg) at 25°C.
Nuisance Gas/Vapour		For use against certain gas/vapour contaminants where exposure levels are underneath the relevant Workplace Exposure standard (WES)/Workplace Exposure Limit (WEL)

Application limits for Gas & Vapour respirators (AS/NZS 1715:2009).

- Half facepiece respirators can be used up to 10 times the relevant Workplace Exposure Standards (WES) or up to 1000 ppm, whichever limit is reached first.
- Full facepiece respirators can be used up to 50 times the WES with a Class 1 filter or up to 1000 ppm, whichever limit is reached first.
- A1 and A2 Cartridges are designed for use with organic vapours with a boiling point above 65°C.
- AX Cartridges are used for organic vapours with a boiling point under 65°C. Note: 3M™ AX Cartridges are single use and can only be fitted to 3M™ Full facepiece respirators.

This selection guide is only an outline designed to focus on products which may be appropriate for typical applications - it should not be used as the only means of selecting a product. Selection of the most appropriate personal protective equipment (PPE) will depend on the particular situation and exposure levels and should be made only by a competent person knowledgeable of the assessed risks, actual working conditions and limitation of PPE. Details regarding performance and limitations are set out on the product packaging and user information. If in doubt, contact a health and safety professional or 3M.

## Hazard identification and filter recommendations.

Industry	Application	Hazard	Filter Recommendation
Construction	Painting, spraying, varnishing, coating	Solvent-based paint Solvents, resins, synthetic resins Latex-paint, residual solvents Spray-on glue, foam, varnish, adhesive	A1P2
Metal Fabrication	Welding, metal cutting, metal pouring, soldering, brazing	Metal fumes	P2
	Welding - TIG, MIG and other	Metal fumes, ozone gas. Nuisance levels of organic vapour	GP2
Agriculture	Spraying low vapour pressure*** pesticides, herbicides or fungicides	Nuisance Level Organic vapours, mist, dust	GP2
	Mixing pesticide, herbicide or fungicide or spraying organic vapours	Organic vapour, mist, dust	A1P2
Automotive	Cleaning or using organic solvents, degreasing, paint thinners and glues	Organic vapour	A1
	Brush or roller application* of 2 pack type paints	Isocyanates*	A1
Fibreglass	Laying up	Expoxy and polyester resin, amines & anhydride hardner Methy ethyl ketone peroxide (MEKP), styrene vapour	A1P2
	Using a chopper gun	Glass fibre, dust, resin and styrene vapour	A1P2
	Spray painting & cleaning moulds	Organic vapour and mist	A1P2
Maintenance	Disinfection, cleaning	Organic vapour, mist and dust	A1P2
		Organic vapour, formaldehyde, mist and dust	AFormP2
Other	Handling	Ammonia (NH3)**	K
		Bacteria, spores, odours	P2
		Hydrochloric acid vapour or mist**	ABEP2
		Petroleum solvents	A2
		Sulphur dioxide**	E
		Particulates**	P2
		Hazardous goods storage/transport	Seek specialised advice from 3M

\* For protection from Isocyanates when spraying polyurethanes/2 pack, please contact your local 3M representative. \*\*Also need to consider eye/face/skin protection. \*\*\*Low vapour pressure < 1.3Pa @ 25°C.

# 3M™ Select and Service Life Software



QR-CAT-SLS

Scan or Click to go to the 3M Select and Service Life Software

## When should I change my Gas & Vapour cartridges

Once you know what's in your air, 3M™ Select and Service Life Software helps you explore respirators, cartridges and filter options and select the one that's right for you. Then you can establish an effective gas/vapour cartridge change out schedule to help keep workers protected.

- Suitable for 3M™ Secure Click™ and 3M™ Bayonet reusable respirator filter. Service Life Software Does not include 3M™ DT Series cartridges.
- Suitable for 3M Versaflo PAPR TR-600 & TR-800 cartridges. Does not include Adflo cartridges.

Get started at [www.3m.com/sls](http://www.3m.com/sls)

## The software is comprised of two sections:



### Respirator Selection

The Respirator Selection is designed to help you choose the appropriate 3M Respirator and Cartridge for your selected contaminant.



### Service Life Calculation

The Service Life Calculation is designed to help you estimate the service life of selected 3M Gas and Vapour Cartridges.

## What information do I need to know to use this software?

To get the most out of the 3M™ Select and Service Life Software, you will need the following information.

## What chemical contaminants am I using and what is the exposure level?

For contaminant information check the SDS which will list the ingredients and the unique chemical ID numbers (CAS Number).

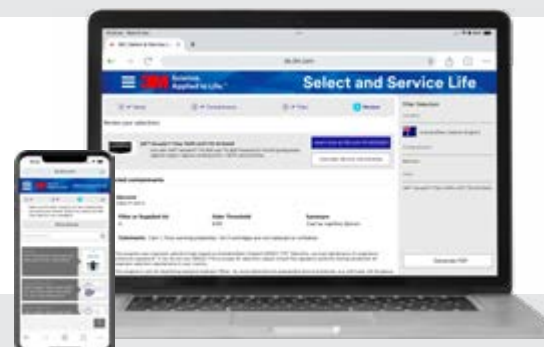

## Service Life Calculation

Knowing the specific contaminants and exposures is required to estimate the life of selected 3M™ Gas and Vapour Cartridges.

- A. What 3M gas/vapour cartridge am I using e.g. reusable or PAPR?
- 
- B. How humid is the environment?  
<65% 65% 75% 85% 90% (% Relative Humidity)
- C. Atmospheric pressure: This will default to 1ATM. Adjust if you are below sea level (range 0.8 - 1.2 ATM)
- D. What temperature is the environment?  
10°C 20°C 30°C 40°C 50°C
- E. How strenuous will the work be or what flow rate is the PAPR on? For TR-600 & TR-800, is it a loose fitting headtop or a tight fitting facepiece and what flow setting?
- Light (e.g. sitting or standing to control machines, performing light hand or arm work)
- Medium (e.g. walking about with moderate lifting and pushing)
- High (e.g. pick and shovel work)

Using the above information, you will be able generate a report providing an estimate of how long the selected 3M Gas & Vapour Cartridge will last until the selected contaminants fill up the cartridge and estimated break through occurs.



QR-RR-01

Scan or Click to watch a video on how to use the software

The service life estimates in this software apply only to specified 3M respirators and cartridges, and must not be used for non-3M respirators and cartridges.

The values generated by the software are estimates only. For example, the math model used to estimate organic vapour service life at <65% RH may have uncertainty of ± 50%.

Estimated service life depends on the specific work environment. Accurate input data from the user is essential. Appropriate safety factors should be used to account for any sources of uncertainty

This service life software is not for particle filters.

## Require assistance?

Contact Customer Service: Australia  
1300 363 565 or New Zealand 0800 252 627

Contact your 3M Sales Person or go to the Help section of the software

# Select the right respirator and filter/cartridge.

## Secure Click Filters & Cartridges

**HF-800SD Series**

**FF-800 Series**

**Particulate Protection**

D3125 P2    D3135 P3\*\*    D9035 P3\*\*

**Particulate Protection + Nuisance Level\* Organic Vapour and Acid Gas**

D3128 P2    D3138 P3\*\*    D9038 P3\*\*

**Gas & Vapour Protection Only**

D8051 A1    D8055 A2    D8057 A1B1E1 + Form    D8059 A1B1E1K1 + Form

**Combined Particulate + Gas & Vapour Protection**

D8051 A1  
D8055 A2  
D8057 A1B1E1 + Form  
D8059 A1B1E1K1 + Form

D7925 P2    OR    D7935 P3\*\*    D701

D8094 A1B1E1K1 + Form P3\*\*    D8095 A2P3\*\*    D8097 A1B1E1K1HgP3 + Form

\* Nuisance Levels are those levels below the Workplace Exposure Standard (WES)/Workplace Exposure Limits (WEL)

\*\* Provides P3 protection only with 3M Full Facepiece Respirators. Provides P2 protection with half facepiece respirators

Refer to catalogue sections for further information on each product and country availability



ID 1635200  
RID 1695023

# Reusable Respirators

## 3M Bayonet Filters & Cartridges

**6000 Series**

**6500QL Series**

**7500 Series**

**6000 FF Series**

**FF-400 Series**

**Particulate Protection**

6035 P2/P3\*\* 2125 P2 2135 P2/P3\*\*  
603 5925 P2 5935 P3\*\* 501

**Particulate Protection + Nuisance Level\* Organic Vapour and Acid Gas**

6038 P2/P3\*\* 2128 GP2 2138 GP2/GP3\*\*

**Gas & Vapour Protection only**

6051 A1 6057 ABE1  
6055 A2 6059 ABEK1  
6054 K1 6075 A1+Form

**Combined Particulate + Gas & Vapour Protection**

6051 A1 6057 ABE1 5925 P2 501  
6055 A2 6059 ABEK1 5935 P3\*\*  
6054 K1 6075 A1+Form

6096 A1E1HgP3\*\*  
6098 AXP3\*\*  
6099 A2B2E2K2P3\*\*  
60926 A1B1E1K1 FormHF/P3\*\*  
6098 and 6099 are only for use with Full facepiece.

6051 A1 6057 ABE1 502 Adapter 2125 P2, 2128 GP2, 2135 P2/P3\*\*, 2138 GP2/GP3\*\*  
6055 A2 6059 ABEK1 6035 P2/P3\*\*  
6054 K1 6075 A1+Form 6038 P2/P3\*\*

Refer to catalogue sections for further information on each product and country availability.

**4000+ Series**

**Combined Particulate + Gas & Vapour Protection**

4251+ A1P2  
4255+ A2P2  
4277+ A1B1E1P2  
4279+ A1B1E1K1P2

**Ready to use, Maintenance free**

\* Nuisance Levels are those levels below the Workplace Exposure Standard (WES)

\*\* Provides P3 protection only with 3M Full facepiece Respirators. Provides P2 protection with half facepiece respirators.



# Reusable Respirators

## DT-Series Filters and Cartridges



**FF-300 Series**  
Export controlled product. Document required to be signed upon purchase.



**FF-600F Series**



**FF-600 Series**

**Particulate Protection**



DT-1135E P3

**Gas & Vapour Protection Only**



DT-4001E A2

**Pre-Filters and Accessories**



SS-6601



SS-6600



SS-6607



SS-6603

Refer to catalogue sections for further information on each product and country availability.

**Combined Particulate + Gas & Vapour Protection**



DT-4031E A2P3



DT-4035E A2B2E1P3



DT-4036E A2B2E1P3



DT-4045E A2B2E2K2-P3



DT-4046E A2B2E2K2HgP3



DT-4047E AXP3

\* Nuisance Levels are those levels below the Workplace Exposure Standard (WES)/Workplace Exposure Limits (WEL)



ID 2013347  
RID 2013659

# How do particle filters work?

A bed of randomly oriented fibres is used to create the filter. Treated fibres can be used to attract and trap particles as they flow into and through the filter material. Increasing the thickness and capture effectiveness of the filter material increases the filter efficiency at capturing particles. Particle filters are tested according to AS/NZS 1716:2012 Section 4.3.5 and Appendix I and L. The physics of particle capture indicates that the particle size range 0.02-0.2 micron equivalent diameter and a mass median particle diameter of approximately 0.3 to 0.6  $\mu\text{m}$  is the most difficult size range to capture. The filter is tested with a sodium chloride challenge aerosol consisting of particles mainly of this size. There are four common mechanisms of filtration being interception capture, inertial impaction, diffusion capture and electrostatic attraction. In practice, particle filters designed for respiratory protection will capture particles of all sizes – the major difference is the relative performance in the range between ~0.1 and 1  $\mu\text{m}$ . Each class of filter must perform above a certain level against the test aerosol to be then classified under AS/NZS 1716:2012 as explained below.

## What's a P1, P2, P3 rating filter?

A P1 is an AS/NZS 1716:2012 rated particle filter for use with Mechanically generated particles e.g. particles generated by crushing, grinding, drilling, sanding, cutting, etc including silica, wood dust, mists from spraying.

A P2 is an AS/NZS 1716:2012 rated particle filter for use with Mechanically and Thermally generated particles eg welding fume. These are also the recommended type for use with airborne particles that may contain biological hazards.

A P3 filter is the highest efficiency particle filter class and is used for particulates that are of high toxicity or at high concentrations. The benefit of this high efficiency filter can only be achieved on a full facepiece respirator system.

## Why do I need to replace my 3M Particulate Filters regularly?

As filters load up with captured particles, they actually become more efficient at filtering. However, they also become harder to breathe through. At some point, the filter will become too clogged for comfort and needs to be changed. How soon this occurs depends on the amount of particles in the air, and to an extent on individual preference – some people are more sensitive to an increase in breathing resistance than others. Filters must also be replaced whenever they are damaged in any way, such as by welding sparks.

## When should I replace my 3M Particulate Filters?

Remember the “3 Ds”, and replace your filter whenever it becomes:

- Damaged
- Dirty
- Difficult to breathe through

## Are there situations where particle filters must not be used?

There are several applications where particle filters should NOT be used:

- When the ambient Oxygen level is not guaranteed to be > 19.5%. Filters do not create oxygen.
- For the capture of gases or vapours - these need a specifically rated gas/vapour filter.
- When the airborne particulate contaminant concentrations are high i.e. greater than the standard allows for that respirator type.
- When Government Regulations require use of airline or other specific type of respirator for specific applications.

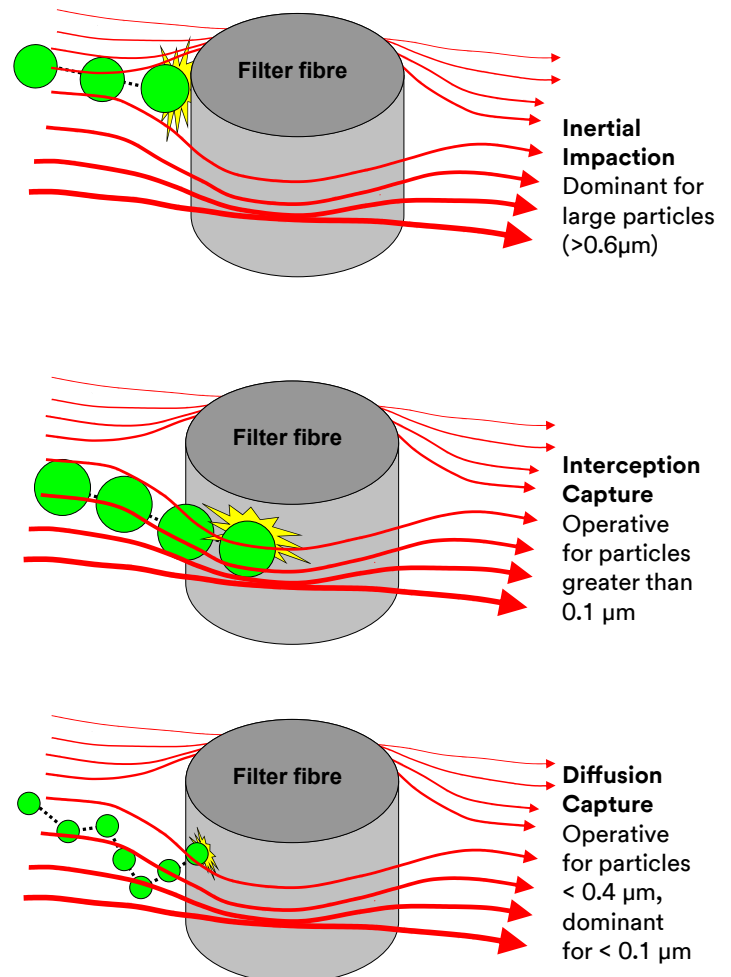

Click or scan to download the  
3M ANZ The Importance of  
Filter change whitepaper



QR-CAT-WP1

# How do 3M™ Cartridges work?

3M cartridges use activated carbon to filter gas and vapour contaminants from the air while allowing the filtered air to pass through. Certain types of contaminants, like certain organic vapour, adhere to the surface of the activated carbon and are captured. Other contaminant gases require specific treatments to the activated carbon to chemically bond and trap the contaminant molecules within the carbon. The differing types of carbon treatments is why unique cartridges are required for use against specific contaminants.

## Why do I need to replace my 3M Cartridge regularly?

When the carbon inside the cartridge is “full” of the contaminant gases or vapour, they start to pass through the cartridge to the user. This is called “breakthrough.” Cartridges need to be replaced prior to breakthrough to avoid exposing the respirator wearer to contaminants. There are multiple factors affecting the useful life of a cartridge, known as “service life”. The best way to determine service life of a 3M cartridge, and a replacement schedule for cartridges, is to use the 3M Service Life Software, [3M.com/sls](https://www.3m.com/sls).

## When should I replace my 3M Cartridges?

- In accordance with your established change schedule, government regulation, or earlier if contaminants can be detected inside the respirator by smell, taste or irritation.
- If the cartridge is damaged in any way it should be discarded and replaced.
- If the cartridge has an attached particulate filter, replace the cartridge/ filter when it becomes damaged or soiled, or if breathing becomes difficult.
- If the cartridge and attached particulate filter is used in environments containing oil aerosols, replace the cartridge/filter after 40 hours of use or 30 days, whichever is first.

## How can I avoid using my 3M Cartridge beyond its service life?

- To help establish how frequently your cartridges should be replaced, visit 3M Service Life Software at [3M.com/sls](https://www.3m.com/sls).
- Before use, check the expiration date printed on the cartridge package. Most reusable respirator cartridges have a shelf life of 5 years.
- When you first remove a cartridge from the package, write the date on the cartridge itself.
- Perform air monitoring to determine average concentrations of certain contaminants over a measured time interval.

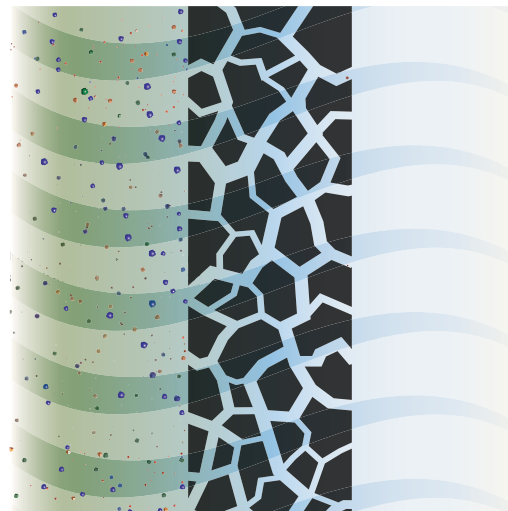

Unfiltered organic vapours are drawn into the cartridge.

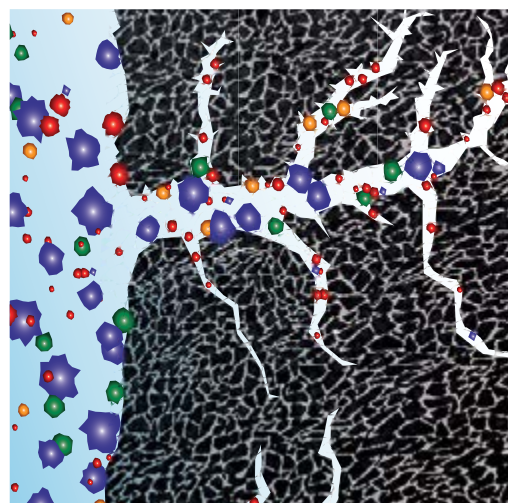

Activated carbon absorbs organic vapours on molecular level.

## Factors affecting cartridge service life:

- Type of contaminant
- Exposure concentration
- Breathing rate
- Temperature
- Humidity (water vapour takes up space in carbon filter pores)



QR-CAT-SLS

For assistance in determining 3M™ Secure Click™ and 3M Bayonet gas/vapour cartridge breakthrough and filter change schedules for certain gas/vapour contaminants visit

**3M Select and Service Life (SLS) Software** | [www.3m.com/sls](https://www.3m.com/sls)



## Confidence in a click

3M™ Secure Click™ Reusable Respirators are 3M's next generation of reusable respiratory protection. Invented, not imitated, 3M Secure Click respirators offer many innovative features that are designed to meet the demands of today's workforce. When used with approved 3M™ Secure Click™ Cartridges and Filters, they help protect against particulates and/or a wide variety of gases and vapours. Both half and full facepiece options are intuitive, comfortable and reliable. Available in 3 sizes to help fit a wide range of faces.



### Hear it:

Secure Click connection helps provide confidence that filters/cartridges are installed properly. Simply align the connections and push until you hear a click.



### Check it:

Easy, one-touch seal check helps increase worker confidence that the respirator is being worn properly.



### Say it:

Speaking diaphragm is designed to provide easy communication.



### Feel it:

Experience the breathability and comfort provided by the world's first quad-flow cartridge system.

## 3M™ Secure Click™ Half Facepiece Reusable Respirator, HF-800SD Series

Designed with smart and intuitive features, the 3M™ Secure Click Half Facepiece Reusable Respirator HF-800SD Series helps protect workers from particulates and a wide variety of gases and vapours when used with approved 3M™ Secure Click™ filters and cartridges.

- Complies with AS/NZS 1716:2012 Respiratory Protective Devices

### Features and Benefits:

**For use with the range of 3M Secure Click Filters & Cartridges**

**Say It:**

- Speaking Diaphragm designed to help provide easy communication

**Hear It:**

- Quick, simple cartridge/filter connection. Simply align the connections and push until you hear click
- Confidence that filters and cartridges are installed properly provided by unique Secure Click™ Cartridge/Filter connection

**Silicone Flex-Joint Face Seal**

- Provides a softer feel for more comfort on the wearer's face
- Face seal designed to sit lower on the nose bridge to help improve eyewear compatibility

**Easy-Adjust Buckle**

- Simple two-way adjustability: pull straps to tighten, squeeze wings to loosen

**Feel It:**

- Dual-flow cartridge design allows for air to be pulled through both sides of the cartridge for easy breathing

**Check It:**

- Easily conduct required seal check prior to each use
- The quick, easy, one-touch negative pressure push button seal check provides improved confidence in respirator fit

**Exhalation Valve**

- Helps direct exhaled breath and moisture downward

**Compatibility**

- Low profile design offers a wide field of view and compatibility with certain welding and grinding shields

QR-RR-02

Scan or Click for Tech Data Sheet

QR-RR-03

Scan or Click for Fitting Poster

QR-RR-04

Scan or Click for Training Videos

SAP ID	Legacy ID	Availability		Model #	Description
		AUS	NZ		
7100172006	UU009621507 (AUS) NT070013015 (NZ)	•	•	HF-801SD	3M™ Secure Click™ Half Facepiece Reusable Respirator with Speaking Diaphragm HF-801SD, Small, 1 ea/Box
7100171980	UU009622216	•	•	HF-802SD	3M™ Secure Click™ Half Facepiece Reusable Respirator with Speaking Diaphragm HF-802SD, Medium, 10 EA/Case
7100172005	UU009620970	•	•	HF-803SD	3M™ Secure Click™ Half Facepiece Reusable Respirator with Speaking Diaphragm HF-803SD, Large, 10 EA/Case
7000001938	AT010587411 (AUS) 70070317139 (NZ)	•	•	504	3M™ Respirator Cleaning Wipe 504, 100 Each/Pack, 500 Each/Case

For spare parts and accessories refer to the Part & Accessories pages

# 3M™ Secure Click™ Full Facepiece Reusable Respirator, FF-800 Series

Designed with smart and intuitive features, the 3M™ Full Facepiece Reusable Respirator FF-800 Series helps protect workers from particulates and a wide variety of gases and vapours when used with approved 3M™ Secure Click filters and cartridges.

## Features and Benefits:

**Say It:**

- Speaking Diaphragm designed to help provide easy communication

**Hear It:**

- Quick, simple cartridge/filter connection. Simply align the connections and push until you hear click
- Confidence that filters and cartridges are installed properly provided by unique Secure Click™ Cartridge/Filter connection

**Check It:**

- Easily conduct required seal check prior to each use
- The quick, easy, one-touch negative pressure push button seal check provides improved confidence in respirator fit

**Feel It:**

- Dual-flow cartridge design allows for air to be pulled through both sides of the cartridge for easy breathing

**Durable, Long-Lasting Head Harness**

- Features a six-strap configuration for a secure fit

**Large Lens**

- Meets AS/NZS 1337:1:2010 standard for eye and face protection
- Scratch resistant

**Comfort Cradle**

- Positions respirator more comfortably on head, reducing pressure points and hair pulling
- Helps make respirator donning easier

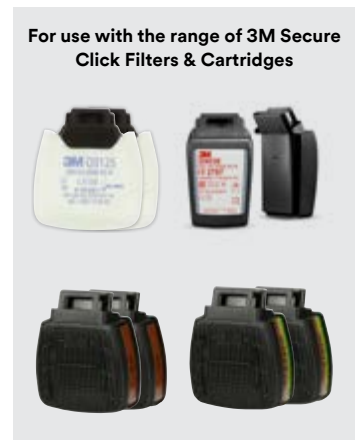

Complies with AS/NZS 1716:2012 Respiratory Protective Devices

QR-RR-05

Scan or Click for Tech Data Sheet

QR-RR-06

Scan or Click for Fitting Poster

QR-RR-07

Scan or Click for Training Videos

**Soft, Silicone Nose Cup and Faceal**

- For added user comfort

**Exhalation Valve Cover**

- Helps direct exhaled breath and moisture downward.

SAP ID	Legacy ID	Availability		Model #	Description
		AUS	NZ		
7100262627	70071766193	•	•	FF-801	3M™ Secure Click™ Full Facepiece Reusable Respirator FF-801, Small, 4 ea/Case
7100262628	70071766201	•	•	FF-802	3M™ Secure Click™ Full Facepiece Reusable Respirator FF-802, Medium, 4 ea/Case
7100262626	70071766219	•	•	FF-803	3M™ Secure Click™ Full Facepiece Reusable Respirator FF-803, Large, 4 ea/Case
7000029958	70071516978	•	•	FF-400-15	3M™ Lens Cover FF-400-15, 100 ea/Bag
7100254233	XA006514674	•	•	102	3M™ Universal Spectacle Kit 102, 1 ea/Case
7000001938	AT010587411 (AUS) 70070317139 (NZ)	•	•	504	3M™ Respirator Cleaning Wipe 504, 100 Each/Pack, 500 Each/Case

For spare parts and accessories refer to the Part & Accessories pages

# Reusable Respirators 3M™ Secure Click™

## 3M™ Secure Click™ Gas & Vapour Cartridges



**Compatible facepieces for Secure Click Filters and Cartridges**



QR-RR-08  
Scan or Click for Tech Data Sheet



QR-CAT-SLS

For assistance in determining 3M Secure Click gas/vapour cartridge breakthrough and filter change schedules for certain gas/vapour contaminants visit the free **3M Select and Service Life (SLS) Software** | [www.3m.com/sls](http://www.3m.com/sls)

SAP ID	Legacy ID	Availability		Model #	Description
		AUS	NZ		
7100153224	UU009286772	•	•	D8051	3M™ Secure Click™ A1 Filter, D8051, 64/case
7100153231	UU009288695	•	•	D8055	3M™ Secure Click™ A2 Filter, D8055, 64/case
7100306964	UU012645204	•	•	D8057	3M™ Secure Click™ A1B1E1 + Form Filter, D8057
7100153226	UU009288406	•	•	D8059	3M™ Secure Click™ Cartridge D8059, A1B1E1K1 + Form, with Dual Flow, 4 Pairs/Box, 8 Boxes/Case
7100153236	UU009289347	•	•	D8094	3M™ Secure Click™ Cartridge D8094, A1B1E1K1 + Form P3, with Dual Flow, 4 Pairs/Box, 8 Boxes/Case
7100153235	UU009289339	•	•	D8095	3M™ Secure Click™ Cartridge D8095, A2P3R, with Dual Flow, 4 Pairs/Box, 8 Boxes/Case
7100300208	UU012455943	•	•	D8097	3M™ Secure Click™ Filter A1B1E1K1Hg + Form P3, with Dual Flow, D8097

## 3M™ Secure Click™ Particulate Filters



QR-RR-09  
Scan or Click for Tech Data Sheet

SAP ID	Legacy ID	Availability		Model #	Description
		AUS	NZ		
7100197481	70071731221	•	•	D3125	3M™ Secure Click™ Particulate Filter D3125, P2, 80 EA/Case
7100197480	70071731247	•	•	D3128	3M™ Secure Click™ Particulate Filter P2 D3128, with Nuisance Level* Organic Vapour/Acid Gas Relief, and Ozone up to 10 x OEL) 10 Pairs/Box
7100197284	70071731262	•	•	D3135	3M™ Secure Click™ Particulate Filter D3135, P2/P3**, 80 EA/Case
7100197270	70071731288	•	•	D3138	3M™ Secure Click™ Particulate Filter D3138, P2/P3**, with Nuisance Level* Organic Vapour/Acid Gas Relief and Ozone, 80 EA/Case
7100197286	70071731312	•	•	D7925	3M™ Secure Click™ Particulate Filter P2, D7925, 320 EA/Case. Requires D701 to connect to D8051, D8055, D8057 or D8059
7100197285	70071731320	•	•	D7935	3M™ Secure Click™ Particulate Filter P2/P3**, D7935, 320 EA/Case. Requires D701 to connect to D8051, D8055, D8057 or D8059
7100184498	UU010049979	•	•	D701	3M™ Secure Click™ Filter Retainer D701, 100 EA/Case. Required to connect D7925/7935 to D8051, D8055, D8057 or D8059
7100206891	UU010285664	•	•	D9035	3M™ Secure Click™ Hard Case Particulate Filter P2/P3**, D9035, 40 Packs/Case
7100206892	UU010291761	•	•	D9038	3M™ Secure Click™ Hard Case Particulate Filter P2/P3**, D9038, with Nuisance Level* Organic Vapour/Acid Gas Relief, 40 Packs/Case
7100213424	70071731361	•	•	D3076HF	3M™ Secure Click™ Particulate Cartridge P95/Hydrogen Fluoride w/ Nuisance Acid Gas Relief D3076HF, 100 ea/Case

## Particulate Filter and Gas/Vapour Cartridge Combination Assembly



\* Nuisance Levels are those levels below the Workplace Exposure Standard (WES). \*\*Provides P3 protection only with 3M Full Face Respirators. Provides P2 protection with half face piece respirators.

# Parts & Accessories 3M™ Secure Click™

## 3M™ Half Face Respirator Accessories HF-800SD

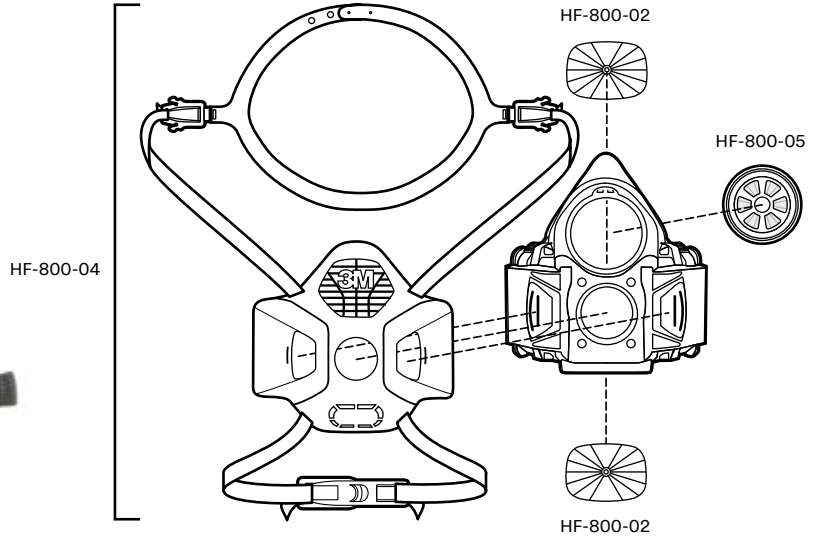

SAP ID	Legacy ID	Availability		Model #	Description
		AUS	NZ		
7100181933	UU009608314	•	•	HF-800-02	3M™ Secure Click™ Inhale & Exhale Valve, HF-800-02, 10 EA/Bag
7100181558	UU009620905	•	•	HF-800-03	3M™ Secure Click™ Quantitative Fit Test Adapter Kit HF-800-03, 1 EA/Case
7100181728	UU009607902	•	•	HF-800-04	3M™ Secure Click™ Head Harness Assembly for HF-800 Series Respirators with Speaking Diaphragm, HF-800-04, 5 ea/Case
7100181934	UU009620988	•	•	HF-800-05	3M™ Secure Click™ Speaking Diaphragm Assembly, HF-800-05, 5 EA/Bag



ID 2245810

Please note not all parts and accessories are stocked or active in our system. Please contact 3M sales rep or customers service for further clarification.

# Parts & Accessories 3M™ Secure Click™

## 3M™ Full Face Respirator Accessories FF-800

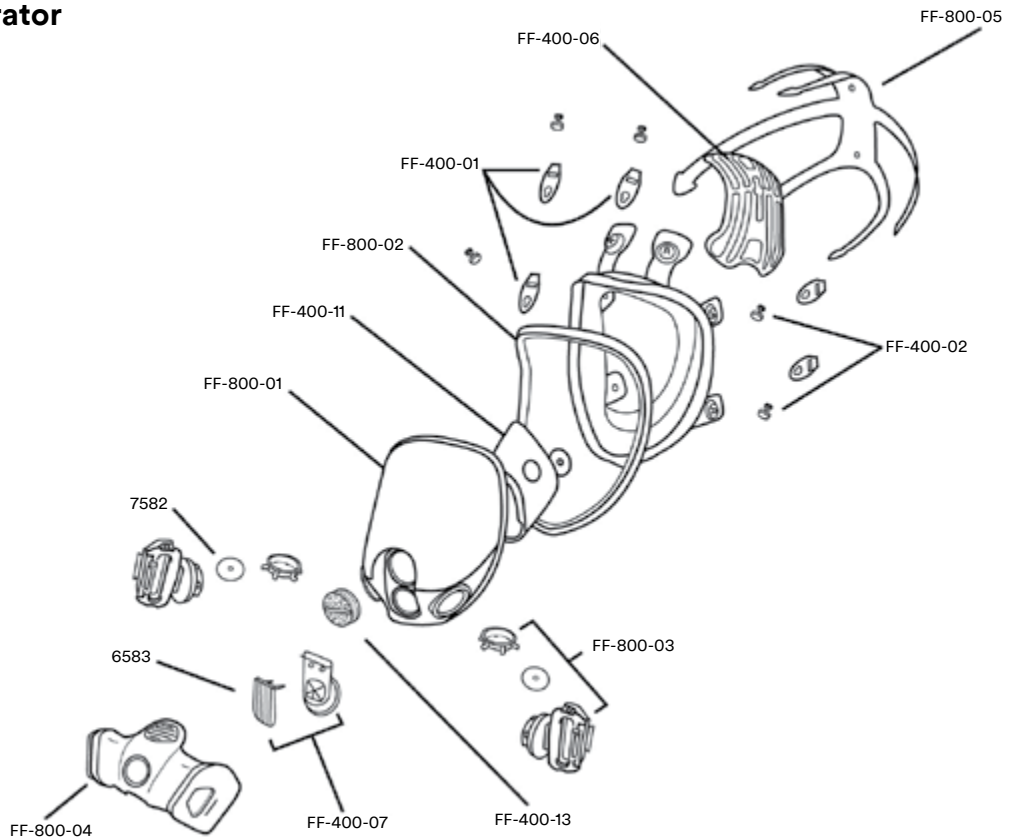

SAP ID	Legacy ID	Availability		Model #	Description
		AUS	NZ		
7100263777	70071765591	•	•	FF-800-01	3M™ Secure Click™ Lens Replacement FF-800-01, 5 ea/Case
7100266242	70071765609	•	•	FF-800-02	3M™ Secure Click™ Lens Frame Assembly FF-800-02, 5 ea/Case
7100265540	70071765617	•	•	FF-800-03	3M™ Secure Click™ Inhalation Valve Assembly FF-800-03, 10 ea/Case
7100267864	70071765716	•	•	FF-800-04	3M™ Secure Click™ Exhalation Valve Cover Assembly FF-800-04, 5 ea/Case
7100283489	70071766730	•	•	FF-800-05	3M™ Head Harness FF-800-05, 5 ea/Case
7100265593	70071765724	•	•	FF-800-06	3M™ Secure Click™ Quantitative Fit Test Adapter Kit FF-800-06, 1 ea/Case. QNFT-CNC
7000052734	70071516846	•	•	FF-400-01	3M™ Buckle FF-400-01, 30 EA/Case
7000052735	70071516853	•	•	FF-400-02	3M™ Button FF-400-02, 30 EA/Case
7000052737	70071516895	•	•	FF-400-06	3M™ Comfort Cradle Head Harness Attachment FF-400-06, 5 EA/Case
7000052738	70071516903	•	•	FF-400-07	3M™ Exhalation Valve Assembly FF-400-07, 5 EA/Case
7000052741	70071516945	•	•	FF-400-11	3M™ Nose Cup Assembly FF-400-11, 5 ea/Case
7000052742	70071516960	•	•	FF-400-13	3M™ Speaking Diaphragm Assembly FF-400-13, 5 EA/Case
7000029958	70071516978	•	•	FF-400-15	3M™ FF-400-15 Lens Cover 100/Bag
7100018862	70071668183	•	•	6583	3M™ Rugged Comfort Exhalation Valve 6583, 10/Case
7000002158	AT010561507	•	•	7582	3M™ Inhalation Valve 7582, Replacement Part 10 EA/Bag
7100254233	XA006514674	•	•	102	3M™ Universal Spectacle Kit 102, 1 ea/Case

Please note not all parts and accessories are stocked or active in our system. Please contact 3M sales rep or customers service for further clarification.

# Bayonet Connection: Designed for versatility and compatibility

A number of 3M™ Half and Full Facepiece Reusable Respirators feature the 3M™ Bayonet Connection System, which enables connection to a broad range of cartridges and filters to protect against gases, vapours, and particulates depending on individual needs. In addition, many of these respirators include a 3M™ Cool Flow™ Valve.

Additional features and benefits are facepiece series specific.



## 3M™ Cool Flow™ Valve

Hot, humid exhaled breath can cause discomfort when it builds up inside the facepiece. 3M™ Cool Flow™ Valve allows for:

- Easy breathing
- Release of warm, moist exhaled breath from inside the respirator
- Exhaled air directed downward

## 3M™ Half Facepiece Reusable Respirator, 7500 Series

The 3M™ Half Face Reusable Respirator 7500 Series has a soft, silicone face seal for greater comfort and durability. The 3M™ Cool Flow™ Valve helps make breathing easier and can reduce heat and moisture build-up for cool, dry comfort. Combine with a broad range of twin, lightweight 3M filters or cartridges to provide respiratory protection against particulates and a variety of gases and vapours.

- Compatible with TR-600 & TR-800 Versaflo PAPR with BT-63 or BT-64 breathing tubes
- Compatible with Dual Airline Stethoscope Airline Systems 902-03-15
- Complies with AS/NZS 1716:2012 Respiratory Protective Devices

### Features and Benefits:

#### Soft Faceseal Design

- Silicone material provides a soft feel on the face

#### 3M™ Cool Flow™ Valve

- Helps release warm and moist exhaled breath from inside the respirator
- Allows for easy breathing

#### Unique Exhalation Valve Cover

- Directs exhaled breath and moisture downward
- Smooth surface allows for quick and easy cleaning

7502 Medium

### Compatible with:



Refer to Powered Air Purifying Respirator and Continuous Flow Airline Sections for more information

#### Adjustable Head Cradle

- Allows wearer to adjust for optimum fit and comfort

#### Dual-mode Head Harness

- Adjusts easily so user has the option of wearing respirator in either traditional or drop-down mode

QR-RR-10  
Scan or Click for Tech Data Sheet

QR-RR-11  
Scan or Click for Fitting Poster

QR-RR-12  
Scan or Click for Training Videos

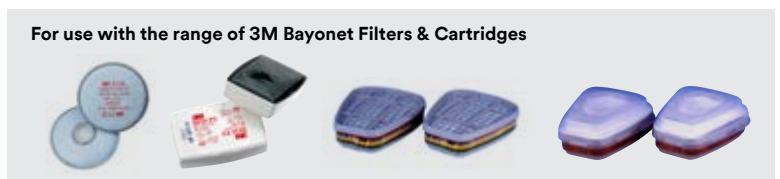

SAP ID	Legacy ID	Availability		Model #	Description
		AUS	NZ		
7000104176	XA007709323	•	•	7501	3M™ Half Facepiece Reusable Respirator 7501, Small, 10 Each/Case
7000104177	XA007709331	•	•	7502	3M™ Half Facepiece Reusable Respirator 7502, Medium, 10 Each/Case
7000104178	XA007709349	•	•	7503	3M™ Half Facepiece Reusable Respirator 7503, Large, 10 Each/Case
7000001938	AT010587411 (AUS) 70070317139 (NZ)	•	•	504	3M™ Respirator Cleaning Wipe 504, 100 Each/Pack, 500 Each/Case

For spare parts and accessories refer to the Part & Accessories pages

## 3M™ Half Facepiece Reusable Respirator, 6500QL Series

- Complies with AS/NZS 1716:2012 Respiratory Protective Devices

### Features and Benefits:

#### Adjustable Head Harness Assembly

#### 3M™ Cool Flow™ Valve

- Helps release warm and moist exhaled breath from inside the respirator
- Allows for easy breathing

#### Silicone Face Seal

- Designed for comfort, durability, and stability with a firm, lightly textured silicone face seal



#### Valve Cover Design

- Directs exhaled breath and moisture downward



#### Quick Latch Drop-Down Mechanism

- Easy on and off for moving in and out of contaminated areas
- No need for hard hat or faceshield removal when lowering or raising facepiece

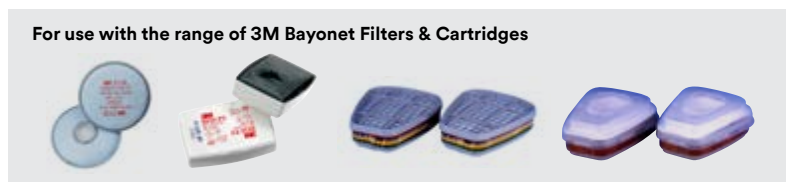

SAP ID	Legacy ID	Availability		Model #	Description
		AUS	NZ		
7100020699	70071668134	•	•	6501QL	3M™ Rugged Comfort Quick Latch Half Facepiece Reusable Respirator 6501QL, Small, 10 Each/Case
7100018994	70071668142	•	•	6502QL	3M™ Rugged Comfort Quick Latch Half Facepiece Reusable Respirator 6502QL, Medium, 10 Each/Case
7100018995	70071668159	•	•	6503QL	3M™ Rugged Comfort Quick Latch Half Facepiece Reusable Respirator 6503QL, Large, 10 Each/Case
7000001938	AT010587411 (AUS) 70070317139 (NZ)	•	•	504	3M™ Respirator Cleaning Wipe 504, 100 Each/Pack, 500 Each/Case

For spare parts and accessories refer to the Part & Accessories pages

# 3M™ Half Facepiece Reusable Respirator, 6000 Series

## Features and Benefits:

- Provides lightweight, easy-to-use, economical protection
- An economical choice
- Facepiece is made from soft, lightweight thermoplastic elastomer
- Head harness assembly and spare parts available
- Complies with AS/NZS 1716:2012 Respiratory Protective Devices



6100 Small



6200 Medium



6300 Large

For use with the range of 3M Bayonet Filters & Cartridges



Available in a range of Kits



SAP ID	Legacy ID	Availability		Model #	Description
		AUS	NZ		
7000146845	XA007702633	•	•	6100	3M™ Half Facepiece Reusable Respirator 6100, Small, 8 Each/Case
7000146847	XA007702658	•	•	6200	3M™ Half Facepiece Reusable Respirator 6200, Medium, 8 Each/Case
7000146849	XA007702674	•	•	6300	3M™ Half Facepiece Reusable Respirator 6300, Large, 8 Each/Case
7000001938	AT010587411 (AUS) 70070317139 (NZ)	•	•	504	3M™ Respirator Cleaning Wipe 504, 100 Each/Pack, 500 Each/Case

For spare parts and accessories refer to the Part & Accessories pages

# 3M™ Ultimate FX Full Facepiece Reusable Respirator, FF-400 Series

## Features and Benefits:

### Large lens provides a wide field of view

- Meets AS/NZS 1337:1:2010 Standard for eye and face protection Medium Impact

### Speaking Diaphragm

- Speaking Diaphragm for easy communication

### Bonded Silicone Gaskets

- Eliminate loose gaskets that can be lost

### 3M™ Cool Flow™ Valve

- Helps release warm and moist exhaled breath from inside the respirator
- Allows for easy breathing

### Durable, Long-lasting Head Harness

- Features a six-strap configuration for a secure fit

### Comfort Cradle

- Helps position the respirator more comfortably on the head

### Soft, Silicone Nose Cup and Faceseal

- Engineered for durability and comfort

## Compatible with:



TR-600 & BT-63/64



TR-800 & BT-63/64

Refer to Powered Air Purifying Respirator and Airline Sections for more information

## Accessories



102



FF-400-15

## For use with the range of 3M Bayonet Filters & Cartridges



QR-RR-19

Scan or Click for Tech Data Sheet



QR-RR-20

Scan or Click for Fitting Poster



QR-RR-21

Scan or Click for Training Videos

SAP ID	Legacy ID	Availability		Model #	Description
		AUS	NZ		
7000029940	70071510773	•	•	FF-401	3M™ Ultimate FX Full Facepiece Reusable Respirator FF-401, Small, 4 ea/Case
7000002284	70071510807	•	•	FF-402	3M™ Ultimate FX Full Facepiece Reusable Respirator FF-402, Medium, 4 ea/Case
7100001847	70071510831	•	•	FF-403	3M™ Ultimate FX Full Facepiece Reusable Respirator FF-403, Large, 4 ea/Case
7000029958	70071516978	•	•	FF-400-15	3M™ Lens Cover FF-400-15, 100 ea/Bag
7100254233	XA006514674	•	•	102	3M™ Universal Spectacle Kit 102, 1 ea/Case
7000001938	AT010587411 (AUS) 70070317139 (NZ)	•	•	504	3M™ Respirator Cleaning Wipe 504, 100 Each/Pack, 500 Each/Case

For spare parts and accessories refer to the Part & Accessories pages

## 3M™ Full Facepiece Reusable Respirator, 6000 Series

The 3M™ Full Face Reusable Respirator 6000 Series is simple to use and comfortable to wear. Combined with a broad range of twin, lightweight 3M™ filters or cartridges to provide respiratory protection against particulates and a variety of gases and vapours.

### Features and Benefits:

- Compatible with TR-600 & TR-800 Versaflo PAPR with BT-63 or BT-64 breathing tubes
- Compatible with Dual Airline Stethoscope Airline Systems 902-03-15
- Complies with AS/NZS 1716:2012 Respiratory Protective Devices

#### Four-point Harness

- Four straps help create a balanced and comfortable feel on the head

#### Silicone Faceseal

- Helps provide comfort

- Meets AS/NZS 1337:1:2010 Standard for eye and face protection High Impact



#### Large Lens

- Provides a wide field of view

#### 3M™ Cool Flow™ Valve

- Helps release warm and moist exhaled breath from inside the respirator
- Allows for easy breathing

#### Center Adapter

- Directs exhaled breath and moisture downward

6800 Medium

6700 Small



6900 Large

### Compatible with:



TR-600 & BT-63/64



TR-800 & BT-63/64



902-03-15 & Supplied air hose with Air panel

Refer to Powered Air Purifying Respirator and Continuous Flow Airline Sections for more information

### Accessories



6885



6886



102

### For use with the range of 3M Bayonet Filters & Cartridges



Available in a range of Kits



6835 P3

6851 A1P2



Scan or Click for Tech Data Sheet



Scan or Click for Fitting Poster



Scan or Click for Training Videos

SAP ID	Legacy ID	Availability		Model #	Description
		AUS	NZ		
7100015974	XA007708234	•	•	6700	3M™ Reusable Full Face Mask 6700, Small, 1 ea/Box, 4 Boxes/Case
7100015051	XA007708242	•	•	6800	3M™ Reusable Full Face Mask 6800, Medium, 1 ea/Box, 4 Boxes/Case
7100015052	XA007708259	•	•	6900	3M™ Reusable Full Face Mask 6900, Large, 1 ea/Box, 4 Boxes/Case
7100138628	70070709103	•	•	6885	3M™ Reusable Respirator Full Facepiece Faceshield Stacked Cover 6800
7000052088	AT019223489 (AUS) 70070799419 (NZ)	•	•	6886	3M™ Tinted Lens Cover 6886, Accessory 25 EA/Bag
7100254233	XA006514674	•	•	102	3M™ Universal Spectacle Kit 102, 1 ea/Case
7000001938	AT010587411 (AUS) 70070317139 (NZ)	•	•	504	3M™ Respirator Cleaning Wipe 504, 100 Each/Pack, 500 Each/Case

For spare parts and accessories refer to the Part & Accessories pages

## 3M™ Bayonet Particulate Filters Series

- Made from 3M high performance filter media for effective filtration efficiency
- Lightweight and provides low breathing resistance



2125 P2



**2125**  
QR-RR-25  
Scan or Click for  
Tech Data Sheet



2128 GP2  
with nuisance level OV/AG



**2128**  
QR-RR-26  
Scan or Click for  
Tech Data Sheet



502



2135 P3\*\*



**2135**  
QR-RR-27  
Scan or Click for  
Tech Data Sheet



2138 GP2/P3\*\*  
with nuisance level OV/AG



**2138**  
QR-RR-28  
Scan or Click for  
Tech Data Sheet

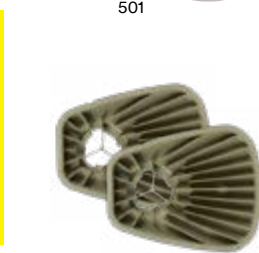

603



2076 P2HF



**2076**  
QR-RR-29  
Scan or Click for  
Tech Data Sheet



6035 P2/P3\*\*

6038 P2/P3\*\*/HF  
with nuisance level OV/AG



**6035/6038**  
QR-RR-30  
Scan or Click for  
Tech Data Sheet



5925 P2



**5925**  
QR-RR-31  
Scan or Click for  
Tech Data Sheet



5935 P3\*\*



**5935**  
QR-RR-32  
Scan or Click for  
Tech Data Sheet

### Suitable Facepieces compatible with 3M™ Bayonet filters and cartridges



6000 Half Face



6500QL



7500



6000 Full Face



FF-400

SAP ID	Legacy ID	Availability		Model #	Description
		AUS	NZ		
7010384001	70071486180	•	•	2125	3M™ Particulate Filter 2125, P2, 1 Pair Filter/Pack, 50 Packs/Case
7010301774	70071486206	•	•	2135	3M™ Particulate Filter 2135, P2/P3**, 1 Pair Filter/Pack, 50 Packs/Case
7000029913	70071486198	•	•	2128	3M™ Particulate Filter 2128, GP2, with Nuisance Level* Organic Vapor/Acid Gas Relief, 1 Pair/Pack, 50 Packs/Case
7000029914	70071486214	•	•	2138	3M™ Particulate Filter 2138, P2/P3**, with Nuisance Level Organic Vapor Relief, 100 EA/Case
7000021310	70070757912	•	•	2076HF	3M™ Particulate Cartridge 2076HF, Hydrogen Fluoride, P95/P2HF, with Nuisance Level Acid Gas Relief 100 EA/Case
7000037674	TI551152299	•	•	5925	3M™ Filters for Dust 5925, P2, 1 Pair/Pack, 10 Packs/Box, 4 Boxes/Case
7000037675	TI551152356	•	•	5935	3M™ Particulate Filters 5935, P3**, 80 EA/Case
7100211073	AT010794884 (AUS) 70071731957 (NZ)	•	•	501	3M™ Filter Retainer 501, 100 EA/Case. Filter retainer for 5925/5935 or 603 filter adaptor or 6000 Series Gas and Vapour
7000001931	AT019223455 (AUS) 70070313211 (NZ)	•	•	502	3M™ Filter Adapter 502, 100 EA/Case
7100066104	70071651759	•	•	603	3M™ Filter Adapter 603, 16 ea/Case. For use with 5925/5935. Requires 501A retainer.
7000032083	CR180811885	•	•	6035	3M™ Particulate Filter 6035 P3**, 80 EA/Case
7000059883	CR180811893	•	•	6038	3M™ Hydrogen Fluoride Particulate Filter 6038, P3**, with Nuisance Level* Organic Vapor and Acid Gas Relief, 20 ea/Pack, 80 ea/Case

\* Nuisance Levels are those levels below the Workplace Exposure Standard (WES)/Workplace Exposure Limit (WEL) \*\* Provides P3 protection only with 3M Full Facepiece Respirators. Provides P2 protection with half facepiece respirators.

## 3M™ Bayonet Gas and Vapour Cartridge Series

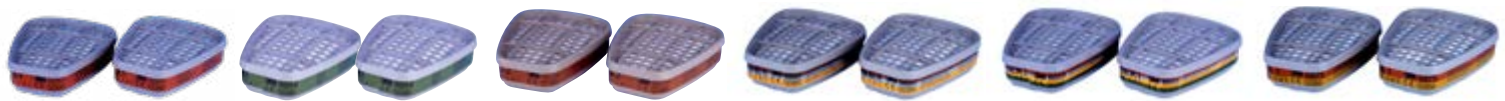

<p>6051 A1</p> <p><b>6051</b></p> <p>QR-RR-33</p> <p>Scan or Click for Tech Data Sheet</p>	<p>6054 K1</p> <p><b>6054</b></p> <p>QR-RR-34</p> <p>Scan or Click for Tech Data Sheet</p>	<p>6055 A2</p> <p><b>6055</b></p> <p>QR-RR-35</p> <p>Scan or Click for Tech Data Sheet</p>	<p>6057 A1B1E1</p> <p><b>6057</b></p> <p>QR-RR-36</p> <p>Scan or Click for Tech Data Sheet</p>	<p>6059 A1B1E1K1</p> <p><b>6059</b></p> <p>QR-RR-37</p> <p>Scan or Click for Tech Data Sheet</p>	<p>6075 A1Form</p> <p><b>6075</b></p> <p>QR-RR-38</p> <p>Scan or Click for Tech Data Sheet</p>
--	--	--	--	--	--



<p>6096 A1E1HgP3</p> <p><b>6096</b></p> <p>QR-RR-39</p> <p>Scan or Click for Tech Data Sheet</p>	<p>6098 AXP3 Use with Full facepiece only</p> <p><b>6098</b></p> <p>QR-RR-40</p> <p>Scan or Click for Tech Data Sheet</p>	<p>6099 A2B2E2K2HgP3 + Form Use with Full facepiece only</p> <p><b>6099</b></p> <p>QR-RR-41</p> <p>Scan or Click for Tech Data Sheet</p>	<p>60926 A1B1E1K1Form/HFP3</p> <p><b>60926</b></p> <p>QR-RR-42</p> <p>Scan or Click for Tech Data Sheet</p>
--	---	--	---

QR-CAT-SLS

For assistance in determining 3M Bayonet gas/vapour cartridge breakthrough and filter change schedules for certain gas/vapour contaminants visit the free

**3M Select and Service Life (SLS) Software |**  
[www.3m.com/sls](http://www.3m.com/sls)

SAP ID	Legacy ID	Availability		Model #	Description
		AUS	NZ		
7100098275	UU006790313	•	•	6051	3M™ Organic Vapour Cartridge Filter 6051, A1, 1 Pair/Pack, 30 Packs/Case. For Organic Vapours with >65 degrees celsius boiling point
7000034749	GT500084048	•		6055	3M™ Organic Vapour Cartridge Filter 6055, A2, 4 Packs/Box, 8 Boxes/Carton, 32 Packs/Case. For Organic Vapours with >65 degrees celsius boiling point
7100097156	UU006790354	•	•	6057	3M™ Organic Vapour/Acid Gas Cartridge Filter 6057, A1B1E1, 1 Pair/Pack, 30 Packs/Case. For Organic Vapours with >65 degrees celsius boiling point
7000034750	AT010561440 (AUS) GT500084055 (NZ)	•	•	6054	3M™ Gas and Vapour Filters 6054, K1 Ammonia, 64 EA/Case
7100098276	UU006790370	•	•	6075	3M™ Formaldehyde/Organic Vapour Cartridge Filter 6075, A1 Form, 1 Pair/Pack, 30 Packs/Case. For Organic Vapours with >65 degrees celsius boiling point
7100097157	UU006790362	•	•	6059	3M™ Multi Gas/Vapour Cartridge Filter 6059, A1B1E1K1, 1 Pair/Pack, 30 Packs/Case. For Organic Vapours with >65 degrees celsius boiling point
7100104296	70071695228	•	•	6096	3M™ Gas, Organic Vapour, Sulfur Dioxide, Mercury and Particulate Filter 6096, A1E1HgP3, 32 EA/Case. For Organic Vapours with >65 degrees celsius boiling point
7000002041	70070709483	•		60926	3M™ Multi Gas/Vapour Cartridge/Filter 60926, A1B1E1K1Form P100/P3 60 EA/Case. Multi Gas Organic Vapour (>65 degrees celsius boiling point), Acid Gases, Ammonia, formaldehyde and hydrogen fluoride cartridge and particulate.
7000021315	70071617974*	•	•	6098	3M™ Organic Vapour and Particulate Cartridge Filter 6098, AXP3, 4 ea/Pack, 32 ea/Case. For Organic Vapours with <65 degrees celsius boiling point.
7100104327	70071695210*	•	•	6099	3M™ MultiGas, A2B2E2K2HgP3 + Formaldehyde Filter 6099, 32 ea/Case. Organic Vapour >65 degrees celsius boiling point, Acid Gas, Ammonia, Mercury, formaldehyde, HF and Particulate Filter

### Particulate Filter and Gas/Vapour Cartridge Combination Assembly

3M™ Bayonet Filter facepieces

6000 Series Gas & Vapour cartridges + 5925/5935 + 501

603 Adapter + 5925/5935 + 501

6000 Series Gas & Vapour cartridges + 502 Adapter + 2000 Particulate Series OR 6035/6038

\* Use with Full facepiece only

## Reusable Respirators 3M™ Bayonet Starter Kits

# 3M™ Bayonet Reusable Respirator Half Facepiece Starter Kits.

These kits are designed to offer respiratory protection in a convenient and easy way – an ideal solution to get you started. The kits provide protection for a range of applications, from spray painting to sanding or welding. To avoid moisture and contaminant exposure, the respirator is housed in a handy, sealable storage container.

### 3M™ Spraying Respirator Kit 6551QL

A convenient respiratory kit designed for certain painting\* and spraying environments. The kit comes complete with the 3M™ Half Face Reusable 6500QL Respirator for comfort and durability. It features 3M™ Cool Flow™ Exhalation Valve which reduces breathing resistance and minimize heat build-up. The Quick Latch drop down mechanism provides ease in donning and doffing the facepiece.

#### Kit includes

- 1 x 6500QL Series half facepiece
- 1 Pair x 6051 A1 Organic Vapour (b.pt >65°C) Cartridge
- 1 Pair x 5925 P2 Particulate filter
- 1 Pair x 501A Retainer
- 1 x storage container

\*Not to be used when spraying isocyanate based paints



QR-RR-43  
Scan or Click for Tech Data Sheet

SAP ID	Legacy ID	Availability		Model #	Description
		AUS	NZ		
7012885945 (AUS) 7012887000(NZ)	AT010623794 (AUS) AT010787870 (NZ)	•	•	6551QL	3M™ Spraying Respirator Kit 6551QL, A1P2, Small, 2 ea/Case
7012885539 (AUS) 7012869457(NZ)	AT010623802 (AUS) AT010787862 (NZ)	•	•	6551QL	3M™ Spraying Respirator Kit 6551QL, A1P2, Medium, 2 ea/Case
7012867749 (AUS) 7012886518(NZ)	AT010623810 (AUS) AT010782178 (NZ)	•	•	6551QL	3M™ Spraying Respirator Kit 6551QL, A1P2, Large, 2 ea/Case

For spare parts and accessories refer to the Part & Accessories pages

### 3M™ Spraying Respirator Kit 7551

A convenient respiratory kit designed for certain painting\* and spraying environments. The kit comes complete with the 3M™ Half Face Reusable 7500 Series Respirator for comfort and durability. The 3M™ Cool Flow™ Exhalation Valve reduces breathing resistance and minimizes heat build-up.

#### Kit includes

- 1 x 7500 Series half facepiece
- 1 Pair x 6051 A1 Organic Vapour (b.pt >65°C) Cartridge
- 2 Pair x 5925 P2 Particulate filter
- 1 Pair x 501A Retainer
- 1 x storage container

\*Not to be used when spraying isocyanate based paints



QR-RR-44  
Scan or Click for Tech Data Sheet

SAP ID	Legacy ID	Availability		Model #	Description
		AUS	NZ		
7012874773 (AUS) 7012886950(NZ)	AT010623372 (AUS) NT019446581 (NZ)	•	•	7551	3M™ Spraying Respirator Kit 7551, A1P2, Small, 2 Kits/Case
7012887713 (AUS) 7012867515(NZ)	AT010623380 (AUS) NT019446573 (NZ)	•	•	7551	3M™ Spraying Respirator Kit 7551, A1P2, Medium, 2 Kits/Case
7012888953 (AUS) 7012882652 (NZ)	AT010623398 (AUS) NT019446565 (NZ)	•	•	7551	3M™ Spraying Respirator Kit 7551, A1P2, Large, 2 Kits/Case

For spare parts and accessories refer to the Part & Accessories pages

# Reusable Respirators 3M™ Bayonet Starter Kits

## 3M™ Spraying Respirator Kit 6251

A convenient respiratory kit designed for certain painting\* and spraying environments. The kit comes complete with the 3M™ Half Face Reusable 6000 Series Respirator for comfort and durability.

### Kit includes

- 1 x 6000 Series half facepiece
- 1 Pair x 6051 A1 Organic Vapour (b.pt >65°C) Cartridge
- 1 Pair x 5925 P2 Particulate filter
- 1 Pair x 501A Retainer
- 1 x storage container

\* Not to be used when spraying isocyanate based paints



QR-RR-45

Scan or Click for Tech Data Sheet

SAP ID	Legacy ID	Availability		Model #	Description
		AUS	NZ		
7012876282 (AUS)	AT010782442 (AUS)	•	•	6251	3M™ Spraying Respirator Kit 6251, A1P2, Small, 2 Kits/Case
7012890678 (NZ)	NT019447951 (NZ)				
7012877767 (AUS)	AT010783671 (AUS)	•	•	6251	3M™ Spraying Respirator Kit 6251, A1P2, Medium, 2 Kits/Case
7012887903 (NZ)	NT019447969 (NZ)				
7012871341 (AUS)	AT010782434 (AUS)	•	•	6251	3M™ Spraying Respirator Kit 6251, A1P2, Large, 2 Kits/Case
7012887555 (NZ)	NT019447977 (NZ)				

For spare parts and accessories refer to the Part & Accessories pages

## 3M™ Welding Respirator Kit 6228

Includes a 3M™ Half Face 6000 Series Respirator that is simple and lightweight.

### Kit includes

- 1 x 6000 Series half facepiece
- 1 x 2128 GP2 Particulate, Ozone & with nuisance level\* organic vapour/acid gas filter Pair
- 1 x storage container



QR-RR-46

Scan or Click for Tech Data Sheet

SAP ID	Legacy ID	Availability		Model #	Description
		AUS	NZ		
7012888914	AT019448086	•		6228	3M™ Welding Respirator Kit 6228, GP2, Medium, 2 Kits/Case

For spare parts and accessories refer to the Part & Accessories pages

## 3M™ Welding Respirator Kit 7528

Includes a 3M™ Half Face 7500 Series Respirator with special Cool Flow™ valve and soft silicone material. Ideal for working in hot and humid conditions or during prolonged use.

### Kit includes

- 1 x 7500 Series half facepiece
- 1 x 2128 GP2 Particulate, Ozone & with nuisance level\* organic vapour/acid gas filter Pair
- 1 x storage container



QR-RR-47

Scan or Click for Tech Data Sheet

SAP ID	Legacy ID	Availability		Model #	Description
		AUS	NZ		
7012868205 (AUS)	AT019448094 (AUS)	•	•	7528	3M™ Welding Respirator Kit 7528, GP2, Medium, 2 Kits/Case
7012869045 (NZ)	NT019447993 (NZ)				

For spare parts and accessories refer to the Part & Accessories pages

# Reusable Respirators 3M™ Bayonet Starter Kits

## 3M™ Welding/Particulate Kit 6528QL

The kit comes complete with the 3M™ Half Face Reusable 6500QL Respirator for comfort and durability. It features 3M™ Cool Flow™ Exhalation Valve that reduces breathing resistance and minimizes heat build-up. The Quick Latch drop down mechanism provides ease in donning and doffing the facepiece.

### Kit includes

- 1 x 6500QL Series half facepiece
- 2 x 2128 GP2 Particulate, Ozone & with nuisance level\* organic vapour/acid gas filter Pair
- 1 x storage container



QR-RR-48

Scan or Click for Tech Data Sheet

SAP ID	Legacy ID	Availability		Model #	Description
		AUS	NZ		
7012877075	AT010623406	•		6528QL	3M™ Welding/Particulate Respirator Kit 6528QL, GP2, Small, 2 ea/Case
7012886661 (AUS) 7012867035 (NZ)	AT010623414 (AUS) NT019446607 (NZ)	•	•	6528QL	3M™ Welding/Particulate Respirator Kit 6528QL, GP2, Medium, 2 ea/Case
7012890637 (AUS) 7012881003 (NZ)	AT010623422 (AUS) NT019446607 (NZ)	•	•	6528QL	3M™ Welding/Particulate Respirator Kit 6528QL, GP2, Large, 2 ea/Case

For spare parts and accessories refer to the Part & Accessories pages.

\* Nuisance Levels are those levels below the Workplace Exposure Standard (WES)/Workplace Exposure Limit (WEL)

## 3M™ Multi-Gas Respirator Kit 6259

Includes a 3M™ Half Face 6000 Series Respirator that is simple and lightweight.

### Kit includes

- 1 x 6000 Series half facepiece
- 1 Pair x 6059 A1B1E1K1 Multi Gas Cartridge
- 1 Pair x 5925 P2 Particulate filter
- 1 Pair x 501A Retainer
- 1 x storage container

\*Not to be used when spraying isocyanate based paints



QR-RR-49

Scan or Click for Tech Data Sheet

SAP ID	Legacy ID	Availability		Model #	Description
		AUS	NZ		
7012886751	AT010782467	•		6259	3M™ Multi-Gas Respirator Kit 6259, A1B1E1K1P2, Small, 2 Kits/Case
7012892401 (AUS) 7012870460 (NZ)	AT010783689 (AUS) NT019447985 (NZ)	•	•	6259	3M™ Multi-Gas Respirator Kit 6259, A1B1E1K1P2, Medium, 2 Kits/Case
7012884712	AT010782459	•		6259	3M™ Multi-Gas Respirator Kit 6259, A1B1E1K1P2, Large, 2 Kits/Case

For spare parts and accessories refer to the Part & Accessories pages

## 3M™ Construction Respirator Kit 6535QL

The kit comes complete with the 3M™ Half Face Reusable 6500QL Respirator for comfort and durability. It features 3M™ Cool Flow™ Exhalation Valve that reduces breathing resistance and minimizes heat build-up. The Quick Latch drop down mechanism provides ease in donning and doffing the facepiece.

### Kit includes

- 1 x 6500QL Series half facepiece
- 2 x 6035 P2/P3\* Particulate filter Pair
- 1 x storage container

\*Provides P2 protection with half facepiece respirator. Provide P3 Protection only with full facepiece respirator.



QR-RR-50

Scan or Click for Tech Data Sheet

SAP ID	Legacy ID	Availability		Model #	Description
		AUS	NZ		
7012881491 (AUS) 7012881573 (NZ)	AT010782475 (AUS) NT019449288 (NZ)	•	•	6535QL	3M™ Construction Respirator Kit 6535QL, P2, Small, 2 Kits/Case
7012884402 (AUS) 7012882831 (NZ)	AT010782483 (AUS) NT019448009 (NZ)	•	•	6535QL	3M™ Construction Respirator Kit 6535QL, P2, Medium, 2 Kit/Case
7012890982 (AUS) 7012881077 (NZ)	AT010782491 (AUS) NT019448017 (NZ)	•	•	6535QL	3M™ Construction Respirator Kit 6535QL, P2, Large, 2 Kits/Case

For spare parts and accessories refer to the Part & Accessories pages

# Reusable Respirators 3M™ Bayonet Starter Kits

## 3M™ Dust/Particle Respirator Kit 6225

Includes a 3M™ Half Face 6000 Series Respirator that is simple and lightweight.

### Kit includes

- 1 x 6000 Series half facepiece
- 1 x 2125 P2 Particulate filter Pair
- 1 x storage container



QR-RR-51

Scan or Click for Tech Data Sheet

SAP ID	Legacy ID	Availability		Model #	Description
		AUS	NZ		
7012882257 (AUS) 7012873920 (NZ)	AT010782426 (AUS) NT019447928 (NZ)	•	•	6225	3M™ Dust/Particle Respirator Kit 6225, P2, Small, 2 Kits/Case
7012893159 (AUS) 7012872509 (NZ)	AT010783663 (AUS) NT019447936 (NZ)	•	•	6225	3M™ Dust/Particle Respirator Kit 6225, P2, Medium, 2 Kits/Case
7012879815 (AUS) 7012869659 (NZ)	AT010782418 (AUS) NT019447944 (NZ)	•	•	6225	3M™ Dust/Particle Respirator Kit 6225, P2, Large, 2 Kits/Case

For spare parts and accessories refer to the Part & Accessories pages

## 3M™ Asbestos/Dust Respirator Kit 7535

A convenient respiratory kit designed for certain\*\* asbestos tasks and environments containing dust. The kit comes complete with the 3M™ Half Face Reusable Respirator 7500 Series for comfort and durability. The respirator design helps reduce fogging when wearing eye protection.

### Kit includes

- 1 x 7500 Series half facepiece
- 2 x 6035 P2/P3\* Particulate filter Pair
- 1 x storage container

\*Provides P2 protection with half facepiece respirator. Provide P3 Protection only with full facepiece



QR-RR-52

Scan or Click for Tech Data Sheet

SAP ID	Legacy ID	Availability		Model #	Description
		AUS	NZ		
7012866966	AT010601592	•	•	7535S	3M™ Asbestos/Dust Respirator Kit 7535, P2/P3, Small, 2 Kits/Case
7012869567	AT010601600	•	•	7535M	3M™ Asbestos/Dust Respirator Kit 7535, P2/P3, Medium, 2 Kits/Case
7012884104	AT010601618	•	•	7535L	3M™ Asbestos/Dust Respirator Kit 7535, P2/P3, Large, 2 Kits/Case

For spare parts and accessories refer to the Part & Accessories pages



ID 2194323  
RID 2182327

## Reusable Respirators 3M™ Bayonet Starter Kits

# 3M™ Bayonet Reusable Respirator Full Facepiece Starter Kits.

A convenient respiratory kit designed for certain asbestos tasks painting and spraying and environments containing dust. The kit comes complete with the 3M™ Full Face Reusable 6000 Series Respirator for comfort and durability. The respirator is simple and easy to use, well balanced and provides a wide field of vision.

### 3M™ Asbestos/Dust Respirator Kit 6835, P3

**Kit includes**

- 1 x 6000 Series full facepiece
- 2 x 6035 P2/P3\* Particulate filter Pair
- 1 x storage container



QR-RR-53

Scan or Click for Tech Data Sheet

SAP ID	Legacy ID	Availability		Model #	Description
		AUS	NZ		
7012870547	AT010614199	•	•	6835S	3M™ Asbestos/Dust Respirator Kit 6835, P3*, Small, 1 Kit/Case
7012891426	AT010614207	•	•	6835M	3M™ Asbestos/Dust Respirator Kit 6835, P3, Medium, 1 Kit/Case
7012886094	AT010614215	•	•	6835L	3M™ Asbestos/Dust Respirator Kit 6835, P3*, Large, 1 Kit/Case

For spare parts and accessories refer to the Part & Accessories pages.

\*Provides P2 protection with half facepiece respirator. Provide P3 Protection only with full facepiece

### 3M™ Spraying/Painting Respirator Kit 6851 A1P2

**Kit includes**

- 1 x 6000 Series full facepiece
- 1 Pair x 6051 A1 Organic Vapour (b.pt >65°C) Cartridge
- 5 Pair x 5925 P2 Particulate filter
- 1 Pair x 501A Retainer
- 1 x storage container

\*Not to be used when spraying isocyanate based paints



QR-RR-54

Scan or Click for Tech Data Sheet

SAP ID	Legacy ID	Availability		Model #	Description
		AUS	NZ		
7012867399	AT010614173	•	•	6851M	3M™ Spraying/Painting Respirator Kit 6851, A1P2. Medium, 1 Kit/Case
7012883387	AT010614181	•	•	6851L	3M™ Spraying/Painting Respirator Kit 6851, A1P2, Large, 1 Kit/Case

For spare parts and accessories refer to the Part & Accessories pages

# Reusable Respirators 3M™ Bayonet Parts & Accessories

## 3M™ Reusable Respirator Half Face Accessories 6000

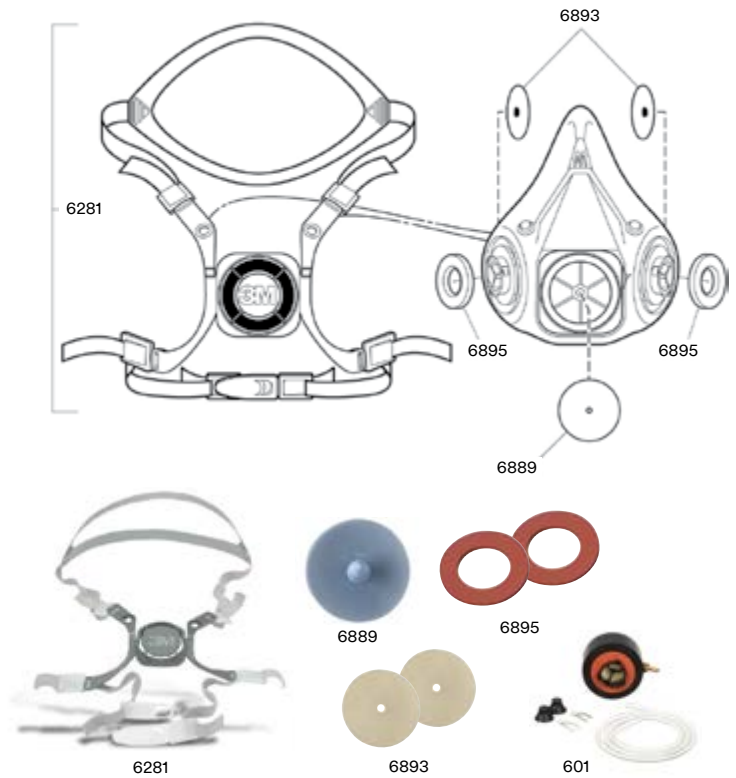

SAP ID	Legacy ID	Availability		Model #	Description
		AUS	NZ		
7000029677	70070846087	•	•	6281	3M™ Head Harness Assembly 6281–EUR, 20 ea/Case
7000002057	70070757656	•	•	6889	3M™ Exhalation Valve 6889/07143(AAD), 10 ea/Bag
7000002049	70070710986	•	•	6893	3M™ Inhalation Valve 6893/07144(AAD), System Component 200 EA/Case
7000002050	70070710994	•	•	6895	3M™ Reusable Respirator Gasket 6895, for 3M™ Reusable Full Face Mask 6000 Series, 4 Packs/Case
7000001945	70070406544	•	•	601	3M™ Fit Test Adapter 601, 1 ea/Case. 3M Bayonet QNFT-CNC

## 3M™ Half Face Respirator Accessories 6500QL

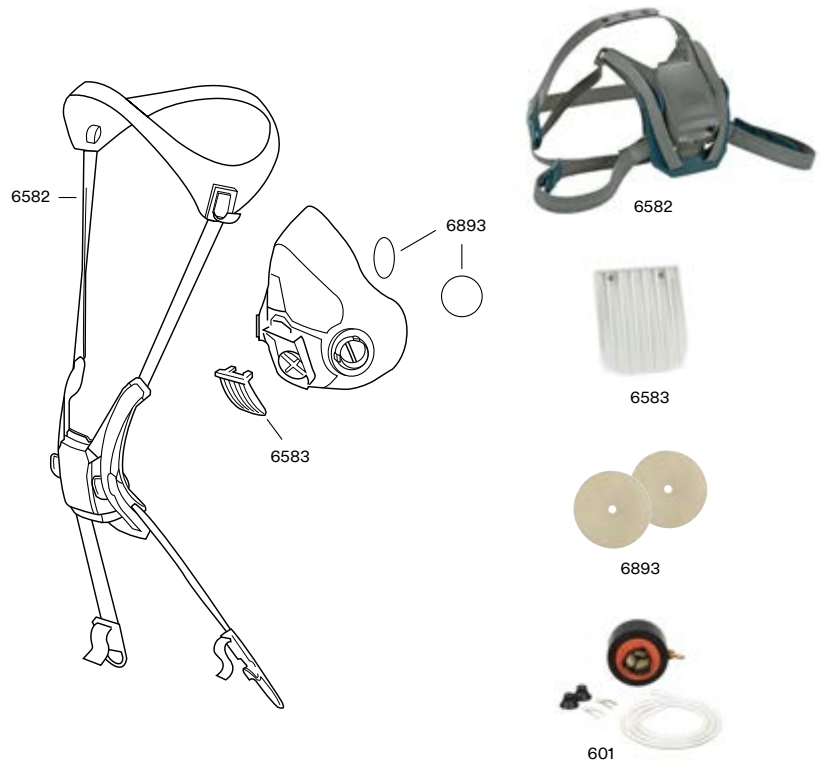

SAP ID	Legacy ID	Availability		Model #	Description
		AUS	NZ		
7100020701	70071668175	•	•	6582	3M™ Quick Latch Head Harness Assembly 6582QL, 20/Case
7100018862	70071668183	•	•	6583	3M™ Rugged Comfort Exhalation Valve 6583, 10/Case
7000002049	70070710986	•	•	6893	3M™ Inhalation Valve 6893/07144(AAD), System Component 200 EA/Case
7000001945	70070406544	•	•	601	3M™ Fit Test Adapter 601, 1 ea/Case. 3M Bayonet QNFT-CNC

Please note not all parts and accessories are stocked or active in our system. Please contact 3M sales rep or customers service for further clarification.

# Reusable Respirators 3M™ Bayonet Parts & Accessories

## 3M™ Half Face Respirator Accessories 7500

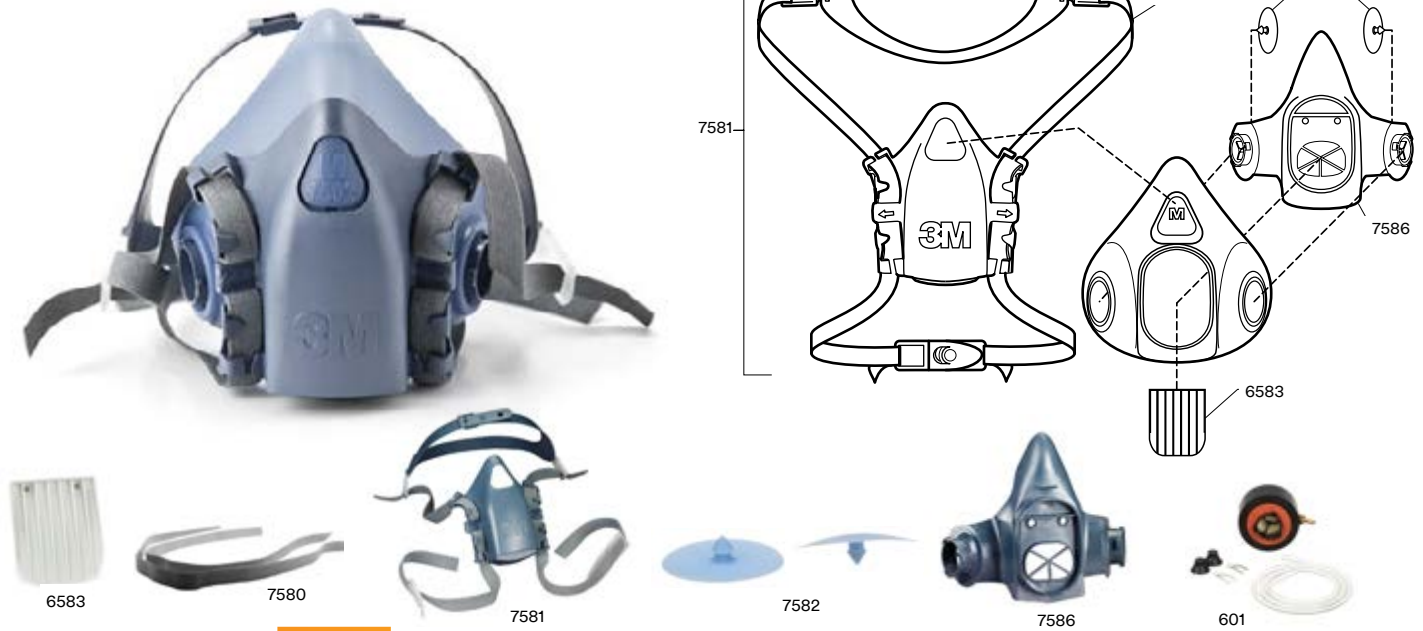

SAP ID	Legacy ID	Availability		Model #	Description
		AUS	NZ		
7100018862	70071668183	•	•	6583	3M™ Rugged Comfort Exhalation Valve 6583, 10/Case
7000127455	70071534294	•	•	7580	3M™ Respirator Replacement Strap 7580 40 EA/Bag
7000002157	AT010561499	•	•	7581	3M™ Head Harness Assembly 7581, System Component 20 EA/Case
7000002158	AT010561507	•	•	7582	3M™ Inhalation Valve 7582, Replacement Part 10 EA/Bag
7000002160	AT010561523	•	•	7586	3M™ Cartridge Filter Holder 7586, 20 EA/Case
7000001945	70070406544	•	•	601	3M™ Fit Test Adapter 601, 1 ea/Case. 3M Bayonet QNFT-CNC



Please note not all parts and accessories are stocked or active in our system. Please contact 3M sales rep or customers service for further clarification.

# Reusable Respirators 3M™ Bayonet Parts & Accessories

## 3M™ Reusable Respirator Full Face 6000 & 6000DIN Accessories

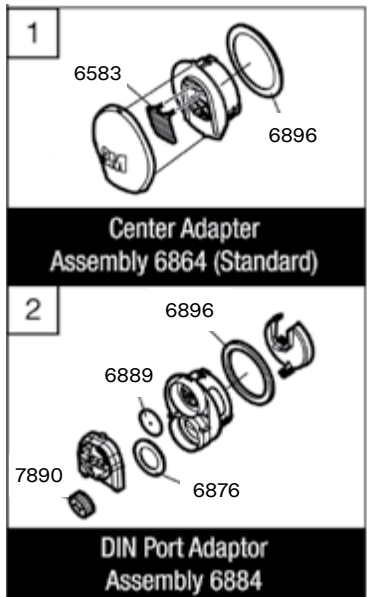

SAP ID	Legacy ID	Availability		Model #	Description
		AUS	NZ		
7100018862	70071668183	•	•	6583	3M™ Rugged Comfort Exhalation Valve 6583, 10/Case
7000002178	AT019223471	•	•	6864	3M™ Center Adapter Assembly 6864/37000(AAD), 5 EA/Case
7000126403	70070890176	•	•	6876	3M™ Breathing Tube Gasket 6876, 5 EA/Case
7100006233	70070757375	•	•	6880	3M™ Bayonet Cap 6880/37002(AAD), 10 ea/Bag
7000002032	AT019166936	•	•	6884	3M™ DIN Port Adapter Assembly 6884, 5 EA/Case
7100138628	70070709103	•	•	6885	3M™ Faceshield Cover 6885/07142(AAD), 100 ea/Bag
7000052088	AT019223489	•	•	6886	3M™ Tinted Lens Cover 6886, Accessory 25 EA/Bag
7000002057	70070757656	•	•	6889	3M™ Exhalation Valve 6889/07143(AAD), 10 ea/Bag
7000002049	70070710986	•	•	6893	3M™ Inhalation Valve 6893/07144(AAD), System Component 200 EA/Case
7000002034	70070709145 AT019167421	•	•	6894	3M™ Nose Cup Assembly 6894/37004(AAD), Replacement Part 5 EA/Case
7000002050	70070710994	•	•	6895	3M™ Reusable Respirator Gasket 6895, for 3M™ Reusable Full Face Mask 6000 Series, 4 Packs/Case
7000052122	70070847051	•	•	6896	3M™ Center Adapter Gasket 6896, 20 EA/Case
7000002035	70070709152 AT019167439	•	•	6897	3M™ Head Harness 6897/37005(AAD), 5 EA/Case
7000002036	70070709160 AT019167447	•	•	6898	3M™ Lens Assembly 6898/37006(AAD), Replacement Part 5 EA/Case
7100001832	70070709178	•	•	6899	3M™ Frame Kit 6899/37007(AAD), 5 EA/Case
7000029584	70070079150	•	•	7890	3M™ Full Face Plug 7890, Replacement Part 20 EA/Case
7100254233	XA006514674	•	•	102	3M™ Universal Spectacle Kit 102, 1 ea/Case
7000001945	70070406544	•	•	601	3M™ Fit Test Adapter 601, 1 ea/Case. 3M Bayonet QNFT-CNC
7100265515	XP100544970	•	•	SC-6611	3M™ Fit Test Adapter SC-6611, 1 ea/Case. DIN40 QNFT-CNC

Please note not all parts and accessories are stocked or active in our system. Please contact 3M sales rep or customers service for further clarification.

# Reusable Respirators 3M™ Bayonet Parts & Accessories

## 3M™ Full Face Respirator Accessories FF-400

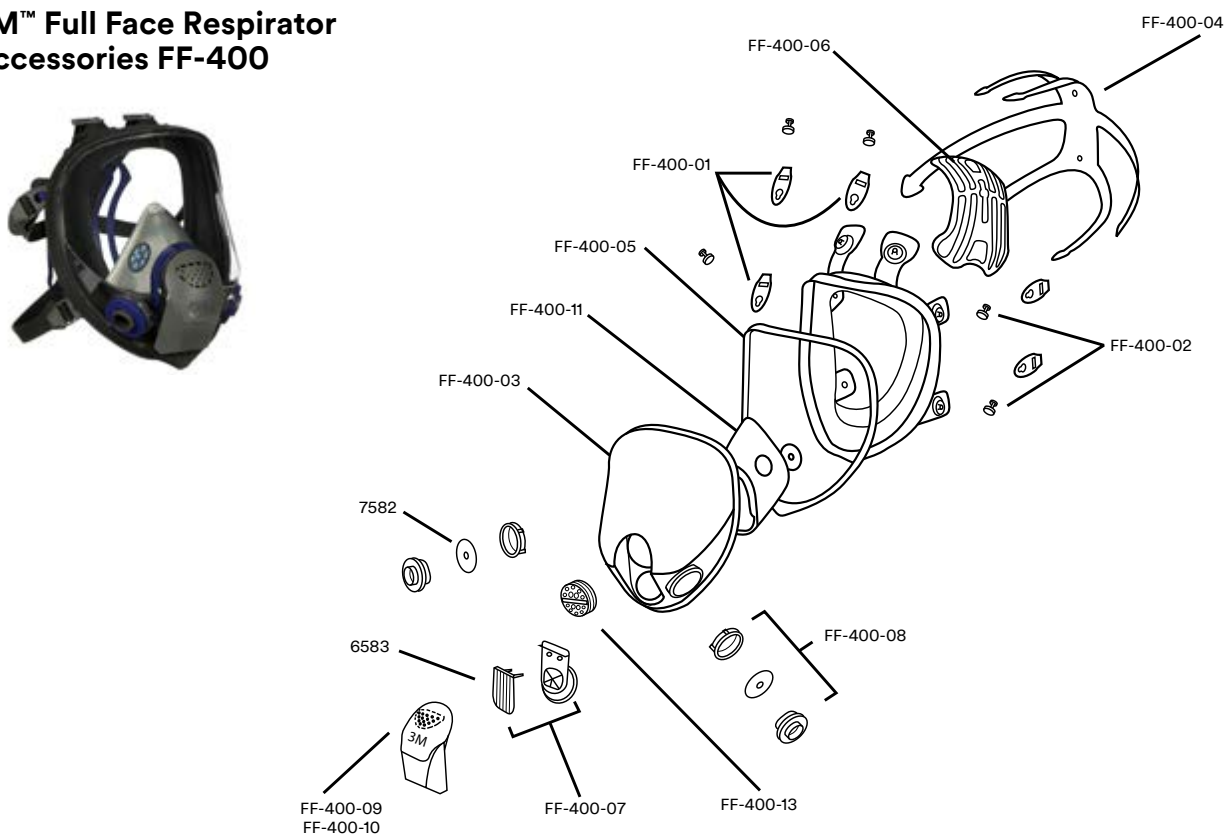

SAP ID	Legacy ID	Availability		Model #	Description
		AUS	NZ		
7000052734	70071516846	•	•	FF-400-01	3M™ Buckle FF-400-01, 30 EA/Case
7000052735	70071516853	•	•	FF-400-02	3M™ Button FF-400-02, 30 EA/Case
7100009686	70071516861 AT010593633	•	•	FF-400-03	3M™ Lens Replacement FF-400-03, Replacement Part 5 EA/Case
7100003369	70071516879	•	•	FF-400-04	3M™ Head Harness FF-400-04, 5 ea/Case
7000052736	70071516887	•	•	FF-400-05	3M™ Lens Frame Assembly FF-400-05, 5 EA/Case
7000052737	70071516895	•	•	FF-400-06	3M™ Comfort Cradle Head Harness Attachment FF-400-06, 5 EA/Case
7000052738	70071516903	•	•	FF-400-07	3M™ Exhalation Valve Assembly FF-400-07, 5 EA/Case
7000052739	70071516911	•	•	FF-400-08	3M™ Bayonet Assembly FF-400-08, 10 EA/Case
7000052740	70071516929	•	•	FF-400-09	3M™ Exhalation Valve Cover FF-400-09, 5 EA/Case
7000029957	70071516937	•	•	FF-400-10	Solid Exhalation Valve Cover
7000052741	70071516945	•	•	FF-400-11	3M™ Nose Cup Assembly FF-400-11, 5 ea/Case
7000052742	70071516960	•	•	FF-400-13	3M™ Speaking Diaphragm Assembly FF-400-13, 5 EA/Case
7000029958	70071516978	•	•	FF-400-15	3M™ FF-400-15 Lens Cover 100/Bag
7100018862	70071668183	•	•	6583	3M™ Rugged Comfort Exhalation Valve 6583, 10/Case
7000002158	AT010561507	•	•	7582	3M™ Inhalation Valve 7582, Replacement Part 10 EA/Bag
7100254233	XA006514674	•	•	102	3M™ Universal Spectacle Kit 102, 1 ea/Case
7000001945	70070406544	•	•	601	3M™ Fit Test Adapter 601, 1 ea/Case

Please note not all parts and accessories are stocked or active in our system. Please contact 3M sales rep or customers service for further clarification.

# 3M™ Wear it Right App



ID 2250703  
RID 2250698

This interactive guide is designed to help streamline your fit testing program. Designed to support multiple mobile devices, the 3M Wear it Right App can be used to test both half face reusable and disposable respirators according to OSHA and ISO qualitative fit test protocols. In addition to guiding fit testers and wearers step-by-step through the process, it also offers convenient digital data recording to aid record keeping for compliance needs. Not suitable for full facepiece respirators.

Refer Fit Testing Section for further information.



QR-WIR-IOS



[Download the app now on iOS.](#)



QR-WIR-GPL



[Download the app now on Google Play.](#)

Scan the QR code to download your free 3M™ Wear it Right App from the iOS or Google Play store.

# 3M™ Select and Service Life Software

Use our free software to help identify the appropriate cartridge selection for your respirator and work environment. Simply enter contaminants and their concentrations, and the software will provide a list of recommended options. It also offers a service life calculation tool to help you estimate how frequently to replace your gas/vapour cartridges. Both programs are simple, accurate and give printable reports.

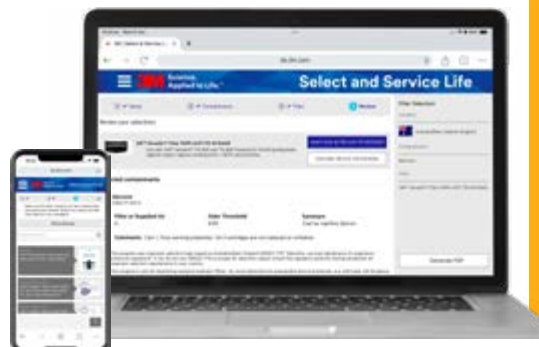

QR-CAT-SLS

For assistance in determining 3M™ Secure Click™ and 3M Bayonet gas/vapour cartridge breakthrough and filter change schedules for certain gas/vapour contaminants visit

**3M Select and Service Life (SLS) Software** | [www.3m.com/sls](http://www.3m.com/sls)

# 3M™ DT-Series Platform

3M™ Filters DT Series are designed to be used with approved 3M reusable half and full face respirators and certain 3M™ powered air respirators (see compatibility below).

### Product range

- 3M™ Particulate Filters DT-1000 Series
- 3M™ Gas and Vapour Filters DT-4000 Series
- 3M™ Gas, Vapour and Particulate Filters DT-403X and DT-404X Series



Replace 3M™ Particulate Filters DT-1000 Series when it becomes difficult to breathe comfortably (this will vary from individual to individual) or the filter becomes dirty or physical damage occurs. If used with a powered air respirator, the filter may need to be changed when the low flow alarm sounds. Refer to powered air respirator user instructions.

Replace 3M™ DT Series Gas & Vapour filters in accordance with your established change schedule or government regulation, or sooner if the contaminant can be detected inside the respirator by smell or taste. Note: If the filters also provide combined particulate protection, then the filter may need to be replaced as described above.

3M™ DT Series Filters (DIN40) can only be used with 3M™ reusable full face respirators and powered air respirators fitted with a DIN40mm screw thread connection, e.g. 3M™ Reusable Full Facepiece Respirator FF-300 Series, 3M™ Reusable Full Facepiece Respirator FF-600/FF-600F Series and 3M™ Powered Air Respirator PF-600-ASB.

Before use, check the expiration date. For other use limitations please refer to the User Information supplied with the products.



ID 1614205  
RID 1697875

# Reusable Respirators 3M™ DT-Series – Full Facepiece

## 3M™ Full Facepiece Reusable Respirator, FF-300 Series

- DIN40 threaded filter connection
- Wide range of high performance DT-Series filters available to address a variety of hazards
- Non allergenic halo butyl facepiece with wide panoramic polycarbonate visor
- Five point adjustable head harness provides increased wearer comfort and fit
- Speech diaphragm provides clear and audible speech transmission
- Polycarbonate visor
- Complies with AS/NZS 1716:2012 Respiratory Protective Devices
- Compatible with PF-600E-ASB PAPP

**Export controlled product. Document required to be signed upon purchase.**



For use with the range of 3M DT-Series Filters & Cartridges



**Compatible with:**



PF-600E-ASB

Refer to Powered Air Purifying Respirator and Airline Sections for more information

**Accessories**



FF-300-926



FF-300-20

SAP ID	Legacy ID	Availability		Model #	Description
		AUS	NZ		
7100237033	UU010978961	•	•	FF-301	3M™ Reusable Full Face Mask FF-301-S, Small, 4 ea/Case
7100236989	UU010978953	•	•	FF-302	3M™ Reusable Full Face Mask FF-302-M/L, Medium/Large, 4 ea/Case
7012623323	XP100544145	•	•	FF-300-926	3M™ Scott's Lens Covers FF-300-926/012698, 10/Pack
7012912362	XP100544160	•	•	FF-300-20	3M™ Scott's Prescription Spectacle Frame FF-300-20/012790

## 3M™ Full Facepiece Reusable Respirator, FF-600F Series

- The Vision visor provides a virtually unrestricted (98%) field of vision
- The visor curves through both the vertical and horizontal planes and remains optically perfect to prevent any visual distortion
- Hard coated to provide solvent and scratch resistance for low through-life costs
- Filters sit low and close to the face, providing excellent balance and weight distribution
- Front mounted filter
- Polycarbonate visor
- Complies with AS/NZS 1716:2012 Respiratory Protective Devices



**Accessories**

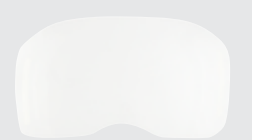

FF-600-926



FF-600-20

For use with the range of 3M DT-Series Filters & Cartridges



SAP ID	Legacy ID	Availability		Model #	Description
		AUS	NZ		
7100265075	UU011565585	•		FF-601F	3M™ Front-Fitting Reusable Full Face Mask, FF-601F, Small, 4 ea/Case
7100265074	UU011565593	•		FF-602F	3M™ Front-Fitting Reusable Full Face Mask, FF-602F Medium, 4 ea/Case
7100265236	UU015546932	•		FF-603F	3M™ Front-Fitting Reusable Full Face Mask FF-603F Large, 4 ea/Case
7100236084	UU010979506	•	•	FF-600-926	3M™ Visor Peel Offs FF-600-926, 20 ea/Case
7100236821	UU010979514	•	•	FF-600-20	3M™ Spectacle Kit FF-600-20, 4 ea/Case

# Reusable Respirators 3M™ DT-Series – Full Facepiece

## 3M™ Full Facepiece Reusable Respirator, FF-600 Series

- The Vision visor provides a virtually unrestricted (98%) field of vision
- The visor curves through both the vertical and horizontal planes and remains optically perfect to prevent any visual distortion
- Hard coated to provide solvent and scratch resistance for low through-life costs
- Filters sit low and close to the face, providing excellent balance and weight distribution
- Side mounted filter
- Polycarbonate visor
- Compatible with PF-600E-ASB PAPR
- Complies with AS/NZS 1716:2012 Respiratory Protective Devices



For use with the range of 3M DT-Series Filters & Cartridges



Scan or Click for Tech Data Sheet

## Compatible with:



PF-600E-ASB

Refer to Powered Air Purifying Respirator and Airline Sections for more information

## Accessories

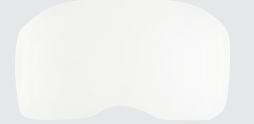

FF-600-926



FF-600-20

SAP ID	Legacy ID	Availability		Model #	Description
		AUS	NZ		
7100236942	UU010979498	•	•	FF-601	3M™ Reusable Full Face Mask FF-601-S, Small, 4 ea/Case
7100236941	UU010979480	•	•	FF-602	3M™ Reusable Full Face Mask FF-602-M, Medium, 4 ea/Case
7100236885	UU010979332	•	•	FF-603	3M™ Reusable Full Face Mask FF-603-L, Large, 4 ea/Case
7100236084	UU010979506	•	•	FF-600-926	3M™ Visor Peel Offs FF-600-926, 20 ea/Case
7100236821	UU010979514	•	•	FF-600-20	3M™ Spectacle Kit FF-600-20, 4 ea/Case

## Full Facepiece Respirator Accessories

Storage bags for Full Face Respirators.

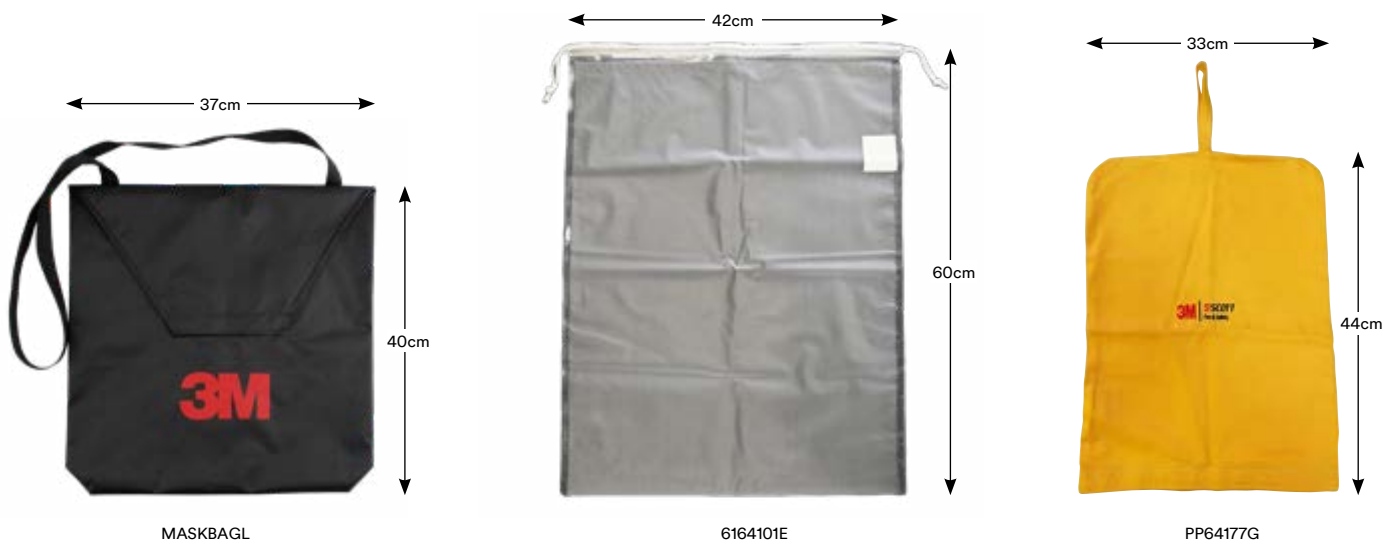

SAP ID	Legacy ID	Availability		Model #	Description
		AUS	NZ		
7012919206	AT010655788	•		MASKBAGL	3M™ Canvas Bag for Half/Full Face Mask Filter, 37×40cm, 100/Case
7012920848	AT010687468	•		6164101E	3M™ Storage Poly Bag 6164101E, PVC, Clear PVC 56×42cm
7012918517	AT010655762	•		PP64177G	3M™ Scott™ Vision 3 Bag Facemask PP64177G, BA 33×44cm

# Reusable Respirators 3M™ DT-Series Filters & Cartridges

## 3M™ DT-Series Filters and Cartridges

### Particulate Protection Only



DT-1135E P3

**DT-1135E**

QR-RR-58

Scan or Click for Tech Data Sheet

### Gas & Vapour Protection Only



DT-4001E A2

**DT-4001E**

QR-RR-59

Scan or Click for Tech Data Sheet

### Combined Particulate + Gas & Vapour Protection



DT-4031E A2P3

**DT-4031E**

QR-RR-60

Scan or Click for Tech Data Sheet



DT-4035E A2B2P3

**DT-4035E**

QR-RR-61

Scan or Click for Tech Data Sheet



DT-4036E A2B2E1P3

**DT-4036E**

QR-RR-62

Scan or Click for Tech Data Sheet



DT-4047E AXP3

**DT-4047E**

QR-RR-63

Scan or Click for Tech Data Sheet



DT-4045E A2B2E2K2-P3

**DT-4045E**

QR-RR-64

Scan or Click for Tech Data Sheet



DT-4046E A2B2E2K2HgP3

**DT-4046E**

QR-RR-65

Scan or Click for Tech Data Sheet

## Suitable facepieces for DT-Series Filters and Cartridges



FF-300

Export controlled product. Document required to be signed upon purchase.



FF-600

FF-600F

## Pre-Filters and Accessories



SS-6601

SS-6600



SS-6607



SS-6603

SAP ID	Legacy ID	Availability		Model #	Description
		AUS	NZ		
7100260622	UU011502539	•	•	DT-1135E	3M™ Particulate Filter PF10 P3 DT-1135E, 10 ea/Case
7100264834	UU011546916	•	•	DT-4001E	3M™ Gas & Vapour Filter GF22 A2 DT-4001E, 10 ea/Case
7100260646	UU011502554	•	•	DT-4031E	3M™ Combination Filter DT-4031E, CF22 A2P3, 10 ea/Case
7100260644	UU011502570	•	•	DT-4035E	3M™ Combination Filter DT-4035E, CF22 A2B2P3, 10 ea/Case
7100260627	UU011507462	•	•	DT-4036E	3M™ Combination Filter CF22 A2B2E1P3 DT-4036E, 10 Each/Case
7100260628	UU011502596	•	•	DT-4045E	3M™ Combination Filter DT-4045E, CF32 A2B2E2K2P3, 10 ea/Case
7100260645	UU011502588	•	•	DT-4046E	3M™ Combination Filter CF32 A2B2E2K2HgP3 DT-4046E, 10 Each/Case
7100264837	UU011546965	•	•	DT-4047E	3M™ Combination Filter CF32 AXP3 DT-4047E, 10 ea/Case
7100236853	UU010979753	•	•	SS-6601/SC-6601	3M™ Prefilter and Prefilter Holder SS-6601, 5 ea/Case
7100236854	UU010979779	•	•	SS-6600/SC-6600	3M™ Prefilter SS-6600, 100 ea/Case
7100237883	XP100544442	•	•	SS-6607/SC-6607	3M™ Filter Cover SS-6607, 10 ea/Case
7012917340	XP100218930	•	•	SS-6603 (5052694)	3M™ Scott™ Filter Shower Cover SS_6603/5052694

# Reusable Respirators 3M™ DT-Series Parts & Accessories

## 3M Reusable Respirator Full Face FF-300 Spare Parts



SAP ID	Legacy ID	Availability		Model #	Description
		AUS	NZ		
7012869296	XP100546108	•	•	FF-300-04/12692	3M™ Scott™ Head Harness for FF-300, 012692/FF-300-04
7100265067	UU011565973	•	•	FF-300-05/12691	3M™ Scott™ Nose Cup Assembly for FF-300, 012691/FF-300-05
7012917588	XP100547296	•	•	FF-300-06/12794	3M™ Scott™ Front Cover and Screws for FF-300, 012794/FF-300-06
7012917433	XP100544087	•	•	FF-300-07/12687	3M™ Scott™ Speech Diaphragm for FF-300, 12687/FF-300-07
7012917538	XP100547189	•	•	FF-300-08/12658	3M™ Scott™ Spark Guard for Speech Diaphragm for FF-300, 012658/FF-300-08, for
7012917548	XP100547197	•	•	FF-300-08/12659	3M™ Scott™ Spark Guard for Exhale Valve for FF-300, 012659/FF-300-08 1 ea/Case
7012917473	XP100547247	•	•	FF-300-09/12693	3M™ Scott™ Visor Frame Assembly for FF-300, FF-300-09
7012888686	XP100544103	•	•	FF-300-11/12689	3M™ Scott™ Valve Seat for FF-300, 012689/FF-300-11 1 ea/Case
7100266032	UU011589122	•	•	FF-300-12/12690	3M™ Scott™ Inhalation and Exhalation Valve Set for FF-300, FF-300-12
7012912362	XP100544160	•	•	FF-300-20/12790	3M™ Scott™ Prescription Spectacle Frame for FF-300, 012790/FF-300-20
7012917708	XP100544095	•	•	FF-300-21/12688	3M™ Scott™ Solid Exhalation Valve Cover for FF-300, 012688/FF-300-21
7012888687	XP100544129	•	•	FF-300-41/12694	3M™ Scott™ Buckle Set for harness for FF-300, FF-300-41
7012890809	XP100544137	•	•	FF-300-925/12695	3M™ Scott™ Polycarbonate Visor FF-300, 012695/FF-300-925 1 ea/Case
7012623323	XP100544145	•	•	FF-300-926/12698	3M™ Scott™ Lens Covers for FF-300, 012698/FF-300-926 10/Pack
7012871093	XP100544186	•	•	FF-300-927/12795	3M™ Scott™ Hard Coated Polycarbonate Visor for FF-300, 012795/FF-300-927 5 ea/Case
7100265981	XP100547254	•	•	SC-3604	3M™ Neck Strap Assembly SC-3604, 1 ea/Case
7100265515	UU011580360	•	•	SC-6611/RXFTA/STAN	3M™ Scott™ Fit Test Adapter SC-6611 DIN40, QNFT-CNC 1 ea/Case

Please note not all parts and accessories are stocked or active in our system. Please contact 3M sales rep or customers service for further clarification.

# Reusable Respirators 3M™ DT-Series Parts & Accessories

## 3M Reusable Respirator Full Face FF-600 Spare Parts

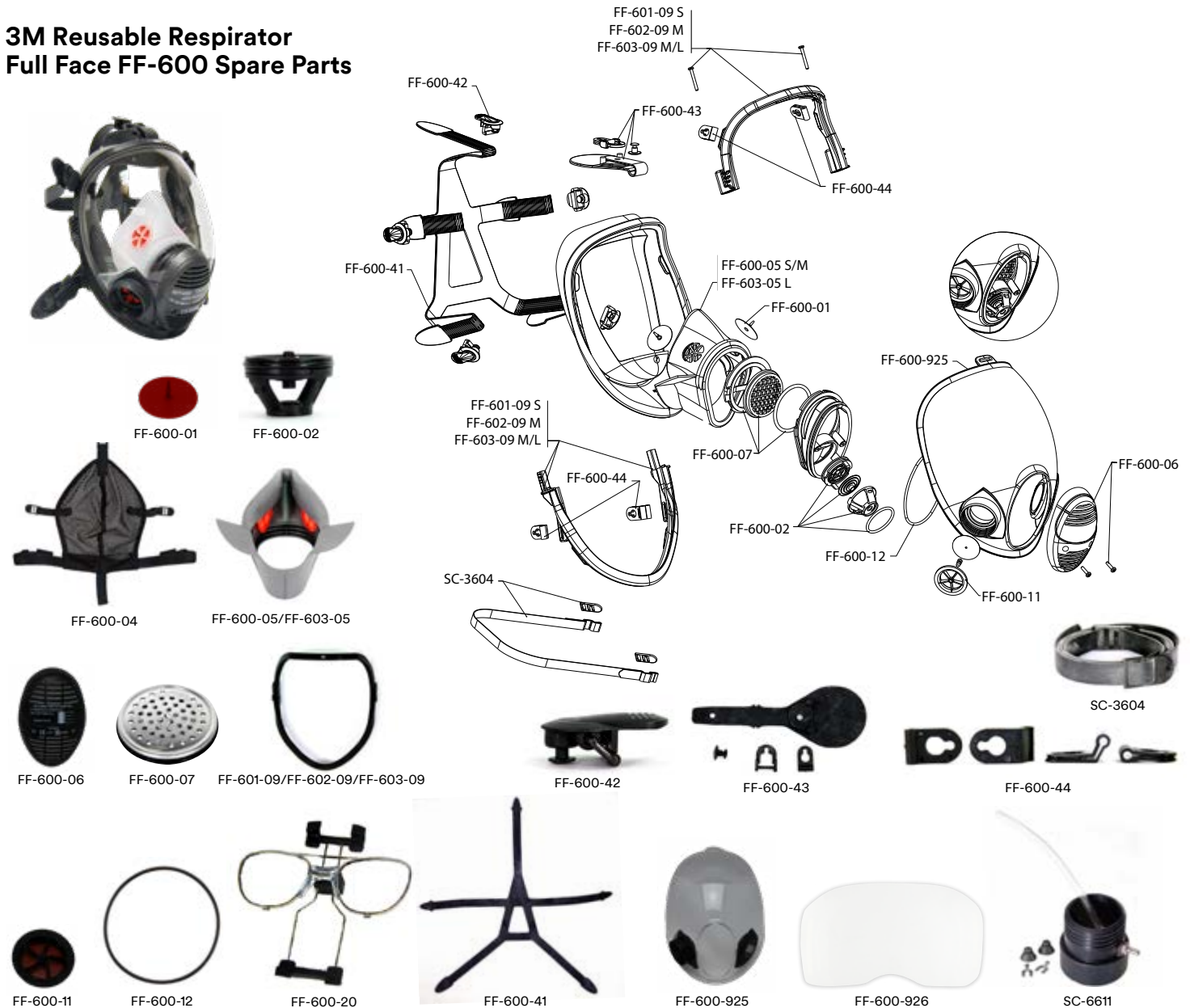

SAP ID	Legacy ID	Availability		Model #	Description
		AUS	NZ		
7100265031	UU011565155	•	•	FF-600-01/7111429	3M™ Scott™ Inhalation Valve for FF-600/FF-600F, FF-600-01, 50 ea/Case
7100266046	UU011589072	•	•	FF-600-02/2015853	3M™ Scott™ Exhalation Valve Assembly for FF-600, FF-600-02 5 ea/Case
7100236819	UU010979548	•	•	FF-600-04/1033400	3M™ Scott™ Polynet Head Harness FF-600/FF-600F, FF-600-04
7100265027	UU011544549	•	•	FF-600-05/7171289	3M™ Scott™ Nose Cup Assembly Small/Medium for FF-600/FF-600F, FF-600-05 1 ea/Case
7100265233	UU011544556	•	•	FF-603-05	3M™ Scott™ Nose Cup Assembly Large for FF-600/FF-600F, FF-603-05, 1 ea/Case
7012917485	XP100065596	•	•	FF-600-06/1033085	3M™ Scott™ Front Fitting For for FF-600, 1033085/FF-600-06
7100266047	UU011589130	•	•	FF-600-07/2003437	3M™ Scott™ Speech Diaphragm Assembly for FF-600/FF-600F, FF-600-07, 10 ea/Case
7100265057	UU011565809	•	•	FF-601-09	3M™ Scott™ Visor Frame Assembly Small for FF-600/FF-600F, FF-601-09
7100265059	UU011565775	•	•	FF-602-09	3M™ Scott™ Visor Frame Assembly Medium for FF-600/FF-600F, FF-602-09
7100265047	UU011565759	•	•	FF-603-09/7171089	3M™ Scott™ Visor Frame Assembly Medium/Large for FF-600/FF-600F, FF-603-09
7100265046	UU011565742	•	•	FF-600-11	3M™ Scott™ Inhalation Valve Seat Set for FF-600/FF-600F, FF-600-11
7100236822	UU010979126	•	•	FF-600-12/1027929	3M™ Scott™ Front Fitting Gasket for FF-600/FF-600F, FF-600-12, 20 ea/Case
7100236821	UU010979514	•	•	FF-600-20/2015082	3M™ Scott™ Spectacle Kit for FF-600/FF-600F, FF-600-20 4 ea/Case
7100265053	UU011565734	•	•	FF-600-41/7170489	3M™ Scott™ Head Harness Assembly for FF-600/FF-600F, FF-600-41 2 ea/Case
7100265077	UU011566047	•	•	FF-600-42/7170789	3M™ Scott™ Buckle And Roller Pack for FF-600/FF-600F, FF-600-42
7100265241	UU011565767	•	•	FF-600-43/7175189	3M™ Scott™ Head Harness Clips for FF-600/FF-600F, FF-600-43
7012917510	XP100065638	•	•	FF-600-44/1033128	3M™ Scott™ Hinge Pack For FF-600/FF-600F, 1033128/FF-600-44, 5 Pack/Case
7100236997	UU011589148	•	•	FF-600-925/2009017	3M™ Scott™ Standard Diaphragm Visor for FF-600, FF-600-925 4 ea/Case
7100236084	XP100545068	•	•	FF-600-926/VCP1000	3M™ Scott™ Visor Peel Offs for FF-600/FF-600F, FF-600-926 20 ea/Case
7100265981	UU011600176	•	•	SC-3604	3M™ Neck Strap Assembly SC-3604, 1 ea/Case
7100265515	UU011580360	•	•	SC-6611/RXFTA/STAN	3M™ Fit Test Adapter SC-6611 DIN40, QNFT-CNC 1 ea/Case

Please note not all parts and accessories are stocked or active in our system. Please contact 3M sales rep or customers service for further clarification.

# Reusable Respirators 3M™ DT-Series Parts & Accessories

## 3M Reusable Respirator Full Face FF-600F Spare Parts

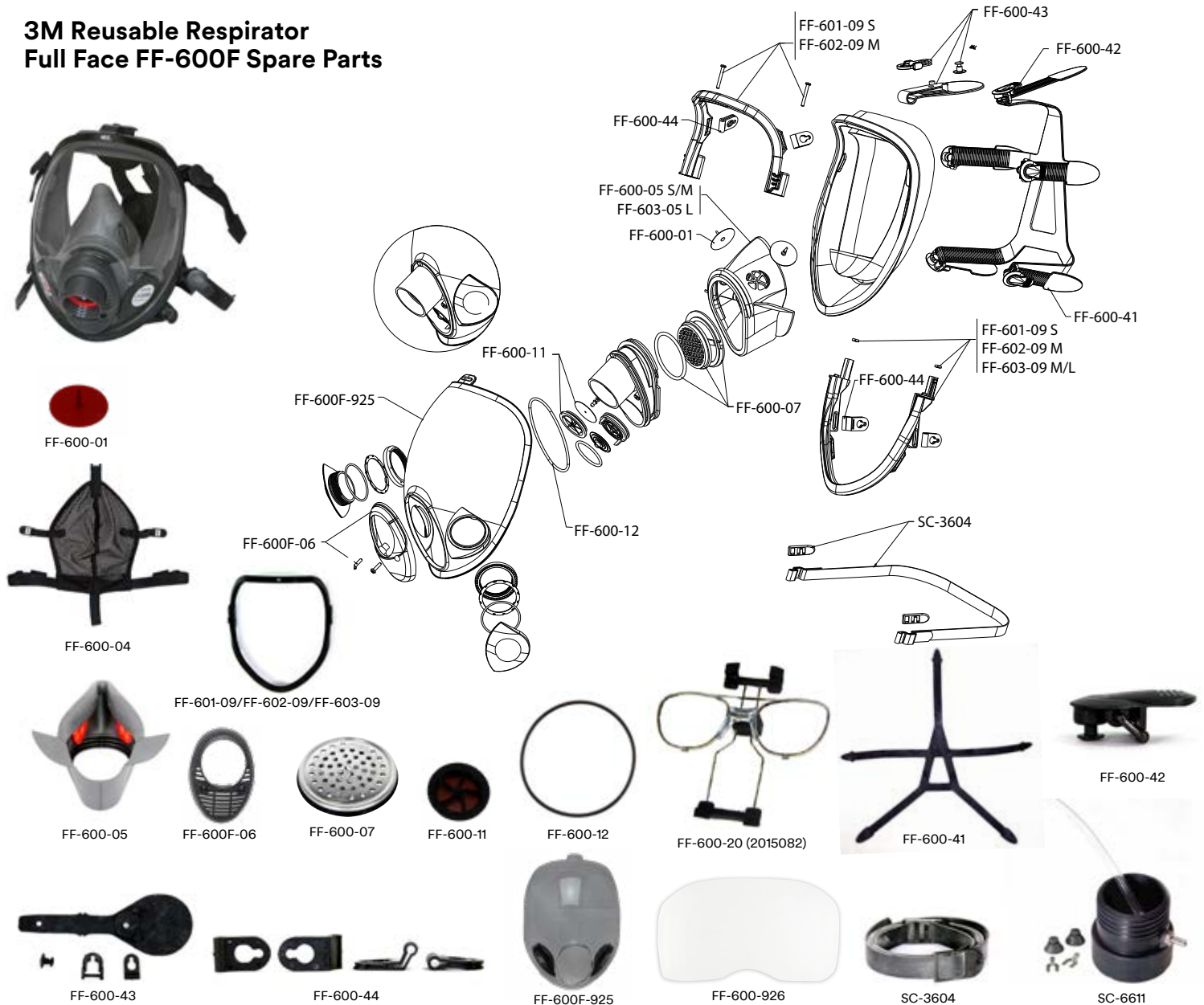

SAP ID	Legacy ID	Availability		Model #	Description
		AUS	NZ		
700265031	UU011565155	•	•	FF-600-01/7111429	3M™ Inhalation Valve FF-600-01, for FF-600/FF-600F 50 ea/Case
7100236819	UU010979548	•	•	FF-600-04/1033400	3M™ Scott™ Polynet Head Harness FF-600/FF-600F, FF-600-04
7100265027	UU011544549	•	•	FF-600-05/7171289	3M™ Nose Cup Assembly FF-600-05, Small/Medium, for FF-600/FF-600F 1 ea/Case
7100265233	UU011544556	•	•	FF-603-05	3M™ Nose Cup Assembly, FF-603-05, Large, for FF-600/FF-600F 1 ea/Case
7100265058	UU011565791	•	•	FF-600F-06/2007215	3M™ Scott™ Front Cover for FF-600F, FF-600F-06
7100266047	UU011589130	•	•	FF-600-07/2003437	3M™ Speech Diaphragm Assembly FF-600-07, for FF-600/FF-600F 10 ea/Case
7100265057	UU011565809	•	•	FF-601-09	3M™ Scott™ Visor Frame Assembly Small for FF-600/FF-600F, FF-601-09
7100265059	UU011565775	•	•	FF-602-09	3M™ Scott™ Visor Frame Assembly Medium for FF-600/FF-600F, FF-602-09
7100265047	UU011565759	•	•	FF-603-09/7171089	3M™ Scott™ Visor Frame Assembly Medium/Large for FF-600/FF-600F, FF-603-09
7100265046	UU011565742	•	•	FF-600-11	3M™ Scott™ Inhalation Valve Seat Set for FF-600/FF-600F, FF-600-11
7100236822	UU010979126	•	•	FF-600-12/1027929	3M™ Front Fitting Gasket FF-600-12, for FF-600/FF-600F 20 ea/Case
7100236821	UU010979514	•	•	FF-600-20/2015082	3M™ Spectacle Kit FF-600-20, for FF-600/FF-600F 4 ea/Case
7100265053	UU011565734	•	•	FF-600-41/7170489	3M™ Head Harness Assembly FF-600-41, for FF-600/FF-600F 2 ea/Case
7100265077	UU011566047	•	•	FF-600-42/7170789	3M™ Scott™ Buckle And Roller Pack for FF-600/FF-600F, FF-600-42
7100265241	UU011565767	•	•	FF-600-43/7175189	3M™ Scott™ Head Harness Clips for FF-600/FF-600F, FF-600-43
7012917510	XP100065638	•	•	FF-600-44/1033128	3M™ Scott™ Hinge Pack 3 + 2 Vision 3 Mask FF-600-44/1033128, For FF-600/FF-600F 5 Pack/Case
7100266117	UU011589148	•	•	FF-600F-925 /2016422	3M™ Scott™ Standard Visor for FF-600F, FF-600F-925 5 ea/Case
7100236084	UU010979506	•	•	FF-600-926/VCP1000	3M™ Visor Peel Offs FF-600-926, for FF-600/FF-600F 20 ea/Case
7100265981	XP100065687	•	•	SC-3604	3M™ Neck Strap Assembly SC-3604, 1 ea/Case
7100265515	UU011580360	•	•	SC-6611/RXFTA/STAN	3M™ Scott™ Fit Test Adapter SC-6611 DIN40, QNFT-CNC 1 ea/Case

Please note not all parts and accessories are stocked or active in our system. Please contact 3M sales rep or customers service for further clarification.

# Reusable Respirators

## 3M™ Maintenance Free Reusable Respirators, 4000+ Series

- Disposable, maintenance-free half facepiece respirator
- Twin inhalation valves and large, bonded carbon filters with permanently attached particulate filters
- Integrated filters mean it's ready to use and maintenance free
- Centrally-positioned exhalation valve helps reduce heat and moisture build-up in hot and humid conditions
- Enhanced valve assembly helps to reduce exhalation breathing resistance for improved breathing comfort
- Includes a resealable bag for hygienic storage and transportation
- Complies with AS/NZS 1716:2012 Respiratory Protective Devices



QR-RR-66

Scan or Click for Brochure



QR-RR-67

Scan or Click for Fitting Poster



4251+ A1P2

4255+ A2P2

4277+ A1B1E1P2

4279+ A1B1E1K1P2

SAP ID	Legacy ID	Availability		Model #	Description
		AUS	NZ		
7100113098	UU008107219	•		4251+	3M™ Maintenance Free Half Face Respirator 4251+, A1P2, 10 ea/Case
7100113101	UU008107474	•		4255+	3M™ Maintenance Free Half Face Respirator 4255+, A2P2, 10 ea/Case
7100113102	UU008107490	•	•	4277+	3M™ Maintenance Free Half Face Respirator 4277+, A1B1E1P2, 1/Bag
7100113103	UU008107508	•		4279+	3M™ Maintenance Free Half Face Respirator 4279+, A1B1E1K1P2, 10 ea/Case

## 3M™ Respirator Cleaning Wipe 504

- Moist towelettes clean dirt and perspiration off facepiece respirators
- Individually packaged and sealed
- Disposable, one-time-use for convenience
- Convenient for respirator hygiene and sanitary protection between uses
- Towelettes come 100 per box



QR-RR-68

Scan or Click for Tech Data Sheet

SAP ID	Legacy ID	Availability		Model #	Description
		AUS	NZ		
7000001938	AT010587411 (AUS) 70070317139 (NZ)	•	•	504	3M™ Respirator Cleaning Wipe 504, 100 Each/Pack, 500 Each/Case



## Inspection

- Respirator must be inspected before each use; repair or dispose of if damaged or defective
- Check the faceseal for cracks, tears and dirt
- Examine the inhalation valves for distortion, cracking or tearing
- Check that the headstraps are intact and have good elasticity
- Examine all plastic parts and gaskets for cracking and fatigue
- Examine exhalation valve for cracks, tear, distortion etc; replace valve if necessary
- Check lens for signs of cracking or damage, replace if necessary
- Do not enter a contaminated area with damaged or defective parts



## Cleaning

- Cleaning is recommended after each use
- Remove cartridges, filters and/or breathing tubes
- Center adaptor, lens and faceseal can be removed if necessary
- Clean facepiece by immersing in warm, cleaning solution
- Scrub with a soft bristle brush until clean
- Water temperature must not exceed 49° C (120° F)
- Disinfect facepiece by soaking in a solution of quaternary ammonia disinfectant, sodium hypochloride or household bleach
- Rinse in fresh, warm water and air dry in a non-contaminated atmosphere
- Cleaned and dried respirator should be placed in a clean bag and stored away from the contaminated area when not in use
- 3M respirator 504 cleaning wipes can be used for interim cleaning but must not be the only cleaning method in place





**3M Australia Pty Ltd**

Bld A, 1 Rivett Road  
North Ryde, NSW 2113  
Customer Services: 1300 363 565  
Email: [3msupport.safety.au@mmm.com](mailto:3msupport.safety.au@mmm.com)  
[3M.com.au/ppesafety](http://3M.com.au/ppesafety)

**3M New Zealand Limited**

94 Apollo Drive  
Rosedale, Auckland 0632  
Customer Services: 0800 252 627  
Email: [3msupport.safety.nz@mmm.com](mailto:3msupport.safety.nz@mmm.com)  
[3M.com/nz/ppesafety](http://3M.com/nz/ppesafety)