



Science.
Applied to Life.™



Helping enable the next generation of electronics.

3M™ EMI/RFI Management Solutions

Don't let unwanted frequencies interfere with electronics components performance.

Why is minimizing EMI/RFI important?

When the amount of noise (EMI) rises higher than the signal's strength, resulting in a low signal-to-noise ratio (SNR), it can degrade electronic performance. This results in errors, data loss, delayed or incorrect readings, or even temporary shutdowns. Which is why it is critical to prevent EMI as much as possible.

3M™ EMI/RFI Management Solutions will help you:













- » Minimize EMI noise and crosstalk
- » Improve signal integrity
- » Enable high performing and reliable materials
- » Be more cost-effective
- » Achieve quick and easy application with peel and stick solutions

Generated by electronic devices, communications signals, electromagnetic frequencies and static electricity, Electromagnetic Interference (EMI) – also known as Radio Frequency Interference (RFI) – is an electronic emission that interferes with the performance of electronic components, RF systems and other critical equipment.

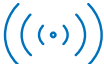



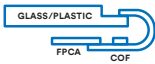

Help manage EMI with 3M™ EMI/RFI Solutions

Help protect your systems and achieve efficient and reliable operations with solutions from 3M. We bring decades of expertise in EMI/RFI management and materials science to help you solve complex and dynamic design challenges. Our EMI/RFI management solutions are known for helping boost signal-to-noise ratios in industrial electronics, improving antenna signal integrity, and even grounding displays for connected and smart products.

EMI Shielding and Grounding Applications

 Flex circuit to flex circuit interconnection	 Camera module grounding	 Electrostatic discharge (ESD)	 Shield can lid	 PCB/flex/chassis grounding
 Medium pitch flexible circuits and PCBs	 PIM management	 Sensor grounding	 EMI shield and gasket attachment	 Bond line gap shielding
 FPC grounding	 Shielding display wrap	 Display chip on flex		

EMI Absorbing Applications

 Cable wrapping/attachment	 Attached to noise (traces, IC's, reflective enclosure surface)	 Attached to metal surface (reduce emitting EMI noise)
 Near field communication	 Attached to semicon chip/micro-processors	 Insert between module (compartment)

3M™ Electrically Conductive Tapes Selection Criteria

Selecting a 3M™ Electrically Conductive Tape for grounding, shielding, and attachment includes identifying several application requirements. For instance, the selection process could consider the following items, among others:

- 1 - Contact R target
- 2 - Contact surface type
- 3 - Adhesion level desired
- 4 - Bond line thickness
- 5 - XYZ or Z conductivity path
- 6 - Operating temperature range and environmental conditions
- 7 - EMI shielding in bond line “gap/slit” for higher frequencies
- 8 - Surface contact area for adhesion
- 9 - Assembly pressure, temperature and time

Meet your “go-to” materials

3M created the EMI/RFI Management Solutions Go-To Material List (GTML) to provide fast and reliable service on our go-to materials. The GTML includes materials that cover most applications and provide differentiated solutions for various EMI design challenges.

Make these materials the first, go-to options for EMI challenges, supplemented by a broader line of 3M EMI/RFI materials for niche applications.

★ = Indicates which material and thickness are part of the GTML.

The “**Good**-**Better**-**Best**” rankings are based on the 3M Test Method and tape performance in a nominal application.

**This information is based on tests performed at 3M laboratory facilities. While we believe that these test results are reliable, your results may vary due to differences in test conditions, your facility/lab environment, or the other conditions within your control. This information is intended for industrial/occupational use by persons with the knowledge and technical skills to analyze, handle and use such information. It is supplemental only and is not intended to replace the detailed information found in written 3M product literature. For additional information, including important safety and warranty information, regarding 3M EMSD products, please refer to the data sheets, instruction and/or installation manuals.*

Product	Typical contact resistance (R ohms Ω)	EMI shielding in bond line gap/slit	Flex to PCB contact resistance (R ohms Ω)	Peel strength (24 hr/RT)	Workability	Thermal conductivity/resistance (W/mK or C/W)
3M™ Electrically Conductive Double-Sided Tapes						
3M™ Electrically Conductive Adhesive Transfer Tapes						
★ 3M tape 9703	Good	N/A	Better	Good	Good	Good
3M tape 9709SL	Better	Better	Best	Good	Better	Best
3M tape 9712	Good	Good	Good	Better	Good	Good
3M tape 9713	Better	Good	Good	Better	Good	Good
3M™ Electrically Conductive Double-Coated Tapes						
★ 3M tape 5113DFT	Best	Best	Best	Better	Best	Better
★ 3M tape 9772	Best	Best	Good	Good	Best	Best
3M tape 9711S	Best	Better	Best	Best	Best	Better
3M tape 9723	Good	Good	Better	Best	Good	Good
3M™ Electrically Conductive Single-Sided Tapes						
★ 3M tape 5113SFT	Better	Good	Better	Good	Better	Good
★ 3M tape 3304BC-S	Best	Best	Best	Better	Better	Good
★ 3M tape 1020BC	Best	Better	Best	Good	Best	Better
3M tape 1050TC	Best	Better	Best	Good	Better	Best
3M tape CEF-3BV	Good	Good	Good	Better	Better	Good

- ▶ **Typical contact resistance** - Gold flex bonded to stainless steel (SS). “Best” results relate to a lower contact R potential on SS Contact R can vary with SS type tested. Lower contact resistance can allow for improved EMI shielding of a design.
- ▶ **EMI Shielding in Bond Line “Gap/Slit”** - Best = High dB EMI Shielding. Inherent EMI shielding at the bond line provides significantly reduced crosstalk, stray EMI, noise in circuit, antennae effects, FPC susceptibility and spurious emissions.
- ▶ **Flex to PCB Contact Resistance** - Potential to improve contact R grounding locations via improved surface conformability and XYZ conductive potential with a 3M electrically conductive tape or film vs. a generic Z-axis only conductive PSA.
- ▶ **Peel Strength** - Adhesion to SS type substrate/3M Test Method/24 hour room temp dwell.
- ▶ **Workability** - Ease of Rework based on a standard set of high surface energy substrates. The tape design can affect rework based on adhesive type and conductive filler type.
- ▶ **Thermal Conductivity/Thermal Resistance** - Effective Thermal Resistance and Thermal Conductivity vs. a generic PSA without conductive fillers. Important for thermal connection performance between substrates.

3M™ Electrically Conductive Single-Sided Tapes

3M™ Electrically Conductive Single-Sided Tapes offer XYZ-axis conductivity in a variety of conductive adhesives, carriers, and fillers to provide enhanced EMI performance where you need it (flexibility, conformability, adhesion, temperature range, etc.). These tapes are available in multiple thicknesses and provide EMI/RFI shielding and/or grounding across multiple frequencies.

Features and benefits

- » XYZ-axis conductivity
- » Conformability and edge conformance
- » Excellent EMI/ESD and electrical performance over time
- » Overlap resistance and electrical contact on small areas and bond lines
- » High adhesion for reliable contact to various substrates
- » Great handling & workability
- » Thin product constructions for applications with less Z-space

Product construction

3M Fabric Tapes

5113SFT Series,
CEF-3BV

Conductive fabric carrier

Conductive adhesive

Release liner

3M Foil Tapes, PSA with conductive nonwoven

3304BC-S

Top layer (carbon black)

Copper foil

Conductive Ni/Cu nonwoven acrylic PSA

Release liner

3M Foil Tapes, PSA with conductive fillers

1050TC Series,
1020BC Series*

Conductive layer (black)
*This layer is ONLY used in 1020BC Series

Copper foil

Conductive acrylic PSA

Release liner

Applications



Shield can lid



Shielding display wrap



PIM management



Sensor grounding

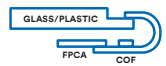

Display chip on flex

3M product number	Thickness mil (mm)	Conductive filler type and tape format	Adhesive type	Liner type	Electrical resistance through Z-axis Ω (3M ETM-12)	Electrical resistance through XY-axis Ω (3M ETM-7)	Adhesion to SUS (gf/inch)	Unique features and benefits
★ 5113SFT	2.0 (0.05)	Fabric backing C-SFT	Polyolefin	PET release liner	<0.03 Ω	<0.1 Ω	1500 (ASTM D3330)	<ul style="list-style-type: none"> » XYZ-axis conductivity through adhesive » Excellent electrical contact to small size areas » Resists moisture to maintain the products' integrity enabling a 4-year shelf-life » Excellent EMI shielding in bond line gap » Expands long-term operating temperature range to 105°C
★ 3304BC-S	1.8 (0.045)	Ni/Cu nonwoven foil backing	Acrylic	Silicone coated PET film	0.05 Ω	0.1 Ω	1300 (ASTM D1000)	<ul style="list-style-type: none"> » Scratch-resistant black copper foil » Excellent edge conformability » High shielding performances
1050TC	0.9 (0.023)	Foil backing C-SCT		PET release liner	N/A	0.015 Ω	1200 (ASTM D1000)	<ul style="list-style-type: none"> » XYZ-conductivity » Conformable, quick bonding » Copper foil backing
★ 1020BC	1.0 (0.025)	Foil backing C-SCT						<ul style="list-style-type: none"> » XYZ-conductivity » Excellent EMI shielding performance » Excellent conformability and quick bonding » Reliable contacts to small size grounding areas » High adhesion and good grounding performance to many surface types » Black conductive coating
CEF-3BV	2.8 (0.07)	Black fabric backing C-SFT						Paper liner

★ = Indicates which material and thickness are part of the GTML. The above technical information and data should be considered representative or typical only and should not be used for specification purposes. Contact your 3M Technical Representative for details.

3M™ Electrically Conductive Double-Coated Tapes

3M™ Electrically Conductive Double-Coated Tapes feature XYZ-axis conductivity and have a layer of adhesive coated on both sides of the carrier and are easier to die-cut and handle than adhesive transfer tapes (no carrier). They come in a variety of conductive adhesives, carriers and fillers to provide enhanced EMI performance where you need it (flexibility, conformability, adhesion, temperature resistance). The tapes provide a broad spectrum of performance in a variety of applications.

Features and benefits

- » XYZ-axis conductivity
- » A broad range of thicknesses
- » Electrical contact to small contact areas and bond lines
- » Excellent grounding performance over time
- » Great EMI shielding in bond line gap
- » Multiple levels of adhesion, conformability, and flexibility
- » Adhesion to a variety of substrates and surfaces
- » Great handling & workability

Product construction

3M Woven Fabric Tapes

5113DFT Series,
9711S Series

Transparent PET release liner

Conductive adhesive

Conductive fabric

Conductive adhesive

Release liner

3M High Performing Foil Tapes

9772 Series

Release liner

Conductive acrylic adhesive

Copper foil

Conductive acrylic adhesive

Release liner

3M Nonwoven Tapes

9723

Release liner

Conductive adhesive

Conductive nonwoven

Conductive adhesive

Release liner

Applications



Flex circuit
to flex circuit
interconnection



Sensor
grounding



Electrostatic
discharge
(ESD)



EMI shield
and gasket
attachment



PCB/flex/
chassis
grounding



Flexible
circuits
and PCBs



FPC
grounding

3M product number	Thickness mil (mm)	Conductive filler type and tape format	Adhesive type	Liner type	Electrical resistance through Z-axis Ω (3M ETM-12)	Electrical resistance through XY-axis Ω (3M ETM-7)	Adhesion to SUS (gf/inch)	Unique features and benefits
★ 5113DFT	2.0 (0.05)	Fabric backing	Polyolefin	PET release liner	0.03 Ω	0.1 Ω	1500 (ASTM D3330)	<ul style="list-style-type: none"> » XYZ-axis conductivity through adhesive » Excellent electrical contact to small size areas » Resists moisture to maintain the products' integrity enabling a 4-year shelf-life » Excellent EMI shielding in bond line gap » Expands long-term operating temperature range to 105°C
★ 9772	2 (0.05)	Foil backing	Acrylic		N/A	0.015 Ω	1000 (ASTM D1000)	<ul style="list-style-type: none"> » Good EMI shielding in the bondline gap » Best XY-axis electrical resistance in double-sided conductive PSAs » Low PIM
9711S	2 (0.05) 4 (0.1)	Ni/Cu woven			0.05 Ω	0.15 Ω	1800 (ASTM D1000)	<ul style="list-style-type: none"> » Low contact resistance » High adhesion » Excellent conformability » Quick bonding » Wide range of thickness options
9723	2.4 (0.06)	Ni/Cu nonwoven			0.15	0.30	1500 (ASTM D3330)	<ul style="list-style-type: none"> » Good adhesion to most metal surfaces » Low electrical resistance that is stable over time » Dual PET Liner

★ = Indicates which material and thickness are part of the GTML

The above technical information and data should be considered representative or typical only and should not be used for specification purposes. Contact your 3M Technical Representative for details.

3M™ Electrically Conductive Adhesive Transfer Tapes

3M™ Electrically Conductive Adhesive Transfer Tapes deliver a broad spectrum of performance, including high EMI shielding in the bond line gap for high-frequency attenuation, stable contact resistance for reliable electrical conductivity, and conformability for creating a strong bond. Multiple thicknesses, conductive fillers, and particle designs are available.

Features and benefits

- » XYZ-axis conductivity or Z-axis based conductivity
- » A broad range of thicknesses
- » Electrical contact to small contact areas and bond lines
- » Excellent grounding performance over time
- » Great EMI shielding in bond line gap
- » Multiple levels of adhesion, conformability, and flexibility
- » Adhesion to a variety of substrates and surfaces
- » Great handling & workability

Product construction

3M Conductive Tapes with silver filler

9703,
9709SL

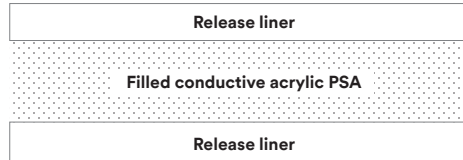

3M Conductive Tapes with conductive fibers

9712,
9713

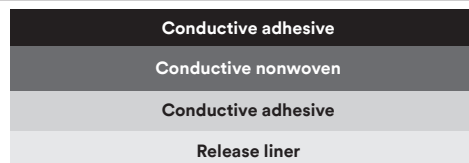

Applications



Flex circuit to flex circuit interconnection



Camera module grounding



Electrostatic discharge (ESD)



EMI shield and gasket attachment



PCB/flex/chassis grounding



Medium pitch flexible circuits and PCBs



FPC grounding



Sensor grounding



Bond line gap shielding

3M product number	Thickness mil (mm)	Conductive filler type	Adhesive type	Liner type	Electrical resistance through Z-axis Ω (3M ETM-12)	Electrical resistance through XY-axis Ω (3M ETM-7)	Adhesion to SUS (gf/inch)	Unique features and benefits
★ 9703	2 (0.05)	Silver particles	Acrylic	Silicone treated PCK	0.01 Ω	N/A	907 (ASTM D1000)	<ul style="list-style-type: none"> » Anisotropic Z-axis electrical conductivity » Low outgassing » Pressure-sensitive adhesive (PSA) tack properties » Thermal curing not required
9709SL				PCK release liner, PET release liner	0.06 Ω	40 Ω	825 (ASTM D1000)	<ul style="list-style-type: none"> » Standard adhesion » Good EMI shielding in bond line gap » High frequency » Thermal conductivity » Excellent conformability » Low liner release (SL)
9712	5 (0.127)	Carbon nonwoven		Silicone treated PCK	13 Ω	50-70 Ω	1500 (ASTM D3330)	<ul style="list-style-type: none"> » Standard adhesion » No nickel » Non-magnetic material » Nonwoven conductive scrim
9713	3.5 (0.089)	Ni/Cu nonwoven			1.7 Ω	5 Ω		<ul style="list-style-type: none"> » Standard adhesion » Isotropic XYZ-axis electrical connectivity » Uses nickel plated carbon scrim » Good contact with both hard and soft surfaces » Excellent die-cutting and converting capabilities

3M™ Electrically Conductive Gasket Tapes

3M™ Electrically Conductive Gasket Tapes are compressible electrically conductive open-cell urethane foam gaskets with single or double-coated conductive adhesives and an additional internal copper foil layer for shielding gasket (3M™ Gasket Tape™ MSG7000SDX Serie). These XYZ-axis conductive gaskets feature excellent conductivity to ground two surfaces with a wide gap and/or EMI shielding.

Features and benefits

- » Multiple thickness options for a range of gap sizes
- » Grounding connection under compression
- » Reworkable during assembly
- » Single or double-coated conductive adhesive
- » Conductive foam laminated with fabric allows compression for very wide gaps (3M tape MSG7000SDX Serie)
- » High adhesion conductive acrylic pressure sensitive
- » Removable liner for easy handling and die-cutting
- » Halogen-free products available

Product construction

3M Electrically Conductive Foam Gasket

MSG7000SDX Series
coming soon

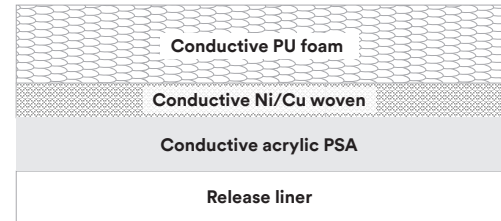

3M Electrically Conductive Foaming PSA

ECG7000H Series,
ECG8000H Series*

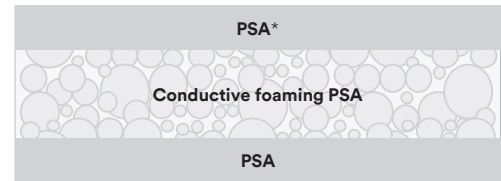

*This layer is ONLY used in ECG8000H Series

Applications



Sensor
grounding



Electrostatic
discharge (ESD)



Bond line gap shielding

The above technical information and data should be considered representative or typical only and should not be used for specification purposes. Contact your 3M Technical Representative for details.

*Developmental products have not been introduced or commercialized for general sale, and their formulation, performance characteristics, and other properties, specifications (if any), availability, and pricing are not guaranteed and are subject to change or withdrawal without notice.

Halogen free is defined as having maximum 900 ppm bromine, maximum 900 ppm chlorine, and maximum 1500 ppm total bromine and chlorine, per IEC 61249-2-21.

3M™ Electrically Conductive Gasket Tapes

3M product number	Thickness mil (mm)	Carrier type	Conductive filler type	Adhesive type	Liner type	Operating temp °C	Unique features and benefits
MSG7030SDX	11.8 (0.3)	Foam laminated with conductive fabric	Polyurethane plated with Cu/Ni (foam)	Conductive Acrylic PSA	PET film liner	ST -40°C LT 105°C	<ul style="list-style-type: none"> » Anticipated single-sided conductive adhesive » Anticipated to have thicker versions available vs 3M gasket MSG6000F series » Anticipated highly compressible foam structure for wide range gap filling capability
MSG7100SDX	39.4 (1.0)						
MSG7150SDX	59 (1.5)						
MSG7200SDX	78.7 (2.0)						
MSG7250SDX	98.4 (2.5)						
MSG7300SDX •Coming soon•	118 (3.0)						
ECG7053H	20.8 (0.53)	Plated polyurethane foam	Ni	Acrylic	PE coated paper liner	ST 125°C, LT 80°C	<ul style="list-style-type: none"> » Single side conductive adhesive » Metal plated » Open cell urethane
ECG8075H	29.5 (0.75)						<ul style="list-style-type: none"> » Double side conductive adhesive » Metal plated » Open cell urethane

The above technical information and data should be considered representative or typical only and should not be used for specification purposes. Contact your 3M Technical Representative for details.

*Developmental products have not been introduced or commercialized for general sale, and their formulation, performance characteristics, and other properties, specifications (if any), availability, and pricing are not guaranteed and are subject to change or withdrawal without notice.

3M™ EMI Absorbers are flexible composite sheets incorporating specialized magnetic particles and an optional non-conductive PSA to absorb near-field EMI. These absorbers help protect nearby electronics from EMI by suppressing EMI noise at multiple frequencies. 3M absorbers are available with a range of performance characteristics for effective EMI management in different environments from 400MHz to 10 GHz. Reliable resin system options enable high temperature resistance and stable performance over time. These thin magnetic absorbers are used in aerospace & defense, consumer electronics, automotive, and general electronics to help reduce EMI noise and improve the signal-to-noise ratio for optimal system performance.

Features and benefits

- » Absorbing capabilities up to 10GHz with targeted permeability up to 10 GHz
- » Absorbing performance is thickness dependent (ex. 200MHz to 4GHz for 3M absorber EM25TP)
- » Helps improve antenna performance and reduce EMI interference within a device
- » Multiple thicknesses and optional adhesive to create a custom stack-up
- » Longer shelf life options available (up to 2 years)
- » Supplied on a removable liner for easy handling
- » Halogen free

Product construction

3M EMI Absorber & Magnetic Shielding Materials

AB3000 *coming soon* Operating frequency: 1GHz – 10GHz	Absorber Acrylic adhesive (optional) Release liner
EM25TP Operating frequency: 200MHz – 4GHz	

3M EMI Absorbers





AB5000HF, AB5000SHF Operating frequency: 300MHz – 2GHz	Absorber Acrylic adhesive (*optional) Release liner
AB7000E, AB7000HF Operating frequency: 300MHz – 4GHz	
AB8000 (high temp) Operating frequency: 300MHz – 4GHz	

*Select absorber series offer with and without adhesive. Check the Technical Data Sheet to learn more

3M Hybrid Shielding Absorber

AB6005HF (AL+PET), Shielding frequency - 10MHz – 18GHz	AL-PET layer Absorber Acrylic adhesive Release liner
---	---

Applications

 Cable wrapping/ attachment	 Attached to semicon chip/ micro-processors
 Insert between module (compartment)	 Attached to noise (traces, IC's, reflective enclosure surface)

EMI absorbing performance

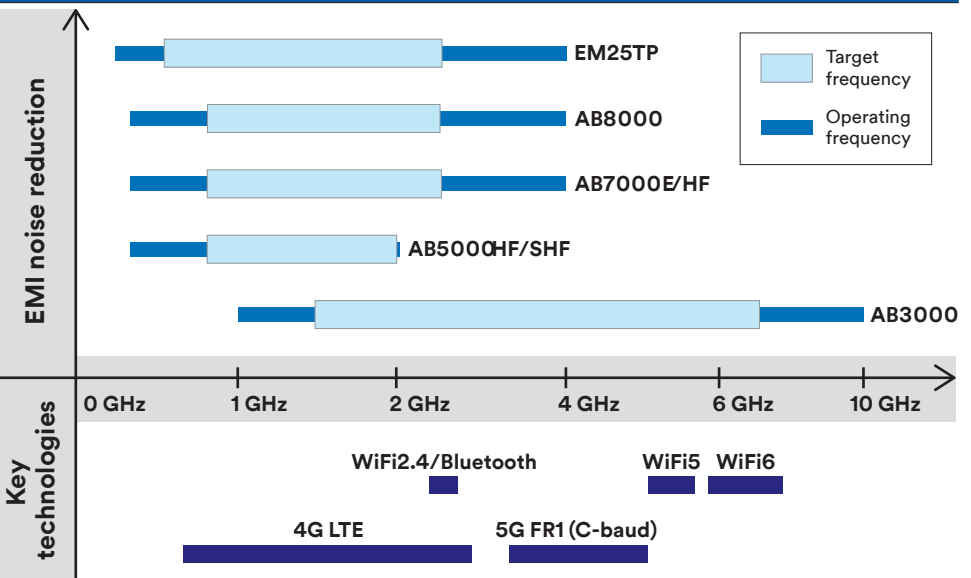

The above technical information and data should be considered representative or typical only and should not be used for specification purposes. Contact your 3M Technical Representative for details.

Halogen free is defined as having maximum 900 ppm bromine, maximum 900 ppm chlorine, and maximum 1500 ppm total bromine and chlorine, per IEC 61249-2-21.

*Developmental products have not been introduced or commercialized for general sale, and their formulation, performance characteristics, and other properties, specifications (if any), availability, and pricing are not guaranteed and are subject to change or withdrawal without notice.

3M product number	Thickness mil (mm)	Adhesive	Initial permeability @1MHz or 3MHz [μ']	Operating frequency MHz-GHz	Operating temp range (°C)	Unique features and benefits
★ EM25TP-005-A10 EM25TP-0100-A10	2 (0.05), 4 (0.1)	Non-conductive acrylic (optional)	250	200MHz – 4GHz	-25 ~ 90°C	<ul style="list-style-type: none"> » Broad frequency absorber » High permeability magnetic film » Absorbing performance 200MHz – 4GHz » Targeted permeability for magnetic shielding <100 kHz – 3 MHz
AB7010HF AB7020HF AB7050HF	5.2 (0.13), 9.8 (0.25), 22 (0.55)		110	300MHz – 4GHz	-25 ~ 85°C	<ul style="list-style-type: none"> » Good workability » High resistivity » High permeability » Improved lower frequency absorber vs the 3M Absorber AB5000 series (@ <1GHz)
AB5100HF/SHF	39 (1.0)	Acrylic non-conductive PSA	55 HF, 30 SHF	300MHz – 2GHz	-25 ~ 85°C	<ul style="list-style-type: none"> » AB5000HF: Standard absorber » AB5000SHF: Advanced EMI absorber, lower peak absorber frequency than 3M EMI Absorber AB5000HF, thermal conductivity 0.7 W/m-K
AB60005HF	4 (0.1)		30 – 250	10MHz – 18GHz	-30 ~ +105°C	<ul style="list-style-type: none"> » Excellent for EMI shielding & insulation » Aluminum layer provides excellent shielding effectiveness up to 18 GHz » Available in sheets or rolls » PET absorber reduces EMI and ESD in enclosed cavities
★ AB7010E/AB7010E-WO AB7020E/AB7020E-WO AB7030E/AB7030E-WO AB7050E/AB7050E-WO	4 (0.1), 8 (0.2), 12 (0.3), 19.5 (0.5)	Non-conductive acrylic (optional)	100 μ' @ 3 MHz	300MHz – 4GHz	-25°C – 105°C	<ul style="list-style-type: none"> » High permeability » Available with and without (-WO) adhesive » Long shelf life (18 months) » Broader temperature performance than 3M absorber AB7000HF series
AB8010-WO AB8030-WO AB8050-WO	4 (0.1), 12 (0.3), 19.5 (0.5)	No adhesive	110 μ' -130 @ 3 MHz	300MHz – 4GHz	-40°C – 150°C	<ul style="list-style-type: none"> » High permeability » High performance resin system for solder reflow stable performance » High temperature resistance (150°C) » Available without adhesive (-WO) » Long shelf life (2 years)
AB3050/AB3050-WO *Coming soon*	19.5 (0.5)	Non-conductive acrylic (optional)	30	1GHz – 10GHz	-25°C – 90°C	<ul style="list-style-type: none"> » Predicted broad absorbing performance 1-10 GHz » Anticipated availability with and without (-WO) adhesive » Large sheet format for improved yield (340mm x 340mm)

★ = Indicates which select thicknesses are part of the GTML.

*Developmental products have not been introduced or commercialized for general sale, and their formulation, performance characteristics, and other properties, specifications (if any), availability, and pricing are not guaranteed and are subject to change or withdrawal without notice.

The above technical information and data should be considered representative or typical only and should not be used for specification purposes. Contact your 3M Technical Representative for details.

3M™ Magnetic Shielding Materials

3M™ Magnetic Shielding Materials are thin magnetic materials that interact and influence electro-magnetic (EM) fields. These materials help protect sensitive electronic components and circuitry by shielding external low magnetic fields (<1MHz). Magnetic shielding materials “capture” the magnetic field and isolate the interference. The high magnetic permeability and low magnetic loss helps enable flux field redirection for applications less than 20MHz.

Features and benefits

- » High permeability magnetic foil
- » Low and resistivity options
- » Good workability
- » Approximately 80,000 permeability dependent on product and thickness
- » Thin overall construction
- » Pressure sensitive acrylic tape for high adhesion
- » Supplied on a removable liner for easy removal

Product construction

3M Single Layer Metal Alloy Foil

EM80KM

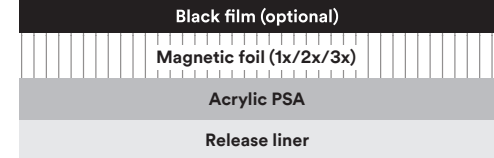

3M Composite Magnetic Foil

EM25TP Series

AB3000 Series
coming soon

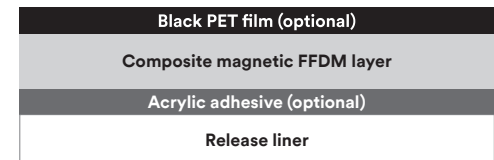

(3M absorber AB3000 does not include a black PET film)

Applications

Enhanced wireless power charging

Improved near field communication (NFC) antenna range

Improved radio frequency identification (RFID) antenna range



3M product number	Total thickness mil (mm)	Magnetic type (magnetic foil layer type)	Adhesive type	Permeability (u')	Operating temp range (°C)	Unique features and benefits
★ 3M™ Flux Field Directional Material EM80KM	2 (0.05)	Soft magnetic foil, nanocrystalline	Acrylic PSA	Max 80,000	-25 ~ 110°C	<ul style="list-style-type: none"> » Low frequency focused for magnetic field » High permeability magnetic foil » Thin overall product construction allows for thinner design
★ EM25TP-005-A10 EM25TP-100-A10	2 (0.05), 4 (0.1)	Soft magnetic composite	Acrylic PSA	250	-	<ul style="list-style-type: none"> » Broad frequency absorber » High permeability magnetic film » Absorbing performance 100MHz - 4GHz » Targeted permeability for magnetic shielding <5MHz - 10MHz
AB3050/AB3050-WO *Coming soon*	19.5 (0.5)	-	Non-conductive acrylic (optional)	30	-25°C – 90°C	<ul style="list-style-type: none"> » Predicted broad absorbing performance 1-10 GHz » Anticipated availability with and without (-WO) adhesive » Large sheet format for improved yield (340mm x 340mm)

*Developmental products have not been introduced or commercialized for general sale, and their formulation, performance characteristics, and other properties, specifications (if any), availability, and pricing are not guaranteed and are subject to change or withdrawal without notice.

★ = Indicates which select thicknesses are part of the GTML.

The above technical information and data should be considered representative or typical only and should not be used for specification purposes. Contact your 3M Technical Representative for details.

Future-tested Solutions

At 3M, we're testing our EMI absorbing and magnetic shielding solutions for the future. Our testing capabilities include:

- Simulation and modeling
- Frequency measurement
- Mechanical property measurement
- Material magnetization
- Reliability testing for age, humidity and temperature cycling
- And more

In many cases, 3M can focus our technical and testing capabilities to help you identify the right solution for you and your customers. No matter what your field, you can feel confident that the 3M solutions you specify will be tested and proven for performance. Virtually anywhere in the world. Now and in the future.

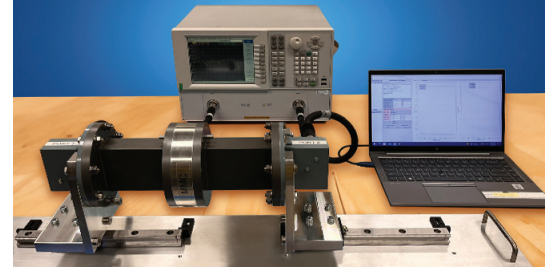

Contact your 3M sales representative or visit [3m.com/electronicassembly](https://www.3m.com/electronicassembly) to learn more.

Regulatory: For regulatory information about this product, contact your 3M representative.

Technical Information: The technical information, guidance, and other statements contained in this document or otherwise provided by 3M are based upon records, tests, or experience that 3M believes to be reliable, but the accuracy, completeness, and representative nature of such information is not guaranteed. Such information is intended for people with knowledge and technical skills sufficient to assess and apply their own informed judgment to the information. No license under any 3M or third party intellectual property rights is granted or implied with this information.

Product Use: Many factors beyond 3M's control and uniquely within user's knowledge and control can affect the use and performance of a 3M product in a particular application. As a result, customer is solely responsible for evaluating the product and determining whether it is appropriate and suitable for customer's application, including conducting a workplace hazard assessment and reviewing all applicable regulations and standards (e.g., OSHA, ANSI, etc.). Failure to properly evaluate, select, and use a 3M product in accordance with all applicable instructions and with appropriate safety equipment, or to meet all applicable safety regulations, may result in injury, sickness, death, and/or harm to property.

Warranty, Limited Remedy, and Disclaimer: Unless a different warranty is specifically stated on the applicable 3M product packaging or product literature (in which case such warranty governs), 3M warrants that each 3M product meets the applicable 3M product specification at the time 3M ships the product. **3M MAKES NO OTHER WARRANTIES OR CONDITIONS, EXPRESS OR IMPLIED, INCLUDING, BUT NOT LIMITED TO, ANY IMPLIED WARRANTY OR CONDITION OF MERCHANTABILITY, FITNESS FOR A PARTICULAR PURPOSE, OR ANY IMPLIED WARRANTY OR CONDITION ARISING OUT OF A COURSE OF DEALING, CUSTOM, OR USAGE OF TRADE.** If a 3M product does not conform to this warranty, then the sole and exclusive remedy is, at 3M's option, replacement or repair of the 3M product or refund of the purchase price.

Limitation of Liability: Except for the limited remedy stated above, and except to the extent prohibited by applicable law, 3M will not be liable for any loss or damage arising from or related to the 3M product, whether direct, indirect, special, incidental, or consequential (including, but not limited to, lost profits or business opportunity), regardless of the legal or equitable theory asserted, including, but not limited to, warranty, contract, negligence, or strict liability.

Disclaimer: For industrial use only. Not intended, labeled or packaged for consumer sale or use.



Electronics Materials Solutions Division

3M United Kingdom plc
3M Centre, Cain Rd, Bracknell RG12 8HT,
United Kingdom
[3m.co.uk/EMI](https://www.3m.co.uk/EMI)

Please recycle.
©3M 2024. All rights reserved.

3M is a trademark of 3M Company.
Used under license by 3M subsidiaries and affiliates.