



LifeASSURE™  
PDA Series Filters

## Integrity Testing Technical Brief

# Table of Contents

- Introduction .....1
- Filter Wet-Out .....2
- Integrity Testing
  - Capsules .....3
  - Pre-Use .....5
  - Post-Use .....6
- Cartridges..... 7
- Trouble Shooting ..... 11
- References ..... 11

## Introduction

The integrity test described herein is a non-destructive method used to confirm that a membrane filter is integral.<sup>1</sup> 3M utilizes an Air Diffusion Rate test method (alternatively known as a Forward Flow Integrity Test - FFIT) to ensure integrity of 3M™ LifeASSURE™ PDA Series Filters. 3M recommends the use of the Air Diffusion Rate test method for evaluating 3M LifeASSURE PDA Series Filters by the end-user to ensure integrity prior to and following use.

The integrity test values for 3M LifeASSURE PDA Series Filters have been determined following the guidelines provided in Parenteral Drug Association (PDA) Technical Report No. 26: Sterilizing Filtration of Liquids (2008)<sup>2</sup> based on complete *Brevundimonas diminuta* retention per ASTM F838<sup>3</sup>. The designs of the pleated modules in 3M LifeASSURE PDA Series Filter Cartridges and Capsules are common, hence, they have identical integrity test values for equivalent filter sizes.

3M recommends the use of an automated integrity test instrument for measuring the air diffusion rate to reduce operator error and allow automated data recording. The operating instructions provided by the instrument manufacturer must be followed and, where required, validated.

3M completes integrity testing as part of the production release. However, this testing only represents the product performance at the point of release. 3M does not guarantee that a filter will be integral at the time of use. Therefore, integrity testing is recommended before and after the filtration process to ensure filter integrity throughout the production process and to minimize the potential requirement for re-processing.

The end-user is responsible for developing and validating their protocols to maintain system sterility, where required.

The wet-out conditions described in this brief require a larger flush volume than the recommended preconditioning flush. As such, the integrity test wet-out is sufficient to accomplish the recommended preconditioning flush.

## Filter Wet-Out

Prior to performing an integrity test, the filter membrane must be thoroughly wet with high purity water. Inadequate wetting of a membrane in the filter is a cause of integrity test failures. Typically, Water for Injection (WFI) or Sterile Water for Injection (SWFI) is used to wet the filter. If the end user process requires wetting the filter with a fluid other than water, testing is required to correlate water integrity test values to those of the process fluid. Product wetted Air Diffusion Rate values need to be validated. 3M offers services to support end-users in executing such product validations.

3M's recommended wet-out parameters are shown in table 1 below.

**Table 1. Wet-out Parameters for 3M™ LifeASSURE™ PDA Series Filters**

<b>Parameter</b>	<b>PDA020</b>	<b>PDA010</b>
Water Flow Rate (L/m <sup>2</sup> /min)		14.5
Back Pressure (psig)*	5	15
Time (mins)		5







\*Back pressure is defined as the pressure immediately downstream of the filter. This pressure is critical to ensure that all pleats and pores are fully accessed and utilized.





More aggressive wet-out conditions (water volume and backpressure) are acceptable, as long as backpressure does not exceed capsule pressure rating or differential pressure rating. 3M can support end-users in validating wet-out protocols.

# Integrity Testing of 3M™ LifeASSURE™ PDA Series Filter Capsules

## Safety Information

Read, understand, and follow all safety information contained in these instructions and the instructions provided with the 3M LifeASSURE PDA Series Filter and housing system, prior to installation and use. Retain these instructions for future reference.

Explanation of Signal Word Consequences	
 <b>WARNING:</b>	Indicates a hazardous situation which, if not avoided, could result in serious injury or death.
 <b>CAUTION:</b>	Indicates a hazardous situation which, if not avoided, could result in minor or moderate injury and/or property damage.
Explanation of Safety and Related Symbols	
	Refer to instructions
	WARNING: Explosion Hazard
	Single Use
	Wear PPE

 <b>WARNING:</b>	
   	<p><b>To reduce the risks associated with chemical exposure, impact, property damage from product loss, bypass or cross contamination due to pressure barrier failure, connector failure, purification media or capsule failure:</b></p> <ul style="list-style-type: none"> <li>• Use the installation procedure specified in Operation Instructions.</li> <li>• Wear Personal Protective Equipment (PPE) to prevent exposure to chemical splash.</li> <li>• Filters are designed for single use only. Do not reuse.</li> <li>• Do not use past the expiration date or product shelf life.</li> <li>• Do not modify or alter the filter.</li> <li>• Do not put into service if any damage is observed.</li> <li>• Do not use where fluid pressure exceeds 4.14 bar (65 psi).</li> <li>• Do not use with organic solvents or flammable liquids. Ethanol or isopropyl alcohol may be used for wet out purposes.</li> <li>• Use only with aqueous based process fluids in the pH range of 5 to 9.</li> <li>• Do not use with or expose this product to hot liquids &gt;40°C (104°F).</li> <li>• Do not use for more than 8 hours.</li> <li>• Do not use this product for continuous service with compressed gasses. Use of compressed gas is permissible for integrity testing and blow-down purposes.</li> <li>• Do not hang other items on the capsule.</li> <li>• Do not suspend capsule from end connections.</li> <li>• Do not ethylene oxide sterilize.</li> <li>• Do not steam-in-place sterilize.</li> <li>• Do not gamma irradiate sterile capsules.</li> <li>• Do not autoclave sterile capsules.</li> <li>• Do not autoclave Gamma compatible capsules more than once.</li> <li>• Do not autoclave Gamma compatible capsules for longer than 30 minutes or above 126°C (259°F).</li> <li>• Do not gamma irradiate gamma compatible capsules above 45 kGy.</li> </ul>

**⚠ WARNING:**



**To reduce the risk of injury from possible end user exposure associated with biological contamination:**



- Use the installation procedure specified in Operation Instructions.
- Filters are designed for single use only. Do not reuse.
- Do not use past the expiration date or product shelf life.
- Do not alter or modify the filter.
- Do not put into service if any damage is observed.
- Do not use with organic solvents or flammable liquids. Ethanol or isopropyl alcohol may be used for wet out purposes.
- Do not use with or expose this product to hot liquids >40°C (104°F).
- Do not ethylene oxide sterilize.
- Do not steam-in-place sterilize.
- Do not gamma irradiate sterile capsules.
- Do not autoclave sterile capsules.
- Do not autoclave Gamma compatible capsules more than once.
- Do not autoclave Gamma compatible capsules for longer than 30 minutes or above 126°C (259°F).
- Do not gamma irradiate gamma compatible capsules above 45 kGy.
- Do not gamma irradiate gamma compatible capsules below 27.5 kGy.

**⚠ CAUTION:**

**To reduce the risk of injury from possible end user exposure associated with chemical release from product:**

- Do not use past the expiration date or product shelf life.
- Do not use with organic solvents or flammable liquids. Ethanol or isopropyl alcohol may be used for wet out purposes.
- Do not use with or expose this product to hot liquids >40°C (104°F).
- Do not ethylene oxide sterilize.
- Do not steam-in-place sterilize.
- Do not gamma irradiate sterile capsules.
- Do not autoclave Sterile capsules.
- Do not autoclave gamma compatible capsules more than once.
- Do not autoclave gamma compatible capsules for longer than 30 minutes or above 126°C (259°F).
- Do not gamma irradiate gamma compatible capsules above 45 kGy.
- Do not autoclave filters with non-autoclave compatible materials.

**⚠ CAUTION:**

**To reduce the risk of fluid exposure:**

- Evaluate the risk of your process liquids to determine an appropriate protocol to dispose of used filters and all other waste.
- Dispose of filters and all other waste in accordance with all applicable local and government regulations.
- The protective caps on the capsule connections are designed for the protection of the capsule. The protective caps are not intended to contain process liquids during the disposal of used capsules.

**⚠ CAUTION:**



**To reduce the risk of burn or exposure injuries associated with autoclave sterilization:**

- Wear Personal Protective Equipment (PPE) to handle hot items.

The test pressure and maximum air diffusion rate for 3M™ LifeASSURE™ PDA Series Filter Capsules are provided in Table 2.

**Table 2. 3M™ LifeASSURE™ PDA Series Filter Capsule Integrity Test Parameters**

Media Grade	Test Pressure bar (psid)	Filter Length (inches)	Wet Out Flow Rate (L/min)	Maximum Air Diffusion Rate (mL/min) in water at 25 °C**
PDA010	4.14 (60.0)	30"	34.0	126.4
		20"	22.7	87.5
		10"	11.4	47.3
		5"	3.8	21.1
		2.5"	1.7	9.7
PDA020	2.76 (40.0)	30"	34.0	104.0
		20"	22.7	71.0
		10"	11.4	38.0
		5"	3.8	15.0
		2.5"	1.7	6.7

\*\*Maximum air diffusion rate values are reported at 25 °C. Temperature affects diffusion rates based on number of factors and may be considered when evaluating this specification. It should be noted that in establishing the maximum air diffusion rate a reasonable safety factor from bacterial retention failure has been used, which will cover a normal range of room temperatures (*i.e.*, 20 °C to 25 °C).

## Pre-Use Integrity Testing Procedure

Refer to Figure 1 for the set-up configuration and valve descriptions.

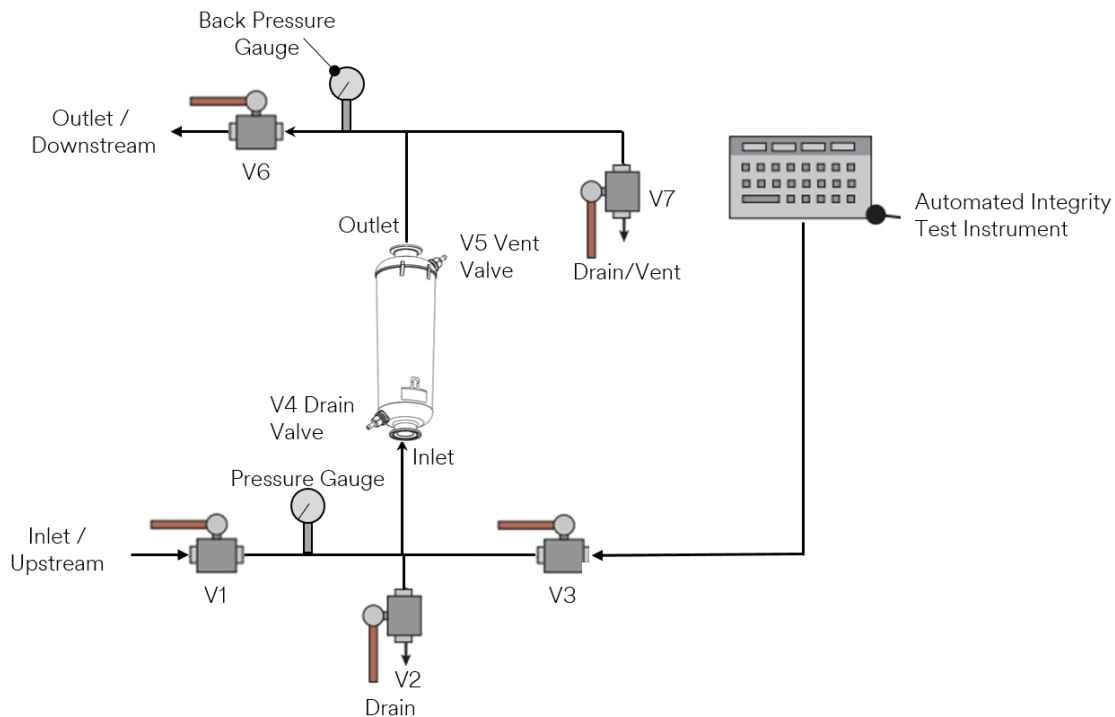

**Figure 1. Capsule Connection and Flow Schematic**

- 1) Assemble the system as shown in Figure 1 with all valves in the closed position.  
**Note:** For the purposes of integrity test wet out, the capsule is flushed in an inverted orientation. This configuration provides superior venting.
- 2) Open valves V1 and V5.
- 3) Flow water at a low flow rate (~10% of value recommended in Table 2) to fill the capsule body.
- 4) Close the vent valve V5 when all air has been expelled from the system.
- 5) Slowly open valve V7 if rinse water is to be directed to the drain or valve V6 if the rinse water is to be directed to the downstream system.
- 6) Increase water flow through the capsule to flow rate in Table 2.
- 7) Adjust outlet valves V6 or V7 to achieve a minimum of 0.35 bar (5 psig) back pressure.
- 8) Flush for five minutes.
- 9) Shut off the pump and close valves V1 and V6/V7.
- 10) Open valves V5 and V7 to vent, and open system drain valve V2 to drain the system.
- 11) After the system has completely drained close valves V2 and V5. Valve V7 remains open.
- 12) Open valve V3.
- 13) Setup and operate automated integrity test instrument according to the manufacturer's instructions. Perform the air diffusion integrity test. Upon completion of integrity test, close V3.
- 14) Open valve V2 to vent any water that has been liberated from media due to pressurization of capsule. Close valve V2.
- 15) When properly programmed, the instrument will provide information on the measured value relative to acceptance criteria provided in Table 2. The capsule may be placed into service if the test air diffusion rate value is less than or equal to the maximum air diffusion rate value.

**Note:** When conducting a pre-use integrity test with autoclave sterilized capsules, the capsules should be wet prior to autoclaving. This is in addition to the required wet-out before testing (after autoclaving).





## Post-Use Integrity Testing Procedure



The above procedure describes the process for conducting a pre-use integrity test. For a post use test, the filter can be flushed as above, then removed from the flush setup and connected directly to the automated integrity test instrument.

# Integrity Testing of 3M™ LifeASSURE™ PDA Series Filter Cartridges

## Safety Information

Read, understand, and follow all safety information contained in these instructions and the instructions provided with the 3M LifeASSURE PDA Series Filter and housing system, prior to installation and use. Retain these instructions for future reference.

Explanation of Signal Word Consequences	
 <b>WARNING:</b>	Indicates a hazardous situation which, if not avoided, could result in serious injury or death.
 <b>CAUTION:</b>	Indicates a hazardous situation which, if not avoided, could result in minor or moderate injury and/or property damage.
Explanation of Safety and Related Symbols	
	Refer to instructions
	Single Use
	Wear PPE

 <b>WARNING:</b>	
	<p><b>To reduce the risk of injury from possible end user exposure associated with biological contamination:</b></p> <ul style="list-style-type: none"> <li>• Use the installation procedure specified in Operation Instructions.</li> <li>• Filters are designed for single use only. Do not reuse.</li> <li>• Do not use past the expiration date or product shelf life.</li> <li>• Do not alter or modify the filter.</li> <li>• Do not put into service if any damage is observed.</li> <li>• Do not use with organic solvents or flammable liquids. Customer must conduct its own risk assessment and evaluation if they wish to validate other liquids for their product.</li> <li>• Do not use with or expose this product to hot liquids &gt;80°C (176°F).</li> <li>• Do not ethylene oxide sterilize.</li> <li>• Do not gamma irradiate cartridges.</li> <li>• Do not autoclave cartridges more than once.</li> <li>• Do not autoclave cartridges for longer than 30 minutes or above 126°C (259°F).</li> </ul>
	

 <b>CAUTION:</b>	
	<p><b>To reduce the risk of injury from possible end user exposure associated with chemical release from product:</b></p> <ul style="list-style-type: none"> <li>• Do not use past the expiration date or product shelf life.</li> <li>• Do not use with organic solvents or flammable liquids. Customer must conduct its own risk assessment and evaluation if they wish to validate other liquids for their product.</li> <li>• Do not use with or expose this product to hot liquids &gt;80°C (176°F).</li> <li>• Do not ethylene oxide sterilize.</li> <li>• Do not gamma irradiate cartridges.</li> <li>• Do not autoclave cartridges more than once.</li> <li>• Do not autoclave cartridges for longer than 30 minutes or above 126°C (259°F).</li> <li>• Do not autoclave filters with non-autoclave compatible materials.</li> </ul>



**⚠ CAUTION:**



**To reduce the risks associated with chemical exposure:**

- Wear Personal Protective Equipment (PPE) to prevent exposure to chemical splash.

**⚠ CAUTION:**

**To reduce the risk of fluid exposure:**

- Evaluate the risk of your process liquids to determine an appropriate protocol to dispose of used filters and all other waste.
- Dispose of filters and all other waste in accordance with all applicable local and government regulations.

**⚠ CAUTION:**



**To reduce the risk of burn or exposure injuries associated with autoclave sterilization:**

- Wear Personal Protective Equipment (PPE) to handle hot items.

The test pressure and maximum air diffusion rate for 3M™ LifeASSURE™ PDA020 Series Filter Cartridges is 2.76 bar (40.0 psid). The maximum air diffusion and pressure hold values for 3M LifeASSURE PDA020 Series Filter Cartridges is provided in Table 3.

**Table 3. 3M™ LifeASSURE™ PDA020 Series Filter Cartridge Housing Integrity Test Parameters**

3M Filter Housing	# EQSL*	Wet Out Flow Rate (L/min)	Maximum Air Diffusion Rate (mL/min) at 25 °C, H <sub>2</sub> O wetted
1ZVS1	1	11.4	38.0
1ZVS2	2	22.7	71.0
1ZVS3	3	34.0	104.0
1ZVS4	4	45.2	137.0
1ZMS1	1	11.4	38.0
1ZMS2	2	22.7	71.0
1ZMS3	3	34.0	104.0
1ZMS4	4	45.2	137.0
4ZWC1	4	45.2	137.0
4ZWC2	8	90.5	264.0
4ZWC3	12	135.7	390.0
4ZWC4	16	181.0	516.0
8ZWC1	8	90.5	264.0
8ZWC2	16	181.0	516.0
8ZWC3	24	271.4	765.0
8ZWC4	32	361.9	1013.0
11ZWC1	11	124.4	359.0
11ZWC2	22	248.8	703.1
11ZWC3	33	373.2	1044.0
11ZWC4	44	497.6	1384.1
21ZWC1	21	237.5	672.1
21ZWC2	42	475.0	1323.0
21ZWC3	63	712.5	1970.0
21ZWC4	84	950.0	2615.9

\* EQSL = Equivalent Single Length. The number of standard 10" cartridge lengths.

The test pressure and maximum air diffusion rate for 3M™ LifeASSURE™ PDA010 Series Filter Cartridges is 4.14 bar (60.0 psid). The maximum air diffusion and pressure hold values for 3M LifeASSURE PDA010 Series Filter Cartridges is provided in Table 4.

**Table 4. 3M™ LifeASSURE™ PDA010 Series Filter Cartridge Housing Integrity Test Parameters**

3M Filter Housing	# EQSL*	Wet Out Flow Rate (L/min)	Maximum Air Diffusion Rate (mL/min) at 25 °C, H <sub>2</sub> O wetted
1ZVS1	1	11.4	47.3
1ZVS2	2	22.7	87.5
1ZVS3	3	34.0	126.4
1ZVS4	4	45.2	164.8
1ZMS1	1	11.4	47.3
1ZMS2	2	22.7	87.5
1ZMS3	3	34.0	126.4
1ZMS4	4	45.2	164.8
4ZWC1	4	45.2	164.8
4ZWC2	8	90.5	315.3
4ZWC3	12	135.7	463.5
4ZWC4	16	181.0	610.4
8ZWC1	8	90.5	315.3
8ZWC2	16	181.0	610.4
8ZWC3	24	271.4	902.2
8ZWC4	32	361.9	1192.2
11ZWC1	11	124.4	426.6
11ZWC2	22	248.8	829.4
11ZWC3	33	373.2	1228.4
11ZWC4	44	497.6	1625.3
21ZWC1	21	237.5	793.0
21ZWC2	42	475.0	1553.3
21ZWC3	63	712.5	2308.1
21ZWC4	84	950.0	3060.2

Refer to Figure 2 for cartridge housing set-up configuration and valve descriptions.

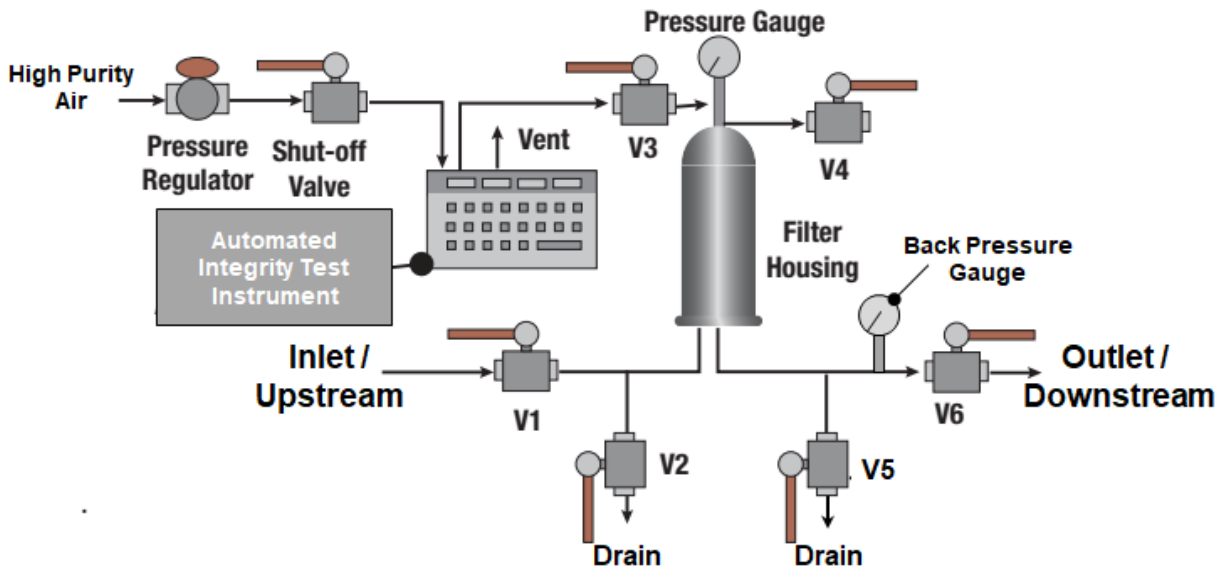

Figure 2. Housing Connection and Flow Schematic

- 1) Assemble the system as shown in Figure 2 with all valves in the closed position.
- 2) Install filter(s) into housing.
- 3) Open valves V1 and V4.
- 4) Flow water at a low flow rate (~10% of value recommended in Table 3/4) to fill the housing.
- 5) Close the vent valve V4 when all air has been expelled from the system.
- 6) Slowly open valve V5 if rinse water is to be directed to the drain or V6 if the rinse water is to be directed through the downstream system.
- 7) Begin water flow through the housing according to flow rates in table 3/4.
- 8) Adjust valve V5 or V6 to achieve a minimum of 0.35 bar (5 psig) back pressure.
- 9) Flush for 5 minutes.
- 10) Shut off the pump and close valve V1.
- 11) Open the vent valve V4, housing drain valves V2 and V5 to completely drain housing.
- 12) After the housing has completely drained close V2 and V4. Leave V5 and/or V6 open.
- 13) Open Valve V3
- 14) Setup and operate automated integrity test instrument according to the manufacturer's instructions. Perform the air diffusion test.
- 15) When the test is complete, close valve V3 and open V4.
- 16) When properly programmed, the instrument will provide information on the measured value relative to acceptance criteria provided in Table 3/4. The cartridge may be placed into service if the test air diffusion rate value is less than or equal to the maximum air diffusion rate value.

## Trouble Shooting

If the air flow or pressure decay rate is higher than the specification, consider the following questions and retest if necessary:

- Was the filter completely wetted out?
- Are the capsule/housing vents fully sealed?
- Was the capsule/housing fully vented?
- Was the correct membrane filter installed?
- Was the temperature of the water and filter ambient?
- Is the automated integrity test instrument programmed correctly for the filter being tested?
- Was the stabilization time adequate?
- Was the test time adequate?
- Was the filter cartridge seated correctly in the housing and were the O-rings undamaged?
- Are there any system/connection leaks on the upstream side of the filter?
- Was the filter wetted with a product other than water that may have affected diffusion values?

## References

1. Baumfalk, Reinhard and Finazzo, Jerry. BioPharm International, Volume 19, Issue 6, pg. (2006).
2. Parenteral Drug Association (PDA) Technical Report No. 26: Sterilizing Filtration of Liquids (2008).
3. ASTM F838 Standard Test Method for Determining Bacterial Retention of Membrane Filters Utilized for Liquid Filtration

### **Product Selection and Use**

Many factors beyond 3M's control and uniquely within user's knowledge and control can affect the use and performance of a 3M product in a particular application. As a result, end-user is solely responsible for evaluating the product and determining whether it is appropriate and suitable for end-user's application, including completing a risk assessment that considers the product leachable characteristics and its impact on drug safety, conducting a workplace hazard assessment, and reviewing all applicable regulations and standards (e.g., OSHA, ANSI, etc.). Failure to properly evaluate, select, and use a 3M product and appropriate safety products, or to meet all applicable safety regulations, may result in injury, sickness, death, and/or harm to property.

### **Warranty, Limited Remedy and Disclaimer**

Unless a different warranty is specifically stated on the applicable 3M product packaging or product literature (in which case such warranty governs), 3M warrants that each 3M product meets the applicable 3M product specification at the time 3M ships the product. 3M MAKES NO OTHER WARRANTIES OR CONDITIONS, EXPRESS OR IMPLIED, INCLUDING, BUT NOT LIMITED TO, ANY IMPLIED WARRANTY OR CONDITION OF MERCHANTABILITY, FITNESS FOR A PARTICULAR PURPOSE, OR ARISING OUT OF A COURSE OF DEALING, CUSTOM, OR USAGE OF TRADE. If a 3M product does not conform to this warranty, then the sole and exclusive remedy is, at 3M's option, replacement of the 3M product or refund of the purchase price.

### **Limitation of Liability**

Except for the limited remedy stated above, and except to the extent prohibited by law, 3M will not be liable for any loss or damage arising from or related to the 3M product, whether direct, indirect, special, incidental, or consequential (including, but not limited to, lost profits or business opportunity), regardless of the legal or equitable theory asserted, including, but not limited to, warranty, contract, negligence, or strict liability.



**3M Purification Inc.**  
**3M Separation and Purification Sciences Division**  
3M India Limited  
48-51, Electronic City, Phase-1, Bangalore-560100

**Phone** 1800-425-3030  
**Web** [www.3mindia.in/3M/en\\_IN/bioprocessing-in/](http://www.3mindia.in/3M/en_IN/bioprocessing-in/)

3M and LifeASSURE are trademarks of 3M Company. All other trademarks are the property of their respective owners. All rights reserved.  
70020256676 REV0520