



# Cold Shrink QS2011-3T-WS Trifurcating Transition Splice Kit

## Instructions

for Shielded and Belted PILC Cable

### IEEE Std. 404-1993

15 kV Class  
110 kV BIL

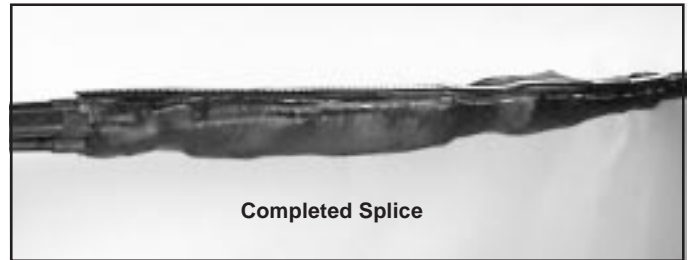

Completed Splice



UniShield®

Wire Shielded

Longitudinally Corrugated (LC)

Tape Shielded (Ribbon Shielded)

Jacketed Concentric Neutral (JCN)

### Cable Size Range Requirements

PILC Conductor Size	#4 - 3/0 AWG (25 - 95 mm <sup>2</sup> )
Poly/EPR Conductor Size	#2 - 4/0 AWG (50 - 100 mm <sup>2</sup> )
Poly/EPR Insulation O.D.	0.64" to 1.07" (17,8 - 27,2 mm)

### Connector Dimensional Requirements

	Minimum inches (mm)	Maximum inches (mm)
<b>Outside Diameter</b>	0.56" (15 mm)	1.10" (28 mm)
<b>Length</b> Aluminum (Al/Cu)	2.0" (51 mm)	5.2" (132 mm)
<b>Length</b> Copper (Cu)	2.0" (51 mm)	5.5" (140 mm)



3 Conductor PILC (Shielded)



3 Conductor PILC (Belted)

## 3M™ Cold Shrink QS2011-3T-WS Trifurcating Transition Splice Kit

78-8124-4256-0-A

## Contents:

1.0	Prepare PILC Cable .....	3
2.0	Install Oil Stop .....	7
3.0	Install Splice Bodies .....	10
4.0	Install Splice Shields .....	13
5.0	Install Splice Jacket Sleeve .....	18

## 1.0 Prepare PILC Cable

**Note:** Use Components From Bag #1.

1 - plastic sheath seal mold

1 - 3M™ Cold Shrink oil stop tube for lead

1 - folded inner sheath seal

1 - roll Scotch™ Super 33+ tape

2 - 1 1/2" x 1 3/4" (38 mm x 44 mm) mastic pads

**Note:** The core material being removed when installing Cold Shrink assemblies is polypropylene and can be recycled with other PP wastes.



1.1 Train the PILC cable end into splice position.

1.2 Slide plastic sheath seal mold and Cold Shrink oil stop tube for lead onto PILC cable with loose core ribbon ends going on first.

**Slide parts onto the cable in the order shown, with the plastic sheath seal mold going on the cable first.** Do not reverse the order.

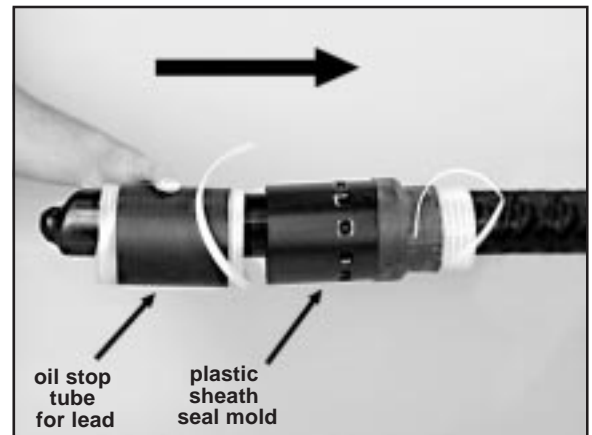

1.3 If PILC cable has a jacket, remove 26" (660 mm) from cable end.

1.4 If surface irregularities can be seen on the surface of the exposed lead, scrape the surface of the lead smooth for a distance of 10" (250 mm) from the 26" (660 mm) dimension toward cable end.

**Note:** Completely remove any surface irregularities from lead surface (grooves, nicks and etc.)

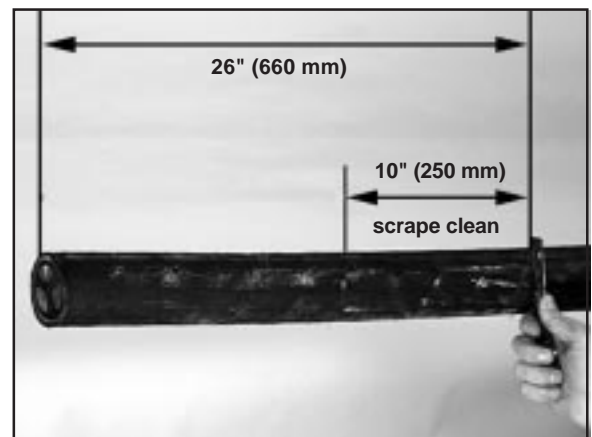

1.5 Ring Score the lead 17" (430 mm) from cable end.

1.6 Remove 17" (430 mm) of lead from cable end.

**Note:** Do not bell the end of the lead. Remove any sharp edges at end of lead.

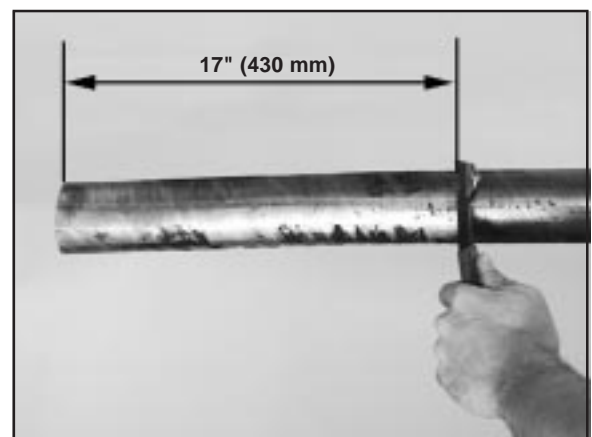

1.7 Remove paper and/or metallic binder from around cable conductors to the end of the lead.



1.8 Separate conductors and remove cable fillers from sides and center of conductors to 1 1/4" (30 mm) from the end of the lead.

If the cable is belted cable type, remove belt insulation and cable fillers to 1 1/4" (30 mm) from the end of the lead.

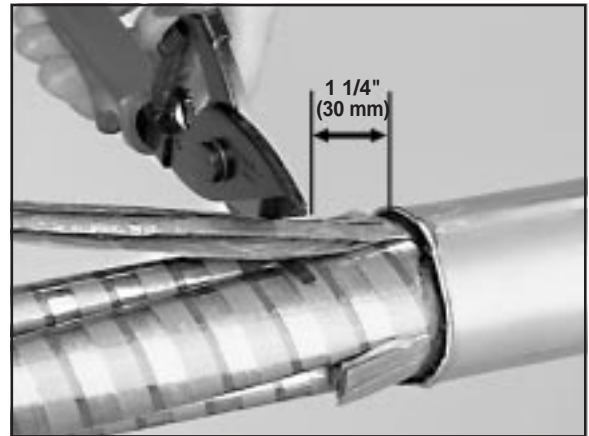

1.9 Clean 9" (230 mm) of exposed lead using a solvent cleaner approved for use on power cables.

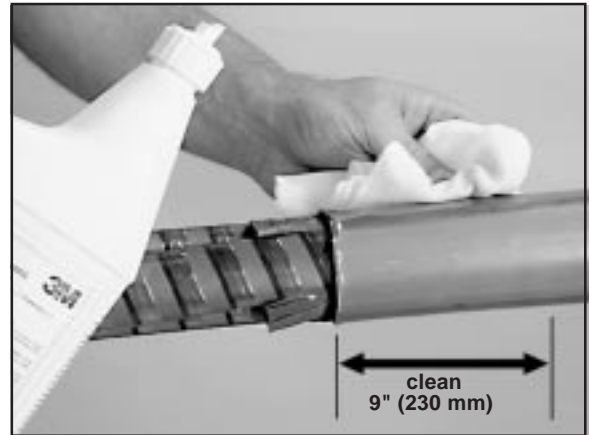

1.10 Bind the metallic shield of each conductor at a point 8 1/2" (220 mm) from conductor ends with two wraps of vinyl tape.

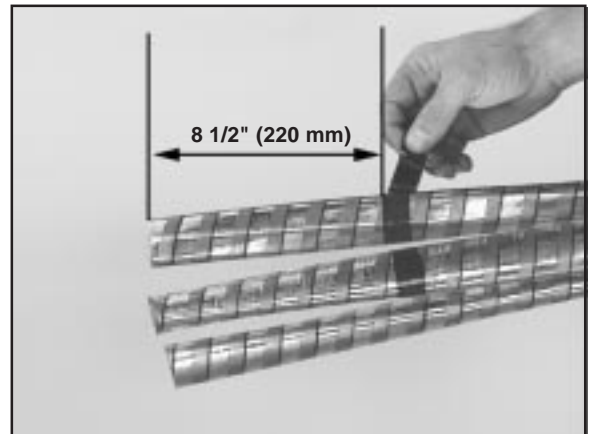

1.11 Remove metallic shield and black semi-conductive paper from conductor ends to the vinyl tape binder.

Note: If black carbon deposits can be seen on the surface of the exposed cable insulation, remove the top layer(s) of paper insulation to the vinyl tape wrap.

#### Connector Dimension Table

Connector	Min. Length	Max Length
Copper	2" (50 mm)	5.5" (140 mm)
Aluminum	2" (50 mm)	5.2" (130 mm)

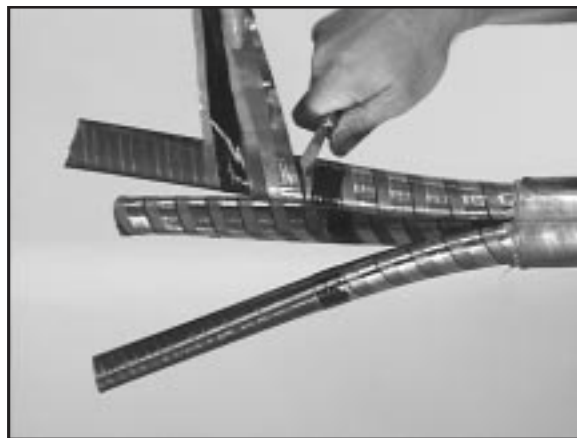

1.12 The insulation removal dimension for the 3M™ 2000T series connectors sized #4 - 3/0 AWG (25mm-95mm<sup>2</sup>), either copper or aluminum, is 3" (75 mm).

*Note: Determine insulation removal dimension for connectors other than the 3M™ 2000T series by adding together the depth of connector barrel, plus any growth resulting from crimping, plus 1/2" (13 mm).*

1.13 Bind the paper insulation at the determined cutback dimension with two wraps of vinyl tape.

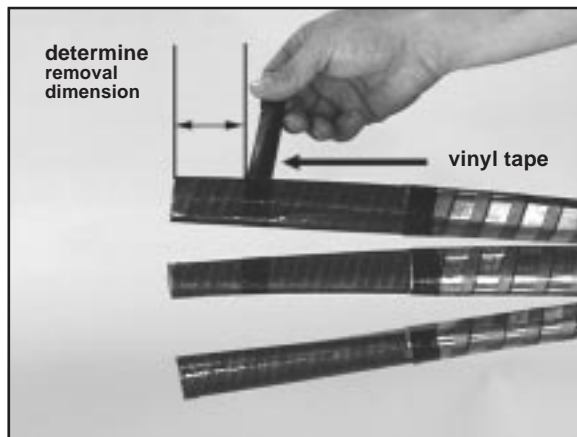

1.14 Remove insulation from conductor ends to the vinyl tape binding. Leave all bindings in place throughout installation. **DO NOT REMOVE vinyl tape bindings.**



- 1.15 Two 1 1/2" (38 mm) wide by 1 3/4" (44 mm) long mastic pads are provided to impede the flow of oil from between conductors during cable preparation. Force one or both pads of mastic between conductors to within 1 1/4" (30 mm) from lead. If conductors are tight together, the application of mastic may be omitted.

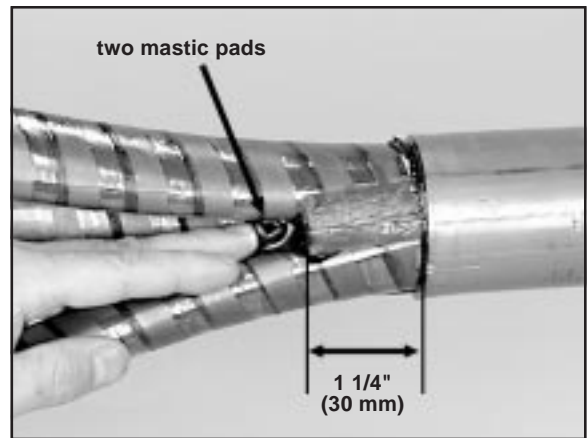

- 1.16 Prepare inner sheath seal for installation.

Before sliding part onto cable, **remove the excess core ribbon that extends beyond the folded rubber** by pulling on each loose core ribbon end.



- 1.17 **Slide the folded inner sheath seal onto cable, with the fold of the rubber going on first.**

Ribbon ends of inner support cores should extend toward cable ends.



- 1.18 Push the inner sheath seal onto the cable until the core ends contact the cable fillers or cable belt insulation. Remove inner support cores from the rubber fingers by pulling while unwinding each loose core ribbon end in a counter-clockwise direction.

Unfold the folded rubber portion and pull the part if necessary **to align the rubber end with the end of the cable lead.**

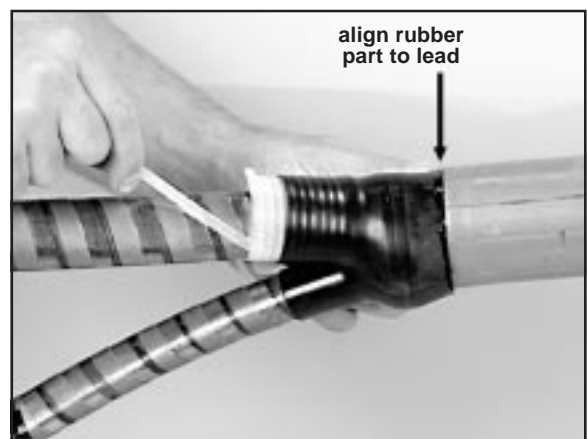

## 2.0 Install Oil Stop

**Note:** Use Components From Bag # 2.

3 - 3M™ Cold Shrink oil barrier tubes  
3 - rolls of white restricting tape  
1 - outer Cold Shrink sheath seal boot

1 - roll Scotch™ 130C rubber tape  
1 - shield to lead continuity assembly

- 2.1 Install appropriately sized oil stop connectors onto the PILC cable conductors. Crimp the connectors per connector manufacturer's directions.  
For crimp information on 3M™ 2000T Series connectors, consult the back page of these instructions.

**DO NOT CRIMP CONNECTOR CLOSER THAN 1/2" (13 MM) FROM END.**

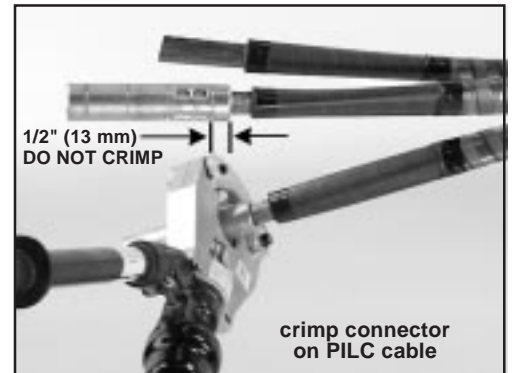

- 2.2 Special Cold Shrink oil barrier tubes may have several windings of core ribbon extending beyond end of rubber.

**Before sliding tubes onto cable conductors, remove the excess core ribbon** by pulling the loose core ribbon end.



- 2.3 Slide special Cold Shrink oil barrier tubes onto cable conductors with the loose ribbon end extending toward cable end. Install each assembly as far as possible onto the fingers of the inner boot.

**Remove core ribbon slowly by pulling, while unwinding the ribbon in a counter clockwise direction.**

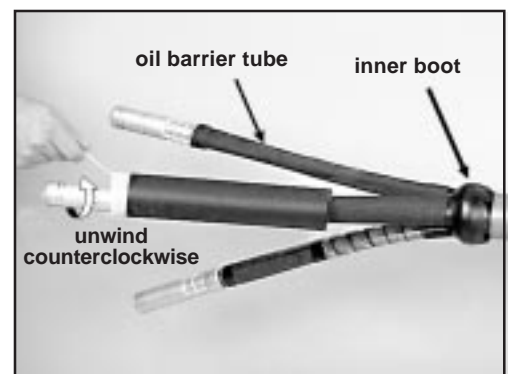

- 2.4 Oil barrier tubes should overlap 1/2" (13 mm) onto connectors. Any excess overlap should be cut off and discarded.

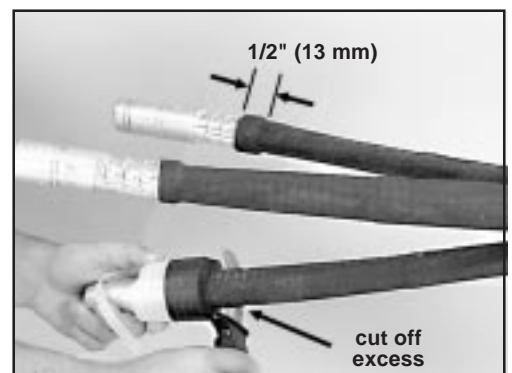



- 2.5 Fill in depression formed between oil/paper cable insulation and connectors with **highly stretched Scotch™ 130C rubber tape**.

Apply final two half-lapped layers 1/2" (13 mm) onto cable insulation and 1/2" (13 mm) onto oil barrier tube over connector. If O.D. of connector is smaller than cable insulation, apply multiple wraps of Scotch 130C rubber tape at connector end to increase diameter to approximate cable O.D.

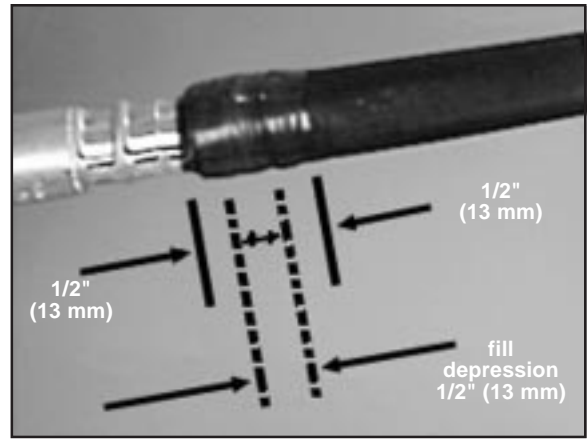

- 2.6 Apply three half-lapped layers of white restricting tape (white tape with smooth surface) over oil barrier tubes and applied Scotch 130C rubber tape. Start the tape at either end of the oil barrier tubes. **Apply the tape as smooth as possible.** To aid application, the white restricting tape may be applied in strips.

**Note:** *Apply white restricting tape with constant tension to avoid wrinkling.*

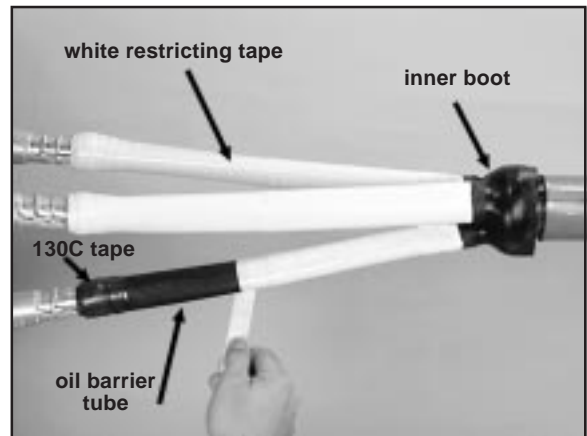

- 2.7 Fold the large section of the inner boot back over itself, exposing the shields of the phase conductors or belt insulation.

**For Cable with Shielded Phase Conductors:**

**Install the shield to lead continuity assembly** consisting of a bent tinned copper strap and two constant force springs. Wrap one end of strap around lead and pull the constant force spring over the top of it, allowing spring to unwrap and rewrap around itself. Install second spring in the same manner over the shields of the phase conductors.

**Note:** *If cable has a metallic binder around phase conductors the continuity assembly may be omitted.*

**For Belted Cable:** Do not install the shield continuity assembly when the cable is a belted type.

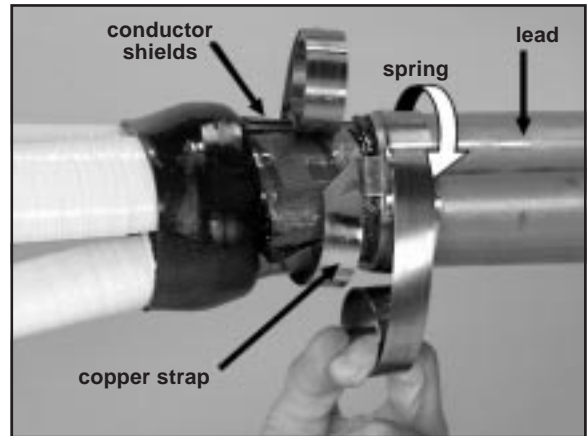

- 2.8 Apply multiple wraps of Scotch 130C rubber tape between the folded inner boot and the end of the cable lead, over the shield continuity strap assembly or belt insulation. Extend the tape 2" (50 mm) onto the end of the cable lead, and apply over the shield continuity assembly if installed.

**Highly elongate (stretch) the tape during application and only apply as much tape as is needed** to provide a tight fit when the inner boot is unfolded over the tape.

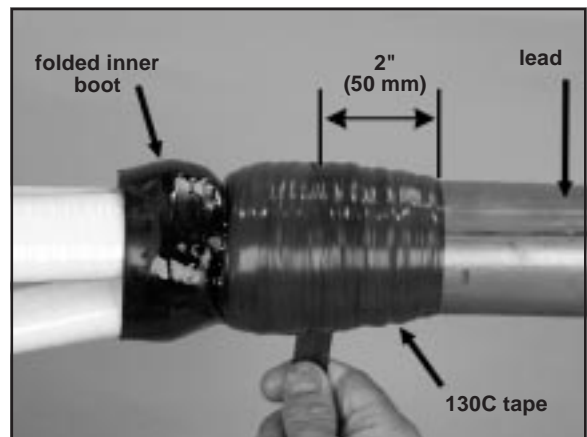



- 2.9 Unfold inner boot over the applied tape. If the boot is loose on the tape, refold the boot and apply additional tape where the boot overlaps the tape.

**Only apply as much tape as is needed.** An excess amount of tape will prevent the installation of the plastic sheath mold.

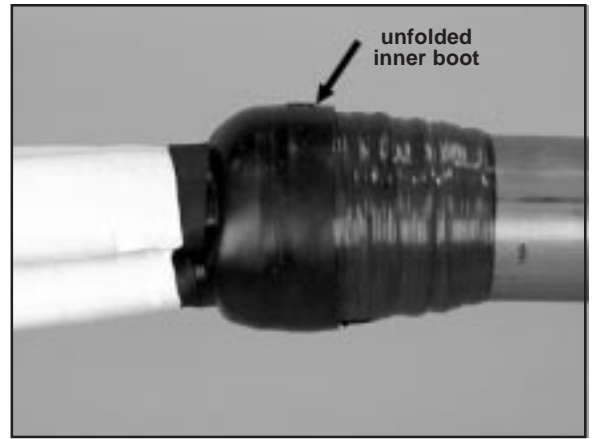

- 2.10 Position the oil barrier tube for lead (previously applied onto PILC cable) over the large portion of inner boot and applied Scotch 130C rubber tape.

Install by pulling while unwinding the loose ribbon end in a counter clockwise direction.

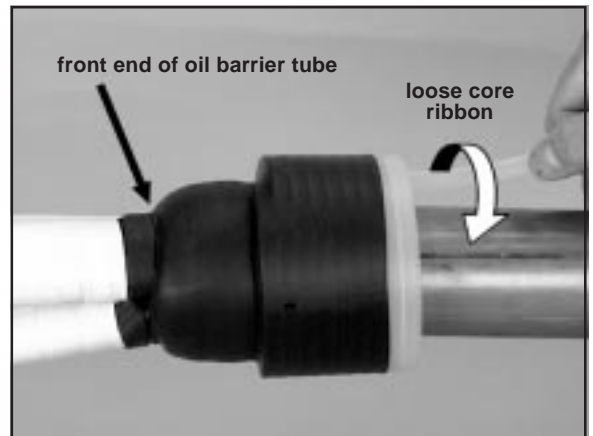

- 2.11 **Apply three half-lapped layers of white restricting tape over the oil barrier tube on lead.**

Start the tape on the lead at end of oil barrier tube. At this location, apply several wraps of the tape until the tape build-up approximates the O.D. of the oil barrier tube, then half lap the tape while applying over tube.

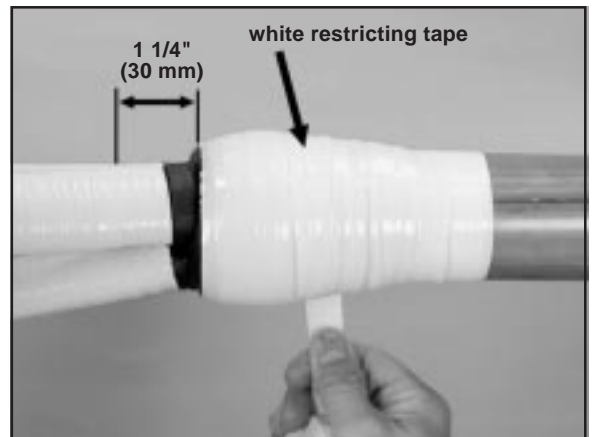

- 2.12 Slide the plastic sheath seal mold over the inner boot. Align leading edge of mold 1 1/4\" (30 mm) over the phase conductors where they extend from the inner boot (shown in 2.10).

Rotate the mold to **locate the notch in the leading edge and air vent channel at the top.** Lock mold into position by removing the inner support core by pulling while unwinding the loose core ribbon end counter clockwise.

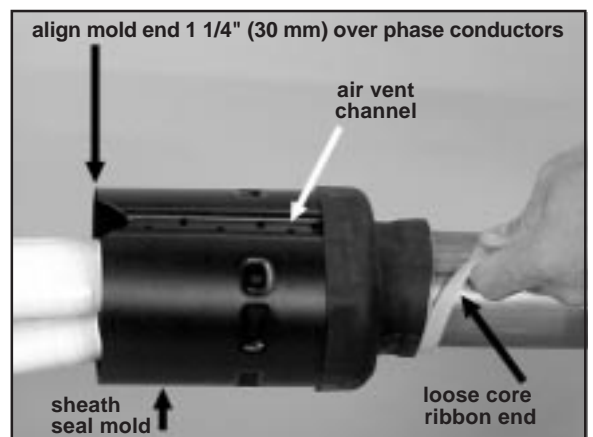

2.13 Remove excess core ribbon from fingers of outer sheath seal part in preparation for installation.

**Remove the excess by pulling slowly** on core's loose ribbon end until the core end on the inside is at the point where it is supporting rubber.

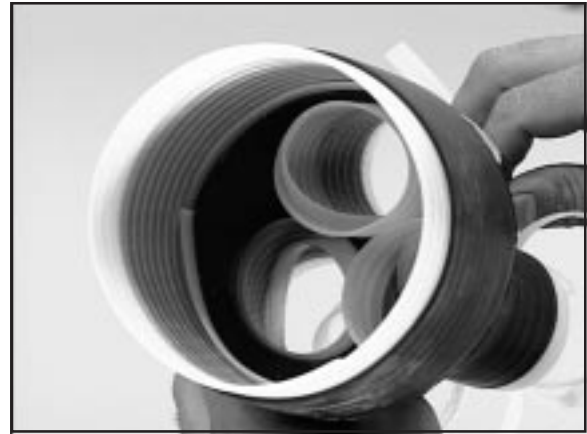

2.14 Slide the outer sheath seal boot onto the PILC cable with the large end going on first.

Pull the boot on until it is tight to the plastic sheath seal mold. Remove the large diameter core and then remove finger cores.

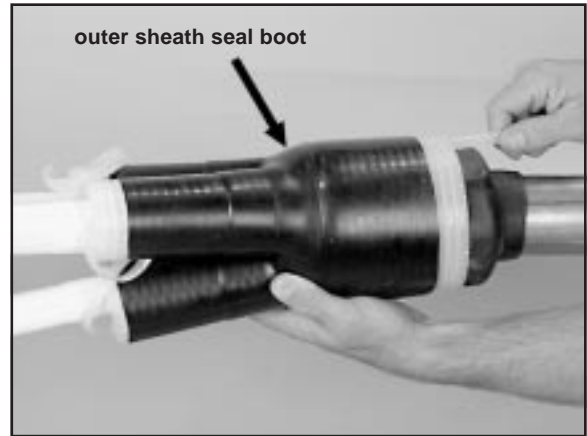

### 3.0 Install Splice Bodies

*Note: Use Components From Bag #3.*

- 1- heat shrink breakout boot*
- 1 - copper shield sleeve*

- 3 - 3M™ Cold Shrink splice bodies*
- 4 - tubes of red P55/R compound*

3.1 Prepare poly/EPR cable ends according to standard practices.

- **For Jacketed Concentric Neutral, Flat Strap Neutral, and Drain Wire Shield Cable refer to 3.1.1.**
- **For Concentric Neutral Cable without a Jacket refer to 3.1.2.**
- **For UniShield® Cable refer to 3.1.3.**
- **For Tape Shield and LC (Longitudinally Corrugated) Shield Cable refer to 3.1.4.**

3.1.1 For Jacketed Concentric Neutral, Flat Strap Neutral, and Drain Wire Shield:

Remove 14" (350 mm) of cable jacket and fold the neutral wires straight back over jacket end and tape ends of wires to the cable.

3.1.2 For Concentric Neutral without a jacket, wrap a tape band around the neutral wires at 14" (350 mm) from cable end. Fold the neutral wires over the tape band and tape ends of wires to the cable.

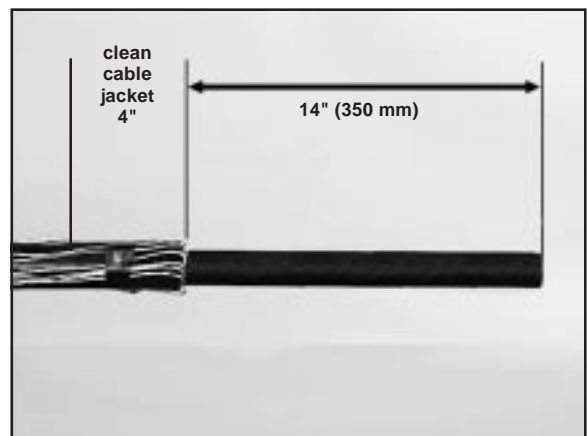

3.1.3 For UniShield<sup>®</sup> Cable:

Pull the drain wires out of the semicon a distance of 14" (350 mm) from cable end. Fold the wires back over the cable where they come out of the semicon and tape ends of wires to the cable.

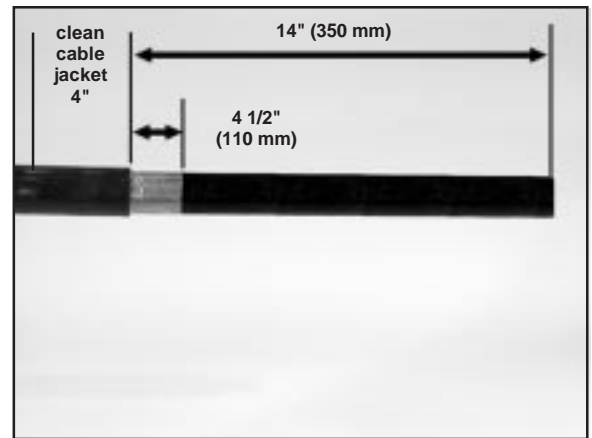

3.1.4 For Tape Shield and L C Shield:

Remove 14" (350 mm) of cable jacket. Remove the metallic shield leaving 4 1/2" (110 mm) of shield exposed beyond cable jacket end.

3.2 For all cable types:

Remove 7 1/4" (185 mm) of cable semi-con insulation shield from cable ends.

3.3 If using 3M<sup>™</sup> 2000T series connectors sized #2 - 4/0 AWG (50 - 100 mm<sup>2</sup>) remove 2 1/2" (65 mm) of cable insulation from cable end.

*Note: Determine insulation cutback dimension for connectors other than the 3M<sup>™</sup> 2000T series by adding together the depth of the connector barrel plus any growth resulting from crimping.*

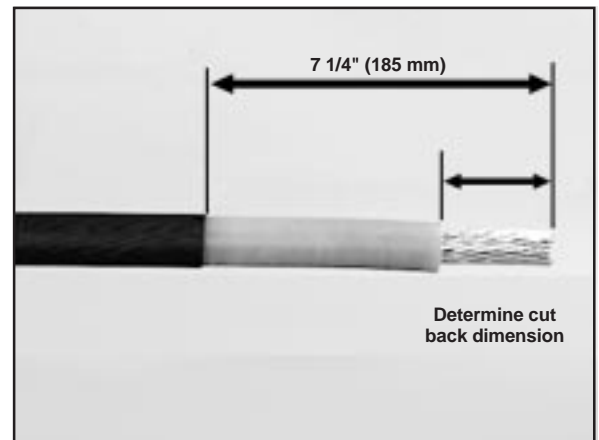

3.4 Slide the heat shrink breakout boot onto poly/EPR cables with the finger extensions going on the cable first, away from the cable ends.



3.5 Slide a splice body onto each poly/EPR cable. The loose core ribbon end should go on the cable first, away from cable end. The splice end with semi-conductive insulation shield extension should be closest to cable end.

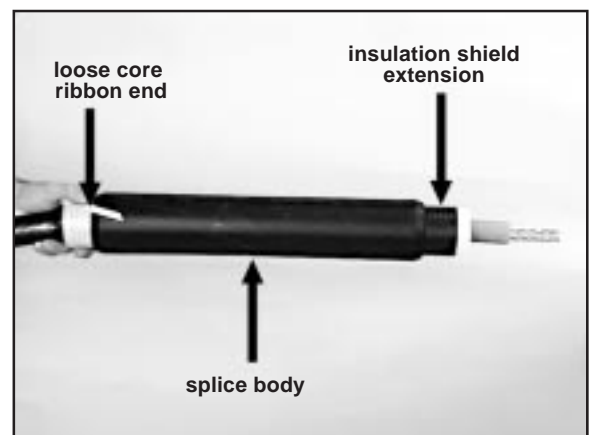

3.6 **Expand the diameter of the shield sleeve** by compressing the sleeve ends together and slide the sleeve into park position on the PILC cable.



3.7 **Crimp poly/EPR cable conductors** into connectors. Follow connector manufacturers directions when crimping.

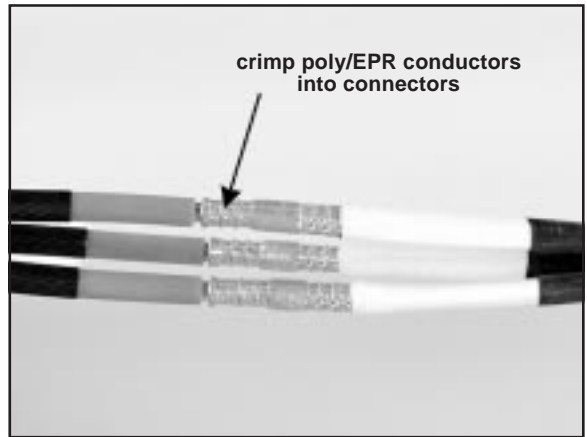

3.8 **Apply a liberal amount of P55/R compound** at the semi-con step of both cables and over the white restricting tape on the PILC cable. Any extra compound may be applied along the poly/EPR insulation surface.

**IMPORTANT: DO NOT SUBSTITUTE SILICONE GREASE FOR P55/R COMPOUND.**

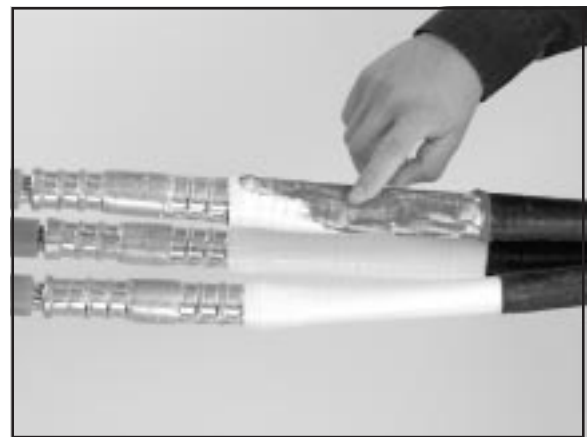
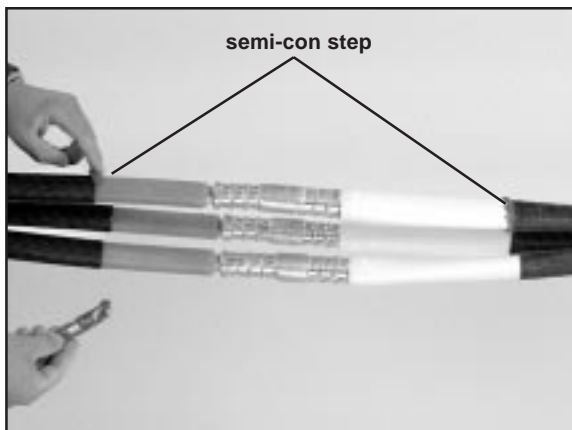

- 3.9 Place a mark on PILC cable conductor 11 3/4" (300 mm) from connector center. **Slide splice body over connector and align leading edge of semi-con extension to mark.** Slowly pull while unwinding the inner support ribbon.

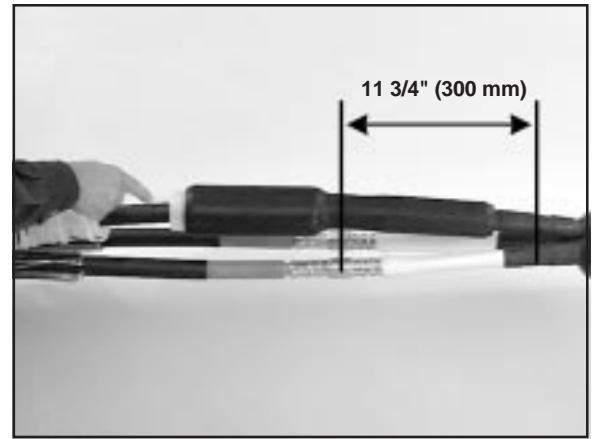

## 4.0 Install Splice Shields

*Note: Use Components From Bag #4:*

*3 - U shaped ground braids*

*1 - roll Scotch™ 2228 Rubber Mastic Tape*

*6 - small constant force springs*

*5 - large constant force springs*

*6 - copper overlap connectors*

*6 - 6" (152 mm) long mastic sealing strips*

- 4.1 **For Horizontal Installation:** Cut a slit using a diagonal cutter or similar tool 3/8" (10 mm) long in the top of the sheath seal boot where the notch section in the plastic mold part can be felt.

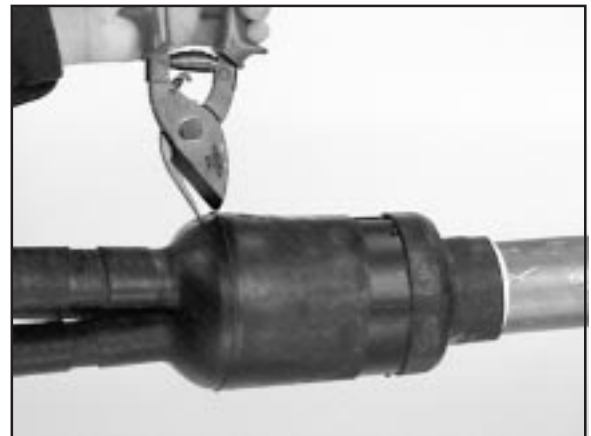

- 4.1.1 **For Vertical Installation:** Lubricate a handle of diagonal cutter, plier or similar tool, with a light film of P55/R compound.

**Insert the lubricated handle down the interface between a finger extension of the outer sheath seal and phase shield tube.** The inserted tool handle provides an air vent. Air will escape from the sheath seal along the sides of the tool handle while the resin is injected.

**Make a 3/8" (10mm) long cut in the top of the sheath seal** on the opposite side of the inserted tool handle. Resin will be injected through the cut in the rubber.

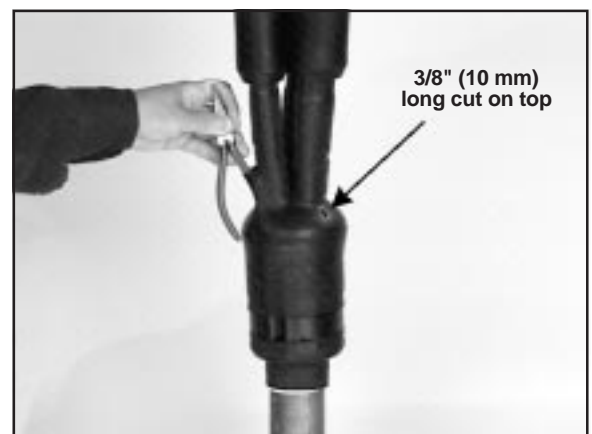

- 4.1.2 **For Vertical Installation:** Apply vinyl tape around the exposed plastic portion of the sheath seal to close off the vent channel.



- 4.2 Tear the top off the foil guard bag containing the 3M™ Scotchcast™ #4 resin. Remove the resin bag and place a thumb on each side of the bag next to the barrier strip that keeps the resin from the hardener. Roll thumbs towards the barrier, forcing it to separate. Pull outward on the sides of the bag, allowing the resin to mix with the hardener. Squeeze the bag 30 to 40 times to force the compound to mix.



- 4.3 Separate the barrier next to bag nozzle by positioning thumbs the same way as before. Allow compound to flow into the injection nozzle.

- 4.4 Inject Scotchcast #4 resin.



- 4.4.1 **For Horizontal Installation:** Insert nozzle into the cut in the rubber sheath seal boot and squeeze bag to force compound from bag to sheath seal.

When compound is visible in the air vent channel of the rigid plastic part, the sheath seal is full.

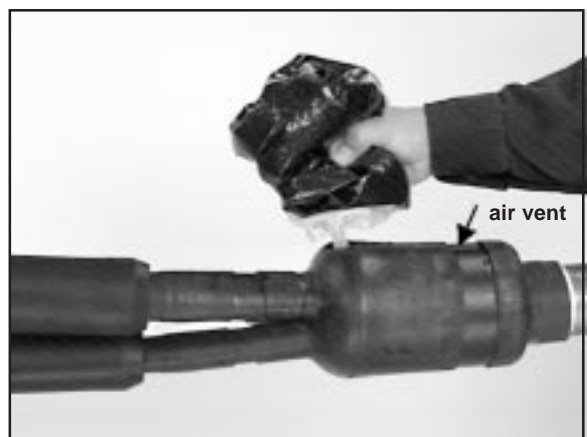



- 4.4.2 **For Horizontal Installation:** Apply one half-lapped layer of vinyl tape around the resin filled boot to cover the air vent channel and the resin injection hole.

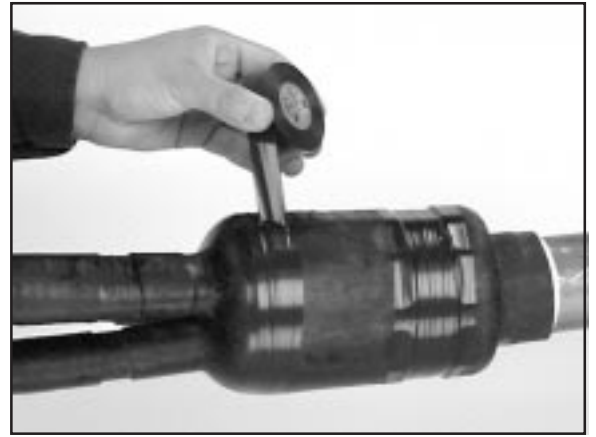

- 4.4.3 **For Vertical Installation:** Insert the nozzle into the cut in sheath seal and squeeze bag to force the compound from the bag to the sheath seal. When compound is visible along the sides of the inserted tool handle, the sheath seal is full. Remove the nozzle and tool handle from sheath seal finger extension when full. Wipe tool handle clean.



- 4.5 **For Jacketed Concentric Neutral, Flat Strap Neutral, Drain Wire Shield and other cable types:** Make a seal at the end of the poly/EPR cable jackets using two 6" (250 mm) long mastic sealing strips per cable. To make the seal, remove liners from mastic. When cable has shield wires, wrap first strip under wires and the second over the wires at the cable jacket end. Cover the mastic with a wrap of vinyl tape.

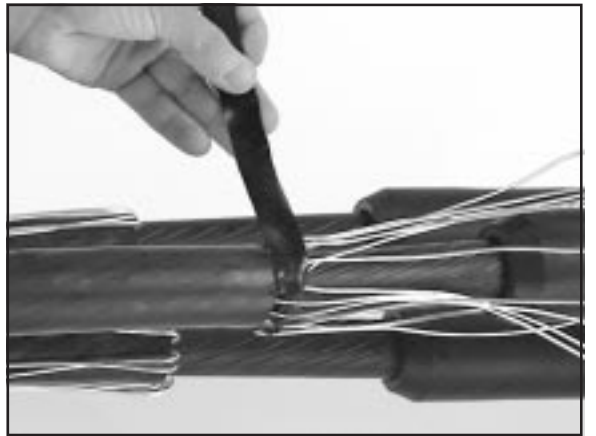

- 4.6 **Install the three U-shaped ground braids** by wrapping center section of each braid around the PILC cable lead. Make the first connection next to the sheath seal and make subsequent connections next to each preceding connection.



4.7 Extend braid tails toward the poly/EPR cable and spiral wrap the two tails from each braid around a separate splice body.

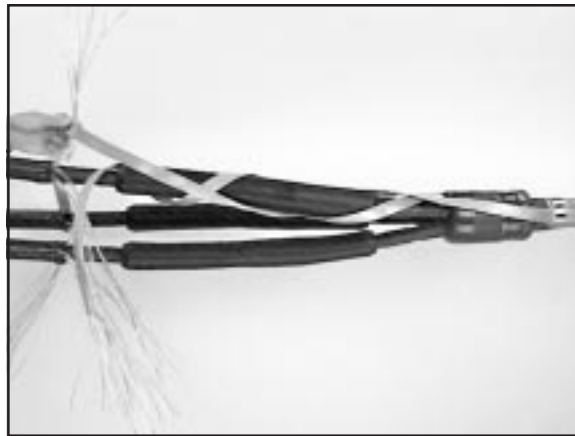

4.8 Connect braid tails to poly/EPR cable.

4.8.1 **For Concentric Neutral Cable, Jacketed Concentric Neutral Cable, Flat Strap Neutral Cable, Unshield Cable, Wire Shield Cable:**

Separate the neutral wires of each poly/EPR cable into two equal groups. Slide an overlap connector onto each braid tail and crimp a neutral wire group into each connector at the end of the splice bodies using an indent type crimp tool. Cut off and discard excess braid and cable shield wires.



4.8.2 **For Tape Shield Cable and LC (Longitudinally Corrugated) Shield Cable:**

Connect braid tails to cable shields using small constant force springs. Make first connection at shield end by folding a braid tail 90° to the shield. Wrap braid tail around cable shield and at the point where braid tail would overlap, cut off and discard excess. Hold spring coil over the folded braid section and pull the coil around the cable allowing the spring to unwrap and rewrap around the cable and itself. Install a second braid tail on each cable next to the first spring using the same procedure.

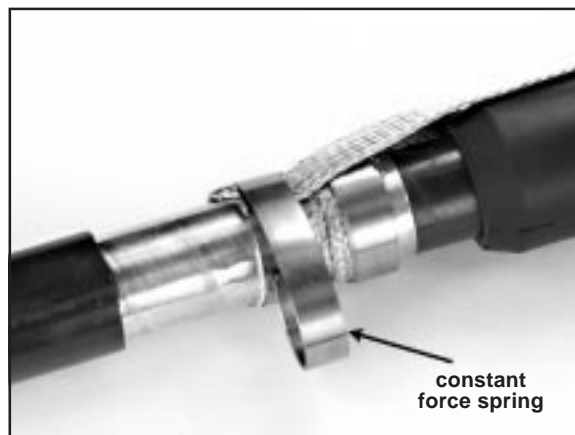

4.9 Form the overall shield sleeve (previously parked on lead cable) across the splice.

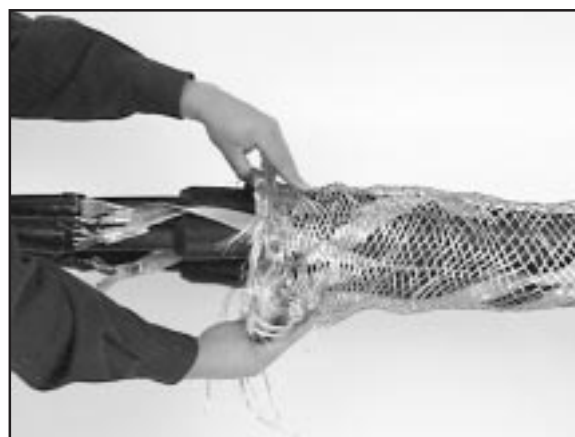

- 4.10 **Connect shield sleeve to poly/EPR cable shield** by wrapping a large constant force spring around all three cables. Install springs beyond overlap connectors or previously installed constant force springs. Install springs by wrapping one wrap of spring around the braid, then fold remaining braid end back over spring and complete spring installation.

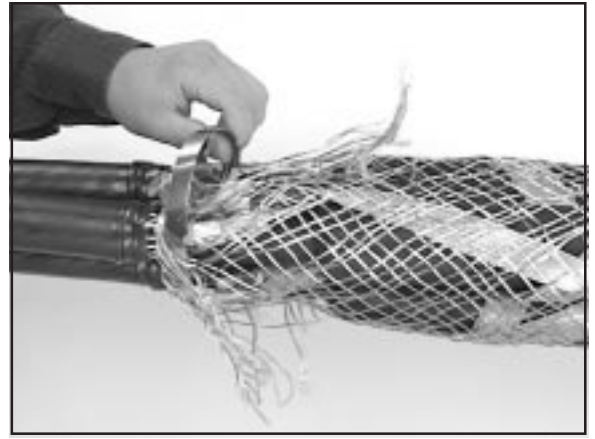

- 4.11 **Form the shield sleeve tight to the cable splices and install a large constant force spring around sleeve on lead** beyond previously installed springs. Wrap one wrap of spring over the shield sleeve and fold shield sleeve back over spring and complete spring installation. Cut off excess braid wires and apply vinyl tape over ends of braid wires.



- 4.12 **Make a sealing collar around the PILC cable just beyond the shield connection** using approximately 3' (900 mm) of 3M™ Scotch™ 2228 Rubber Mastic Tape. If PILC cable has a jacket, center the tape on the end of the jacket.



- 4.13 **Make a sealing collar around the jacket ends of the three poly/EPR cables** using approximately 3' (900 mm) of 2228 Rubber Mastic Tape.

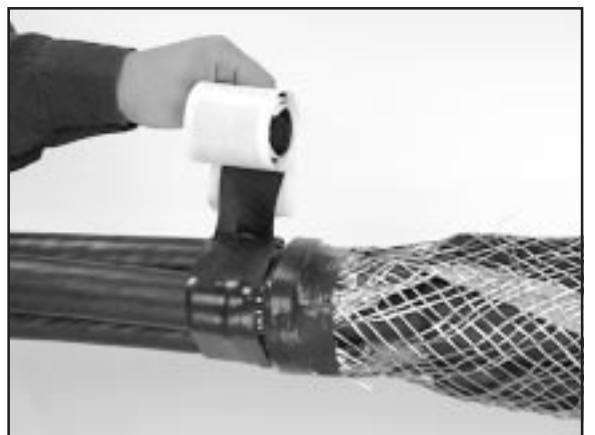

- 4.14 Slide the 3M™ heat shrink breakout boot over the applied 3M™ Scotch™ 2228 on the poly/EPR cables.

Using an open flame torch, shrink the boot in place starting with the fingers and working toward the splice.

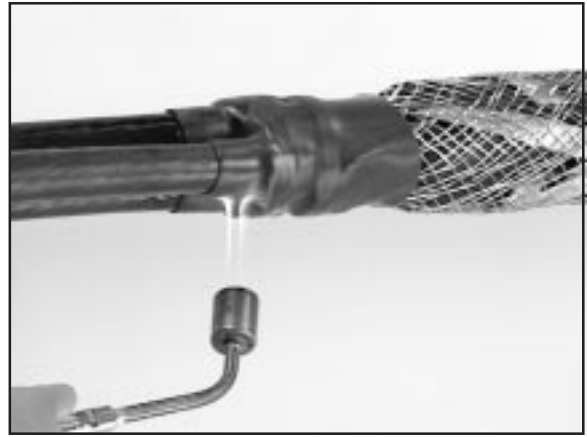

- 4.14 When the breakout has cooled sufficiently to touch, apply the remainder of the Scotch 2228 tape around the body of the breakout boot 1 1/2" (40 mm) from boot end.

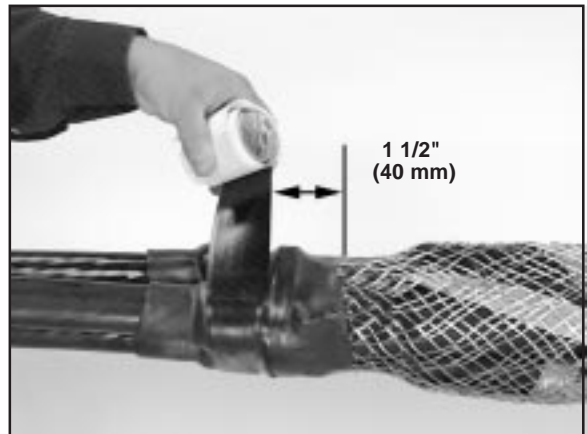

## 5.0 Install Splice Jacket Sleeve

- 5.1 Remove wraparound sleeve from poly bag and remove the poly liner on the adhesive side of the sleeve.



- 5.2 Center the sleeve over the splice and slide the metal channels towards the center from each end.

A minimum of 1/4" (6 mm) of channel should be extended beyond the edges of the sleeve. Make sure the overlap flap is not pinched between rails. To aid channel installation, push the sleeve up from the bottom and down from the top while sliding on channels.



- 5.3 **Shrink wraparound sleeve.** Using an open flame torch, begin by preheating the channel area. Move the flame from one side of the channel to the other along its entire length to achieve uniform heating, until the sleeve starts to shrink.



- 5.4 Shrink sleeve by starting in the center and working to each end. Apply heat evenly around the sleeve circumference and continue applying heat to the channel area at the rate of 5 seconds per foot (300 mm).

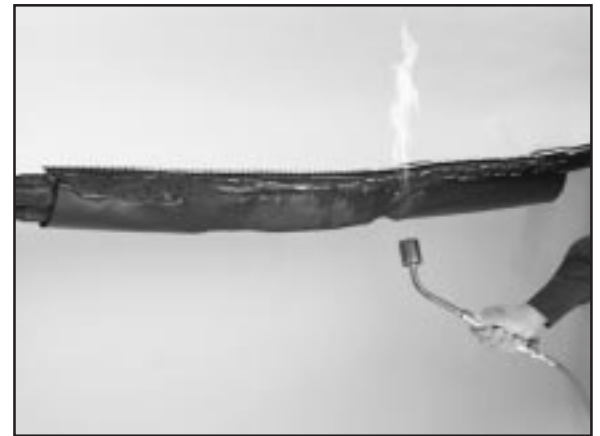

- 5.5 Allow sleeve to cool before moving. Splice is complete.



## Aluminum Connectors (Copper/Aluminum)

Conductor Size (AWG / Kcmil)	Crimping Tool - Die Sets (number of crimps/end)								
	Burndy		Kearny			Thomas & Betts			Anderson
	MD6	Y35, Y39, Y45*, Y46*	0-52 0-51	WH-1, WH-2 WH-3, PH-15	PH25	TBM 5 TBM 8	TBM 12	TBM 14M TBM 15	VC6
4 3 2 1 1/0	BG (5) WBG (2)	UBG (2) U25ART (2) U243 (2)	5/8 to 1 (5)	5/8 to 1 (4)	5/8 to 1 (3)	Olive (2)**	54 (2)**	54H (4)**	Universal (2)
2/0 3/0 4/0	W249 (3)	U28ART (2)	840 (4)	840 (3)	840 (2)	Red (3)**	71H (3)**	71H (3)*	Universal (2)

\* Y45 and Y46 accept all Y35 dies ("U" series). For Y45 us PT6515 adapter. For Y46 use PUADP adapter.

\*\* Excess flash must be filed off to round out connector.

## Copper Connectors

Conductor Size (AWG / Kcmil)	Crimping Tool - Die Sets (number of crimps/end)							
	Burndy				Thomas & Betts			Anderson
	MD6	MY29	Y34A	Y35, Y39, Y45*, Y46*	TBM 5 TBM 8	TBM 12	TBM14M TBM 15	VC6-3 VC6-FT**
4	W161 (1)	4 AWG (1)	A4CR (1)	U4CRT (1)	Grey (1)	29 (1)	29 (1)	Universal (1)
2	W162 (2)	2 AWG (1)	A2CR (1)	U2CRT (2)	Brown (1)	33 (1)	33 (1)	Universal (1)
1	W1CRT (2)	1 AWG (1)	A1CR (1)	U1CRT (2)	Green (1)	37 (1)	37 (1)	Universal (1)
1/0	W163 (2)	1/0 (1)	A25R (1)	U25RT (1)	Pink (2)	42 (1)	42H (2)	Universal (1)
2/0	W241 (2)	2/0 (1)	A26R (1)	U26RT (2)	Black (2)	45 (1)	45 (1)	Universal (1)
3/0	W243 (2)	3/0 (1)	A27R (1)	U27RT (2)	Orange (2)	50 (1)	50 (1)	Universal (1)

\* Y45 and Y46 accept all Y35 dies ("U" series). For Y45 us PT6515 adapter. For Y46 use PUADP adapter.

\*\* Anderson VC6-3 and VC6-FT require no die.

3M, Scotch, ColdShrink, Scotchcast, are trademarks of 3M.  
UniShield® is a registered trademark of BICC Cables.

### IMPORTANT NOTICE

All statements, technical information and recommendations related to the Seller's products are based on information believed to be reliable, but the accuracy or completeness thereof is not guaranteed. Before utilizing the product, the user should determine the suitability of the product for its intended use. The user assumes all risks and liability whatsoever in connection with such use.

Any statements or recommendations of the Seller which are not contained in the Seller's current publications shall have no force or effect unless contained in an agreement signed by an authorized officer of the Seller. The statements contained herein are made in lieu of all warranties, expressed or implied, including but not limited to the implied warranties of merchantability and fitness for a particular purpose which warranties are hereby expressly disclaimed.

SELLER SHALL NOT BE LIABLE TO THE USER OR ANY OTHER PERSON UNDER ANY LEGAL THEORY, INCLUDING BUT NOT LIMITED TO NEGLIGENCE OR STRICT LIABILITY, FOR ANY INJURY OR FOR ANY DIRECT, INDIRECT, INCIDENTAL OR CONSEQUENTIAL DAMAGES SUSTAINED OR INCURRED BY REASON OF THE USE OF ANY OF THE SELLER'S PRODUCTS.

# 3M

Electrical Products Division

6801 River Place Blvd.  
Austin, TX 78726-9000



Recycled paper  
40% pre-consumer  
10% post-consumer

Litho in USA  
© 3M 1998 78-8124-4256-0-B