



AM450/80

NOTICE SPECIFIQUE
SPECIFIC INSTRUCTIONS
ISTRUZIONI SPECIFICHE
MANUAL ESPECIFICO
GERÄTEANWEISUNG

48

POINT D'ANCRAGE
ANCHORAGE POINT
PUNTI DI ANCORAGGIO
PUNTOS DE ANCLAJE
ANSCHLAGPUNKTE

CE EN795/B:12, EN566:06, EN354:10, CEN/TS16415/B:13

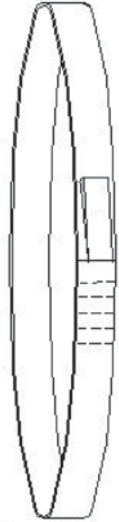

29
6
5
4
7
10

Ref: AM450/XX
N° serie: 5082911201
Serial (fr): 5082911201
Date fab: 08/15/08/25
Mfg date: 08/15/08/25

ID: 50829111

22kN
2x
CE 1019
0,60 m
EN795/B:12, EN566:06, EN354:10, CEN/TS16415/B:13

3
9
3
11
3

PROTECTA
Longueur: 0,60 m
Length: 0,60 m

	0,085kg	Bouclerie Buckle Dispositivo di chiusura Hebilleria Beschlagteile 13	Sangle Webbing Fune Cincha Gurband 15	Fil Thread Filo di cucitura Hilo de coser Naht-garn 12
Longueur Length Lunghezza Longitud Länge 11	0.80 m	Matiere Material Materiale Material Material 18	Polyester Polyester Poliestere Poliester Polyester 20	Polyamide Polyamide Poliammide Poliamida Polyamid 19
Année de fabrication Manufacturing year Anno di fabbricazione Año de fabricación Baujahr 4	2016	EXAMEN CE DE TYPE CE TYPE EXAMEN ESAME CE DEL TIPO EFFETUATO EXAMEN CE DE TIPO EFETUADO POR CE-TYPENPRÜFUNG DURCH 8	N°1019 : VVUU a.s. Pikartska 1377/7 716 07 Ostrava - Radvanice Czech Republic	
BATCH / ID 7		SUMI QUALITE PRODUCTION QUALITY CONTROL ORGANISMO VALUTAZIONE CONFORMITA ORGANISMO DE CONTROLA HERSTELLUNGSKONTROLLE 9	N°1019 : VVUU a.s. Pikartska 1377/7 716 07 Ostrava - Radvanice Czech Republic	

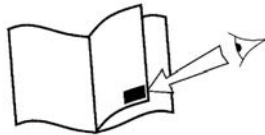

Veuillez lire la notice générale / Please read the general instructions / Leggere le istruzioni generali / Sivase leer el manual general / Bitte allgemeingültige anweisung lesen

49

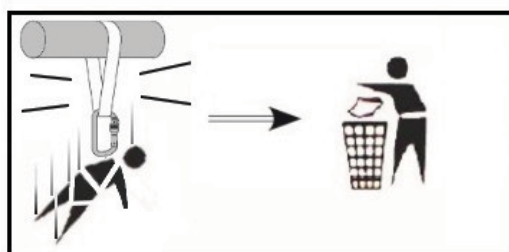
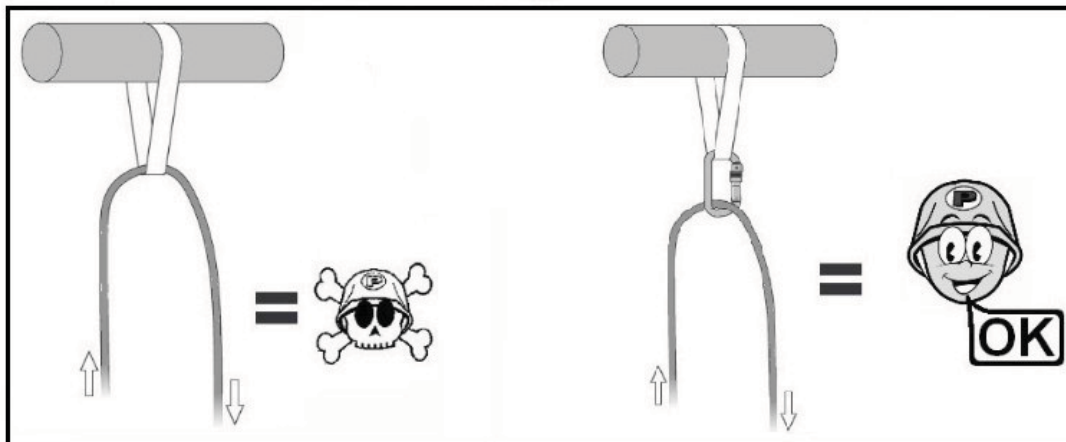
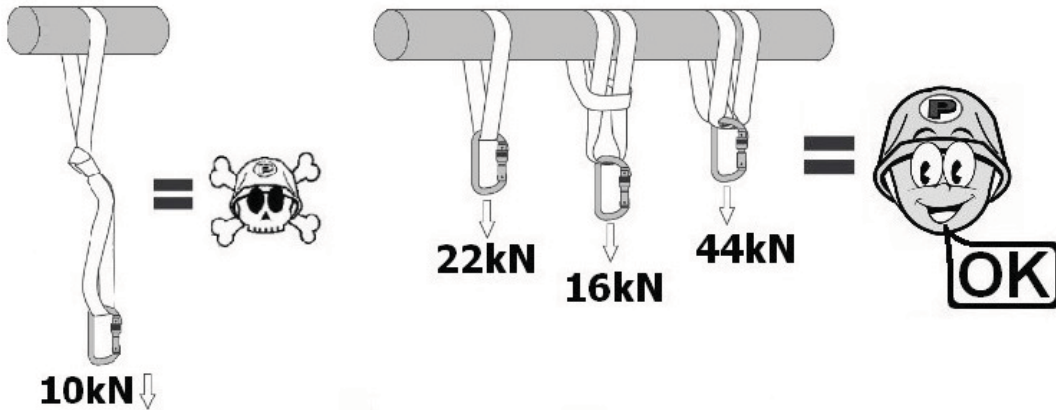

- FR:**
3 = Norme européenne
4 = Année de fabrication
5 = Mois de fabrication
6 = Numéro de série
7 = Numéro de lot
8 = Examen CE de type effectué par
9 = N°organisme controlant cet EPI
10 = Attention: lire la notice
11 = Longueur
29 = Résistance à la rupture
- EN:**
3 = European Standard
4 = Year of manufacture
5 = Month of manufacture
6 = Serial number
7 = Batch number
8 = EC test performed by
9 = Number of quality control Body
10 = Note: read the notice
11 = Length
29 = Breaking strength
- IT:**
3 = Norma europea
4 = Anno di fabbricazione
5 = Mese di fabbricazione
6 = Numero di serie
7 = Numero di lotto
8 = Esame CE del tipo effettuato da
9 = Numero dell'organismo di valutazione della conformità di questo EPI
10 = Attenzione: leggere le istruzioni
11 = Lunghezza
29 = Resistenza alla rottura
- ES:**
3 = Normativa europea
4 = año de fabricación
5 = Mes de fabricación
6 = Número de serie
7 = Número de lote
8 = Examen CE de tipo efectuado por
9 = Número del organismo que controla la fabricación de este EPI
10 = Cuidado: leer el manual
11 = Longitud
29 = Resistencia a la rotura
- DE:**
3 = Europäische Norm
4 = Baujahr
5 = Herstellungsmonat
6 = Serien-Nummer
7 = Cargen-Nummer
8 = CE-Typenprüfung durch
9 = Nummer der mit der Herstellungskontrolle dieser
10 = Achtung: Anweisung lesen
11 = Länge
29 = Bruchfestigkeit



**СПЕЦИАЛЬНАЯ
ИНСТРУКЦИЯ**

**АНКЕРНАЯ
ПЕТЛЯ**

AM450/80

EAC ГОСТ Р ЕН 795-2009 В
ТР ТС 019/2011

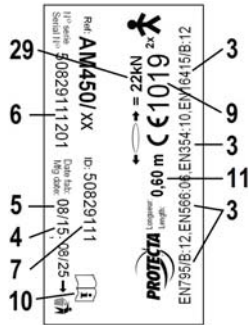

Длина 11
0,80 m

Застежка	Перевязь	Нить ткани
	Полиэстер	Полиамид

	+ 57°C - 35°C		0,085kg
--	------------------	--	---------

Год производства 4
2016

СЕРТИФИКАТ
СООТВЕТСТВИЯ CE 8
N°1019 :
VVUU a.s.
Pikartska 1377/7
716 07 Ostrava - Radvanice
Czech Republic

BATCH / ID 7

НОМЕР
ОРГАНИЗАЦИЯ 9
N°1019 :
VVUU a.s.
Pikartska 1377/7
716 07 Ostrava - Radvanice
Czech Republic

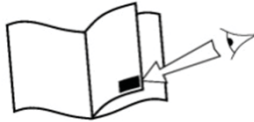

Пожалуйста общую инструкцию

3 = Европейский стандарт; 4 = Год производства; 5 = Месяц производства; 6 = Серийный номер; 7 = Номер лота; 8 = Сертификат соответствия CE;
9 = Номер организация, контролирующей производство данного изделия; 10 = Внимание: читайте инструкцию; 11 = Длина; 29 = Прочность на разрыв

