



# CYNCH-LOK

## Wood Pole Fall Restriction Device

Model Numbers: 1204057, 1204058, 1204075, 1204076

### **USER INSTRUCTION MANUAL: CYNCH-LOK™ WOOD POLE FALL RESTRICTION DEVICE**

*This manual is intended to meet the Manufacturer's Instructions requirement of applicable standards defined in Section 1.2 and should be used as part of an employee training program as required by the identified agencies.*

**WARNING:** This product is part of a personal fall restriction system. The user must read and follow the manufacturer's instructions for each component or part of the complete system. These instructions must be provided to the user of this equipment. The user must read and understand these instructions or have them explained to them before using this equipment. Manufacturer's instructions must be followed for proper use and maintenance of this product. Alterations or misuse of this product or failure to follow instructions may result in serious injury or death.

**IMPORTANT:** If you have questions on the use, care, or suitability of this equipment for your application, contact Capital Safety.

**IMPORTANT:** Record the product identification information from the ID label in the Inspection and Maintenance Log in Section 12.



#### **DESCRIPTION:**

Figure 1 illustrates DBI-Sala Cynch-Lok™ Wood Pole Fall Restriction Devices (WPFRD) that were developed by linemen for linemen. They are the most user friendly pole-climbing devices on the market that meet the stringent ASTM F887-11 and CSA Z259-14 standards. The patent-pending effortless adjustment is a "Cynch" to use and designed to "Cynch" around wood poles. When used correctly, the Cynch-Lok™ will reduce fall distances in accordance with ASTM and CSA standards. As your leader in fall protection, Capital Safety's goal is to offer linemen fall protection that is lightweight, easy to use, and built with the user in mind.

**Figure 1 - Fall Restricting Pole Strap**

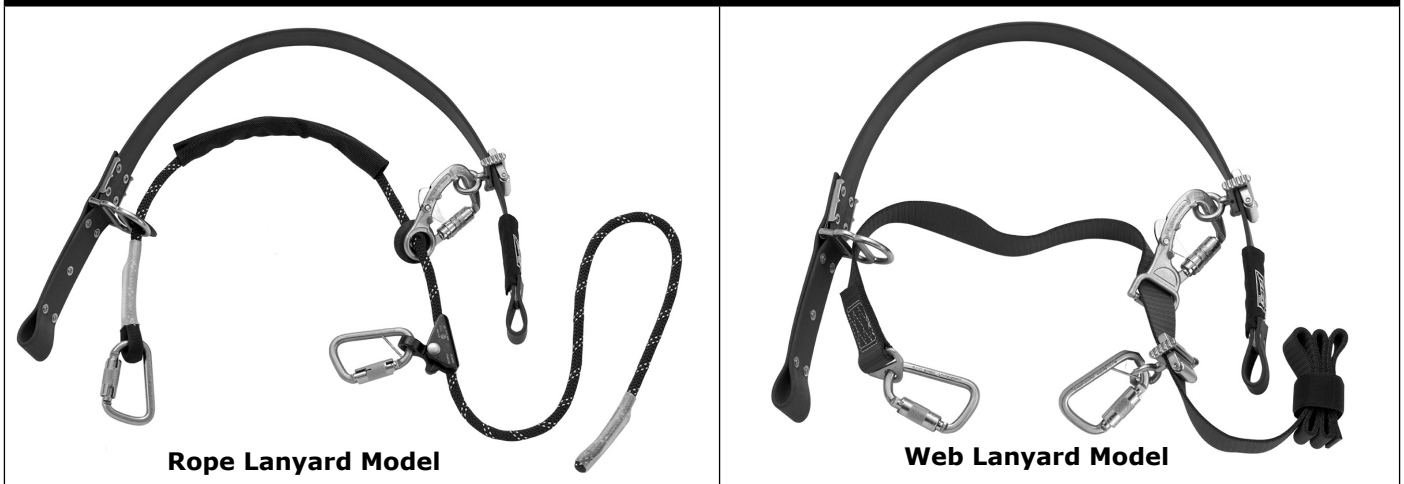

**Rope Lanyard Model**

**Web Lanyard Model**

## 1.0 APPLICATION

**1.1 PURPOSE:** The Cynch-Lok WPFRD is for use when climbing and working on wooden utility poles (power poles, telephone poles, etc.).

**1.2 STANDARDS:** Refer to the following standard on fall protection:

ASTM	F887-11	Standard Specifications For Personal Climbing Equipment	Type AB
CSA	Z259.14	Fall Restrict Equipment for Wood Pole Climbing	Type AB

**1.3 TRAINING:** This equipment is intended to be used by persons trained in its correct application and use. It is the responsibility of the user to assure they are familiar with these instructions and are trained in the correct care and use of this equipment. Users must also be aware of the operating characteristics, application limits, and the consequences of improper use.

## 2.0 SYSTEM LIMITATIONS & REQUIREMENTS

Consider the following limitations/requirements prior to installing or using this equipment:

**2.1 CAPACITY:** This equipment is designed for use by a one climber at a time. Combined weight of the climber (person, clothing, tools, etc.) should not exceed 350 lbs (158 kg).

**2.2 FALL CLEARANCE:** Ensure that adequate clearance exists in the fall path to prevent striking an object during a fall. The clearance required is dependent on the type of connecting subsystem (rope grab, lanyard), the anchorage location, and the elongation characteristics of the lanyard.

**2.3 ENVIRONMENTAL HAZARDS:** Use of this equipment in areas where environmental hazards exist may require additional precautions to reduce the possibility of injury to the user or damage to the equipment. Hazards may include, but are not limited to: high heat, caustic chemicals, corrosive environments, high voltage power lines, explosive or toxic gases, moving machinery, or sharp edges.

**2.4 COMPATIBILITY OF COMPONENTS:** Unless otherwise noted, Capital Safety equipment is designed for use with Capital Safety approved components and subsystems only. Substitutions or replacements made with non approved components or subsystems may jeopardize compatibility of equipment and may affect safety and reliability of the complete system.

**2.5 COMPATIBILITY OF CONNECTORS:** Connectors are considered to be compatible with connecting elements when they have been designed to work together in such a way that their sizes and shapes do not cause their gate mechanisms to inadvertently open regardless of how they become oriented. Connectors (hooks, carabiners, and D-rings) must be capable of supporting at least 5,000 lbs. (22 kN). Connectors must be compatible with the anchorage or other system components. Do not use equipment that is not compatible. Non-compatible connectors may unintentionally disengage (see Figure 2). Connectors must be compatible in size, shape, and strength.

**2.6 MAKING CONNECTIONS:** Use only self-locking snap hooks and carabiners with this equipment. Only use connectors that are suitable to each application. Ensure all connections are compatible in size, shape and strength. Do not use equipment that is not compatible. Ensure all connectors are fully closed and locked.

Capital Safety connectors (snap hooks and carabiners) are designed to be used only as specified in each product's user's instructions. See Figure 3 for illustration of the inappropriate connections stated below. Capital Safety snap hooks and carabiners should not be connected:

- A. To a D-ring to which another connector is attached.
- B. In a manner that would result in a load on the gate.
- C. In a false engagement, where features that protrude from the snap hook or carabiner catch on the anchor and without visual confirmation seems to be fully engaged to the anchor point.
- D. To each other.
- E. Directly to webbing or rope lanyard or tie-back (unless the manufacturer's instructions for both the lanyard and connector specifically allow such a connection).
- F. To any object which is shaped or dimensioned such that the snap hook or carabiner will not close and lock, or that roll-out could occur.
- G. In a manner that does not allow the connector to align with the fall arrest device (i.e., lanyard) while under load.

**NOTE:** Other than 3,600 lb. (16 kN) gated hooks, large throat opening snap hooks should not be connected to standard size D-rings or similar objects which will result in a load on the gate if the hook or D-ring twists or rotates. Large throat snap hooks are designed for use on fixed structural elements such as rebar or cross members that are not shaped in a way that can capture the gate of the hook.

**Figure 2 - Unintentional Disengagement (Rollout)**

If the connecting element to which a snap hook (shown) or carabiner attaches is undersized or irregular in shape, a situation could occur where the connecting element applies a force to the gate of the snap hook or carabiner. This force may cause the gate (of either a self-locking or a non-locking snap hook) to open, allowing the snap hook or carabiner to disengage from the connecting point.

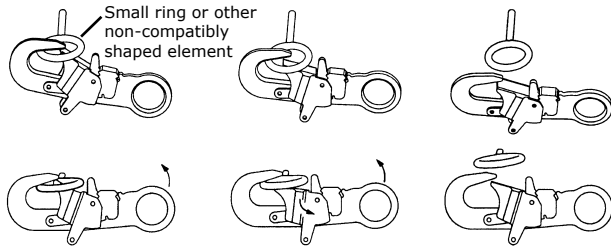

1. Force is applied to the Snap Hook.
2. The Gate presses against the Connecting Ring.
3. The Gate opens allowing the Snap Hook to slip off.

**2.7 FREE-FALL DISTANCE:** The free-fall distance of the Cynch-Lok WPFRD is approximately equal to the distance between the user and the pole under normal climbing conditions. To minimize free-fall distance, the user should always work as close to the pole as possible (See Table 2 for Normal Climbing Conditions).

**2.8 DECELERATION DISTANCE:** In many cases there is no deceleration distance of the Cynch-Lok WPFRD during a fall event; however, some deceleration distance may occur. Specific deceleration distances vary depending on pole conditions (dry, wet, conduit covered, icy, etc.). Table 2 describes the expected deceleration distance of the Cynch-Lok WPFRD based on physical test data.

**2.9 TOTAL-FALL DISTANCE:** The expected total fall distance (i.e. distance from the original anchorage point on the pole to the worker's waist belt location upon completion of fall restrict) is the sum of the expected free-fall distance and the expected slippage (See Table 1 for Expected Total Fall Distance).

**Figure 3 - Inappropriate Connections**

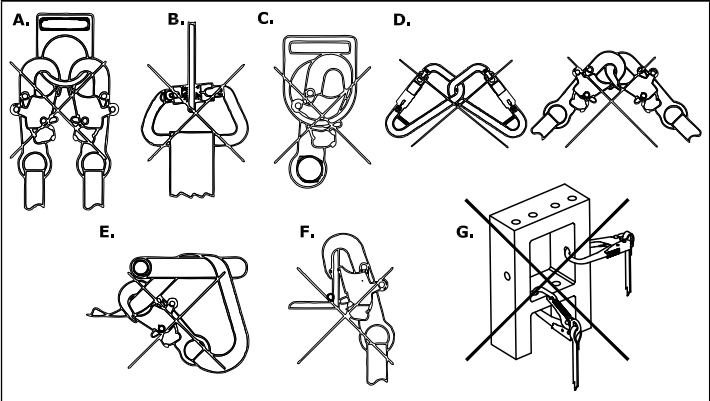
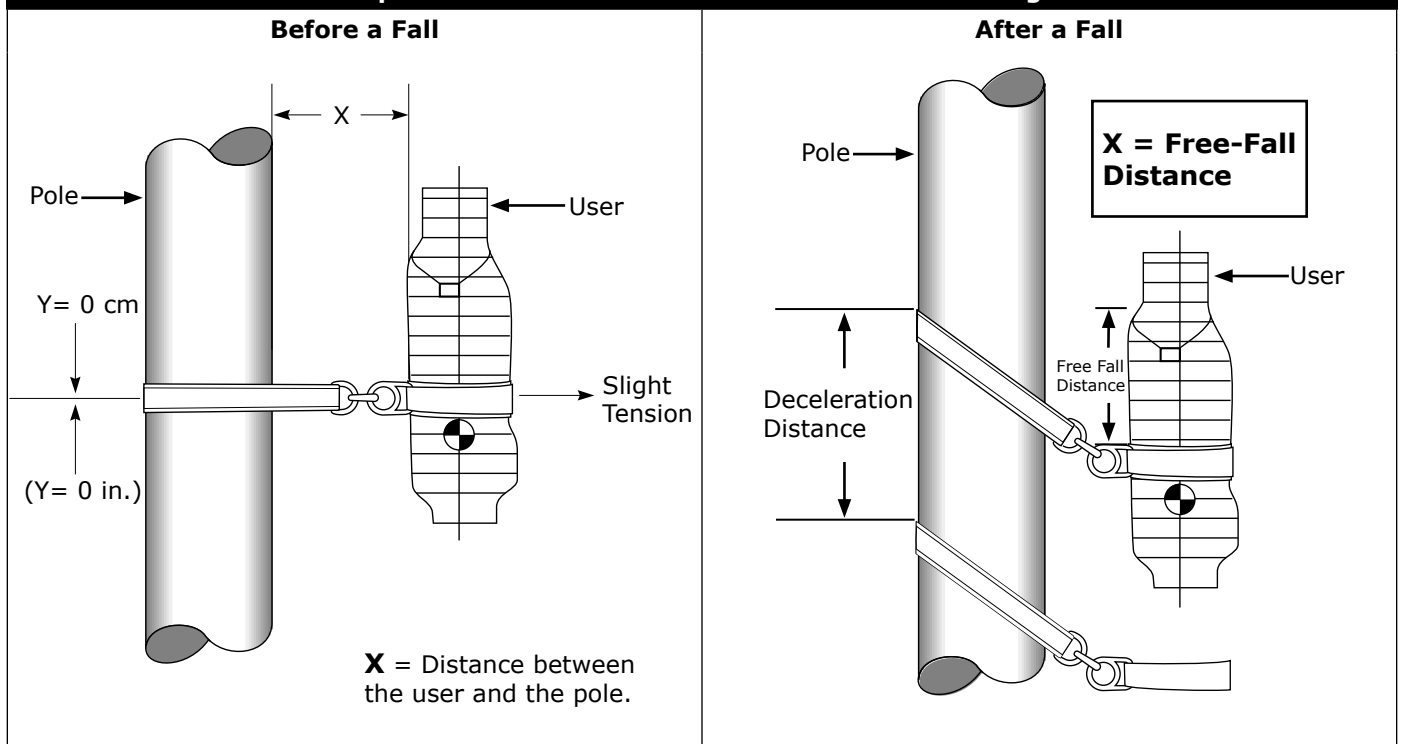

**Table 1 - Expected Total Fall Distance Under Normal Climbing Conditions**

	Dry Pole	Wet Pole	Icy Pole
Free-Fall Distance	30.5 cm (12 in)	30.5 cm (12 in)	30.5 cm (12 in)
Deceleration Distance	8 cm (3.2 in)	63 cm (24.8 in)	44 cm (17.3 in)
Total Fall Distance	38.5 cm (15.2 in)	93.5 cm (36.8 in)	74.5 cm (29.3 in)

**NOTE:** All test data shown in Table 1 is based on results obtained during ASTM and CSA compliance testing in accordance with ASTM standard F887-11 and CSA standard Z259.14. Actual distances may vary depending on climbing conditions.

**Table 2 - Expected Free-Fall Distance Under Normal Climbing Conditions**



### 3.0 SYSTEM INSTALLATION

**3.1 PLANNING:** Consider all limitations and requirements defined in Section 2 and the following logistical aspects before using the Cynch-Lok WPF RD:

- A. POLE INTEGRITY:** Inspect and secure an unsound pole so it is safe for climbing.
- B. SHARP EDGES:** Avoid working where the Cynch-Lok and attached subsystems will contact or abrade against unprotected sharp edges. If working with the Cynch-Lok around sharp edges is unavoidable, apply a heavy pad over the exposed sharp edge.
- C. CLIMBING PATH:** Identify the best climbing path prior to using the Cynch-Lok WPF RD.
- D. GENERAL USE CONSIDERATIONS:** Avoid working where your Cynch-Lok WPF RD may cross or tangle with that of another worker. Do not allow your Cynch-Lok WPF RD to pass under your arms or tangle in your feet. Follow *Live Line* procedures when working around exposed live components.
- E. RESCUE:** The employer should always have a Rescue Plan in place and the ability to readily implement the plan.

### 4.0 SYSTEM COMPONENTS

#### 4.1 MODELS:

<b>Distribution Model - Rope: 1204057</b> Minimum Pole Circumference--17.5 in. (44.45 cm) Minimum Pole Diameter--5.5 in. (14 cm) Maximum Pole Circumference--58 in. (147 cm) Maximum Pole Diameter--18.5 in. (47 cm)	(A) 1200110	◇ Cynch-Lok component parts are available for purchase individually as replacement parts.  ◇ Part numbers 1200110 and 1200111 can be purchased individually and interchanged with part number 1200115 or part number 1200136 or different diameter poles.  ◇ 1200110 (A) refers to the Distribution Strap (Figure 4)  ◇ 1200111 (B) refers to the Transmission Strap (Figure 5)  ◇ 1200115 (C) refers to the Adjustable Rope Lanyard (Figure 6)  ◇ 1200136 (D) refers to the Adjustable Web Lanyard (Figure 7)
	(C) 1200115	
<b>Transmission Model - Rope: 1204058</b> Minimum Pole Circumference--17.5 in. (44.45 cm) Minimum Pole Diameter--5.5 in. (14 cm) Maximum Pole Circumference--96 in. (244 cm) Maximum Pole Diameter--30.5 in. (77.5 cm)	(B) 1200111	
	(C) 1200115	
<b>Distribution Model - Web: 1204075</b> Minimum Pole Circumference--17.5 in. (44.45 cm) Minimum Pole Diameter--5.5 in. (14 cm) Maximum Pole Circumference--58 in. (147 cm) Maximum Pole Diameter--18.5 in. (47 cm)	(A) 1200110	
	(D) 1200136	
<b>Transmission Model - Web: 1204076</b> Minimum Pole Circumference--17.5 in. (44.45 cm) Minimum Pole Diameter--5.5 in. (14 cm) Maximum Pole Circumference--96 in. (244 cm) Maximum Pole Diameter--30.5 in. (77.5 cm)	(B) 1200111	
	(D) 1200136	

#### 4.2 COMPONENTS

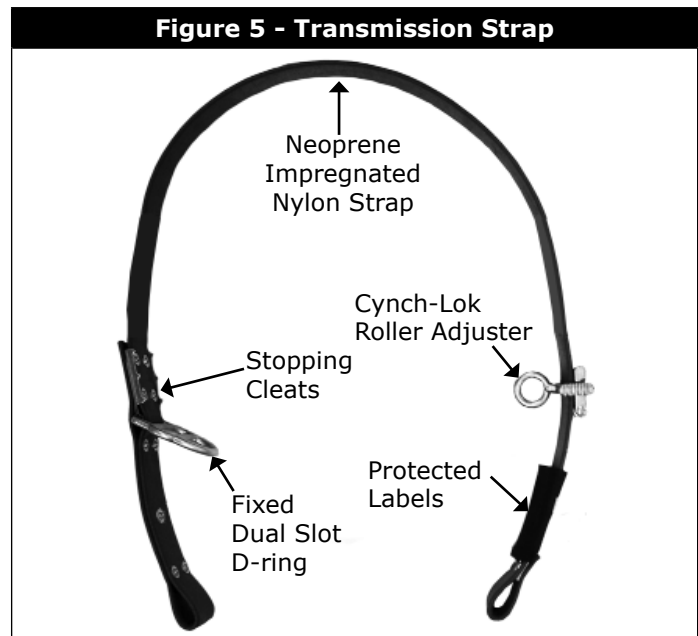
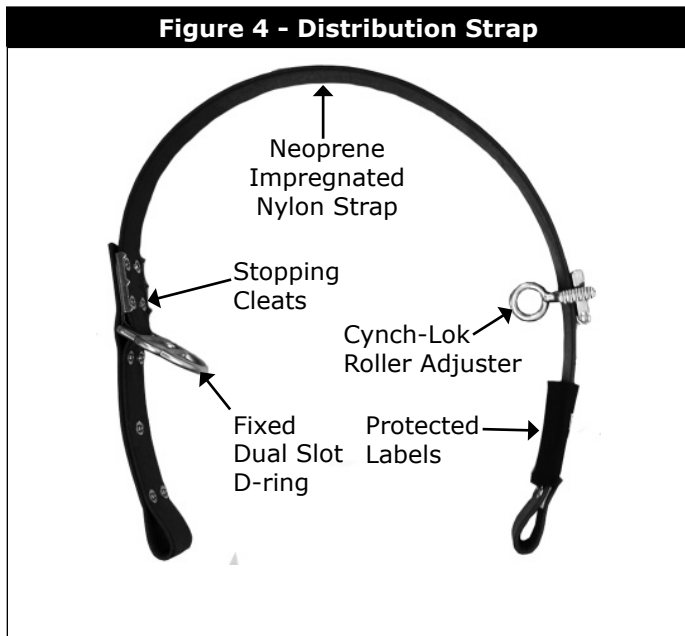

**Figure 6 - Adjustable Rope Lanyard**

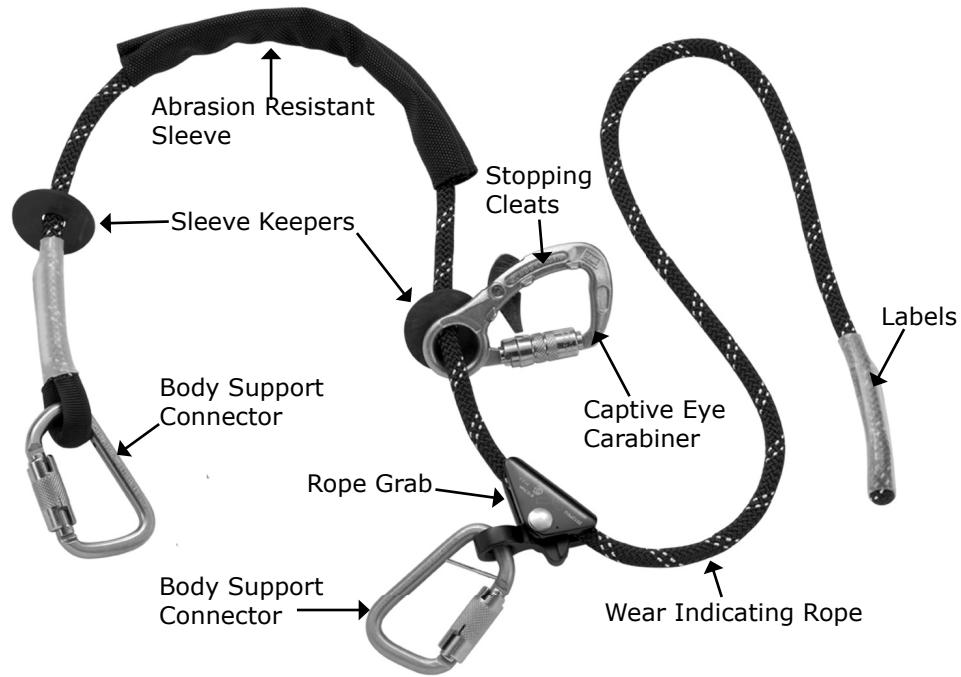

**Figure 7 - Adjustable Web Lanyard**

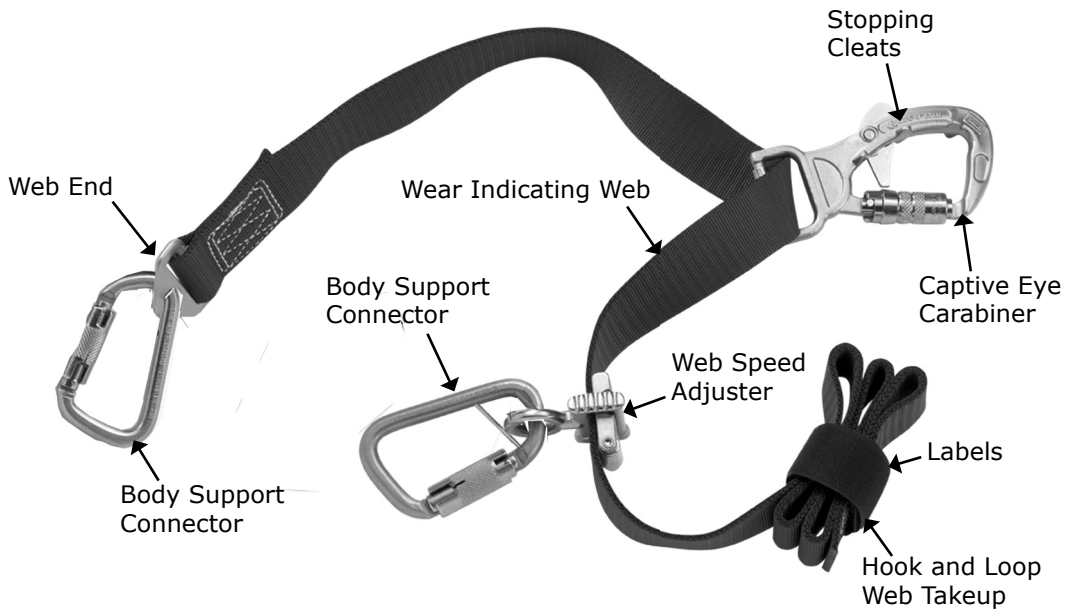

## 5.0 INSPECTION

### 5.1 FREQUENCY:

- **Before Each Use:** Visually inspect all components of the Cynch-Lok WPFRD per the guidelines defined in Section 5.2. Check the labels on the Rope or Web Lanyard, Transmission Pole Strap and Distribution Pole Strap to verify that the annual inspection is current. If the condition of any component in the system is in doubt, do not use.
- **Annual Inspection:** A formal inspection of all components comprising the Cynch-Lok WPFRD must be performed at least annually by a Competent Person<sup>1</sup> other than the user.
- **After a Fall:** If a fall occurs while using the Cynch-Lok WPFRD, a formal inspection of the entire system must be performed by a competent person other than the user.

**1 Competent Person:** An individual knowledgeable of a manufacturer's recommendations, instructions, and manufactured components who is capable of identifying existing and predictable hazards in the proper selection, use, and maintenance of fall protection equipment.

**5.2 INSPECTION GUIDELINES:** To ensure safe efficient operation, components of the Cynch-Lok WPF RD should be inspected per the following guidelines:

<b>Parts to Inspect:</b>		<b>Before Each Use</b>	<b>Every Year</b>	<b>After a Fall</b>
<b>Adjustable Lanyard</b>				
Abrasion Resistant Sleeve (Rope model only)	Verify there are no tears, rips, or holes in material	X	X	X
Body Support Connector	Verify the connector moves freely and the locking mechanism works properly	X	X	X
Captive Eye Carabiner	Verify the carabiner moves freely and the locking mechanism works properly	X	X	X
Labels	Verify labels are attached and legible	X	X	X
Rope Grab (Rope model only)	Verify the cam moves freely, grips the rope securely, and there is no wear in the rope guide	X	X	X
Sleeve Keepers (Rope model only)	Verify there are no cuts, frays, and there is no visible wear	X	X	X
Wear Indicating Rope (Rope model only)	Verify that the inner core (light tan color) is not visible and that there are no tears or rips in the navy blue cover.	X	X	X
Web Speed Adjuster (Web model only)	Verify the web speed adjuster moves freely and grips the web securely.	X	X	X
Web End (Web model only)	Verify the web end is fixed in place and there are no visible cracks or wear	X	X	X
Web Lanyard	Verify there are no cuts, frays, and there is no visible wear.	X	X	X
<b>Distribution Strap</b>				
Cynch-Lok Roller Adjuster	Verify the adjuster moves freely, locks the strap into place when pressure is applied, and is free of dirt and debris	X	X	X
Fixed Dual Slot D-Ring	Verify the dual slot D-Ring is fixed in place and there are no visible cracks or wear	X	X	X
Neoprene Impregnated Nylon Strap	Verify there is no wear, tears, or cuts Verify the red fabric that indicators wear is not visible	X	X	X
Stopping Cleat	Verify the cleat is mounted securely with no cracks, chips, or missing cleats	X	X	X
Labels	Verify labels are attached and legible	X	X	X
<b>Transmission Strap</b>				
Cynch-Lok Roller Adjuster	Verify the adjuster moves freely, locks the strap into place when pressure is applied, and is free of dirt and debris	X	X	X
Fixed Dual Slot D-Ring	Verify the dual slot D-Ring is fixed in place and there are no visible cracks or wear	X	X	X
Neoprene Impregnated Nylon Strap	Verify there is no wear, tears, or cuts Verify the red fabric that indicators wear is not visible	X	X	X
Stopping Cleat	Verify the cleat is mounted securely with no cracks, chips, or missing cleats	X	X	X
Labels	Verify labels are attached and legible	X	X	X

**5.3 INSPECTION RECORDS:** After each inspection, record the inspection date and results in the Inspection & Maintenance Log (Section 12).

**5.4 UNSAFE OR DEFECTIVE CONDITIONS:** If inspection reveals an unsafe or defective condition in a component of the Cynch-Lok WPF RD, remove the component from service and destroy it or contact an authorized service center for repair.

## 6.0 OPERATION AND USE

### 6.1 CONNECTING TO THE BODY SUPPORT

**IMPORTANT:** The user must utilize a properly sized body belt or full body harness with side positioning D-Rings.

**Step 1:** Attach the Body Support Connectors to the side positioning D-Rings so that the connector gates are facing outward. (Figure 8)

**Step 2:** Ensure the rope or web grab is lying flat with the excess trailing out to the user's side. (Figure 8)

**Figure 8 - Connect to Body Support**



**Rope Model**



**Web Model**

**6.2 STORAGE OF UNUSED LANYARD ROPE OR WEBBING:** The adjustable rope lanyard and adjustable web lanyard include a sewn loop near the labels (see Figures 6 & 7). This loop can be used to aid in the storage of unused lanyard rope or webbing and must not be connected to body support carabiners or other load bearing connectors. Only use this loop with breakaway style non-load bearing belt hooks, clips, and keepers (see Figure 9 for example of proper connection to breakaway belt hook).

**Figure 9 - Rope or Web Storage**



### 6.3 CONNECT TO POLE:

With the captive eye carabiner disconnected from the Cynch-Lok adjuster, wrap the external Cynch-Lok strap around the pole and connect to the eye of the Cynch-Lok adjuster. (Figure 10)

**IMPORTANT:** Make sure there are no twists, turns, or knots, in the internal lanyard and that it is passing through the correct D-Ring slot. (Figure 11)

**Figure 10 - Connect to Pole**



**Figure 11 - No Twists, Turns or Knots in Lanyard**



**Rope Model**



**Web Model**

#### **6.4 PROPER STOPPING CLEAT ADJUSTMENT**

Keeping the stopping cleats adjusted properly is necessary to ensure the Cynch-Lok performs safely and effectively.

**IMPORTANT:** Remember the circumference of a pole decreases towards the top; therefore, the stopping cleats need to be continuously readjusted to ensure they remain in the correct position while ascending and descending. Also, if obstructions such as conduit, cable, etc. inhibit the stopping cleats from contacting the pole, readjustment is required.

**Step 1:** With the Cynch-Lok connected to the body belt D-Rings, lean back and take all the slack out of the device.

#### **CLIMBING ADJUSTMENT**

**Step 2:** Slide the adjuster forward and position the device so the **center** stopping cleats on each side are in a position that will contact the pole when tension is applied to the internal lanyard. (Figure 12)

**Figure 12 - Stopping-Cleat Adjustment**



**Rope Model**



**Web Model**

**IMPORTANT:** If the center stopping cleats do not contact the pole when tension is applied to the internal lanyard the cleats **must** be adjusted forward until contact is made. (Figure 13)



**Figure 13 - Climbing Cleat Adjustment**

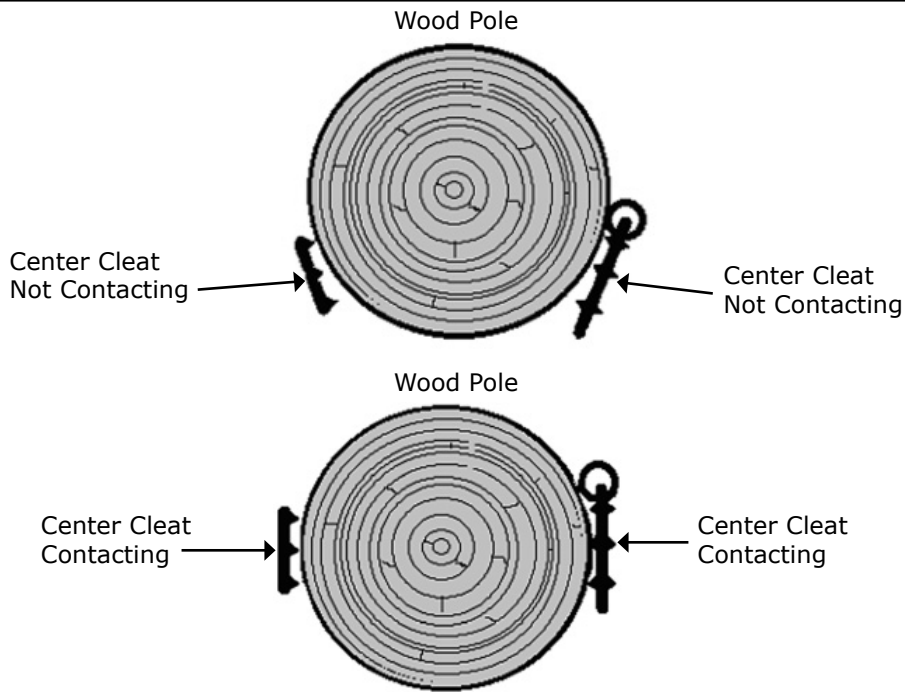

**WORK POSITIONING CLEAT ADJUSTMENT**

When working aloft, move the adjuster until the rear stopping cleats on each side are in contact with the pole. (Figure 14)

**Figure 14 - Work Positioning Cleat Adjustment**

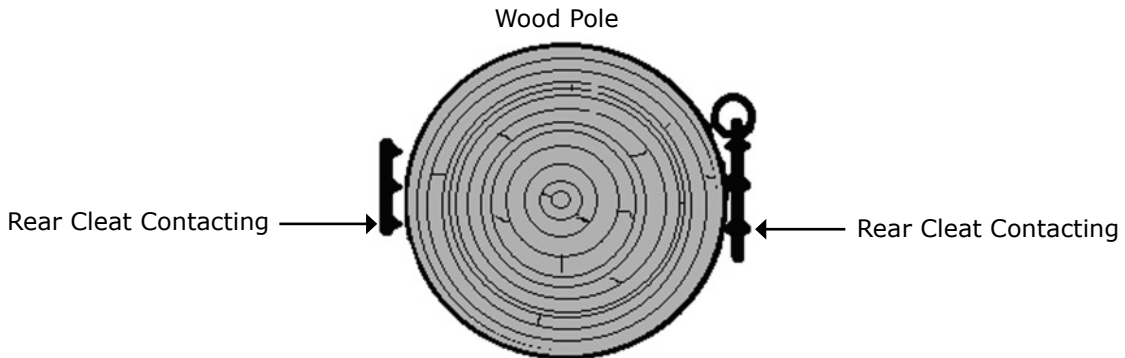

**NOTE:** Adjusting the rear stopping cleats to contact the pole reduces the pinching effect on the climber's hips and also helps to secure the device in place while working with both hands free.

**ICY OR SLIPPERY POLE CLIMBING ADJUSTMENT**

On icy or slippery poles, always insure that the rear stopping cleats contact the back side of the pole and **never allow them to move forward of the center line.** (Figure 15)

**Figure 15 - Climbing Cleat Adjustment; Icy or Slippery Pole**

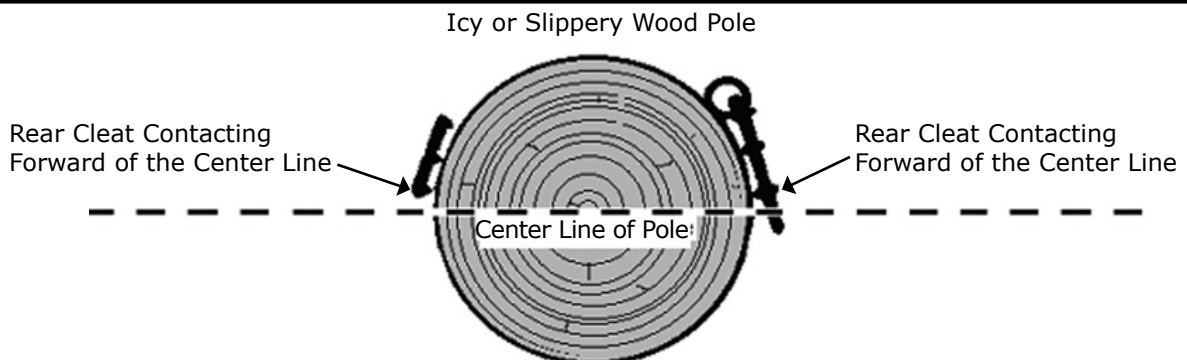

**IMPORTANT:** Due to the variety of climbing conditions that can be encountered when using the Cynch-Lok, the term "slippery pole" includes but is not limited to: grease or oil covered poles, pitch covered poles, moss covered poles and foliage covered poles. Also, the age, moisture content, and condition of a pole can affect its interaction with wood pole fall restriction devices. If the condition of a pole is in question the icy or slippery pole cleat adjustment must be used.

## 6.5 SLIDING THE ADJUSTER FORWARD

### **One Handed:**

- Step 1:** Place your hand on the exterior strap against the back of the pole.  
(Figure 16)
- Step 2:** Pull your body forward to take tension off the interior lanyard.
- Step 3:** Push the strap out and around towards the back side of the pole.

**Figure 16 - One-Handed**



### **One Handed Without Stopping:**

- Step 1:** Hold the brown strap with one hand behind the D-Ring and the other directly behind the Cynch-Lok Roller Adjuster.  
(Figure 17)
- Step 2:** Pull your body forward to create slack in the internal lanyard
- Step 3:** Push the adjuster side of the strap out and around towards the back side of the pole.

**Figure 17 - One-Handed Without Stopping**



**Two Handed:**

- Step 1:** With your hands on the brown strap, pull your body forward to create slack in the internal lanyard. (Figure 18)
- Step 2:** Shift the strap a quarter turn and hold the adjuster eye close to your body.
- Step 3:** While holding your body weight forward with one hand, push the adjuster into position with the other. (Figure 19)

**Figure 18 - Two-Handed Adjustment**



**Figure 19 - Two-Handed Adjustment**



**6.6 SLIDING THE ADJUSTER BACK OUT**

- Step 1:** Holding the exterior Cynch-Lok strap with one hand behind the D-Ring and the other on the strap behind the adjuster with your thumb and index finger on the adjuster body, pull your body forward to create slack in the interior lanyard. Pull the adjuster back. (Figure 20)

**Tip:** Just slightly, pull the adjuster eye away from the pole until it is no longer touching and it will move back effortlessly. You only need a small gap.

**Figure 20 - Slide Adjuster Back Out**



**6.7 ADJUSTING YOUR BODY FROM THE POLE**

**Adjusting Out From the Pole (Rope Version)**

- Step 1:** Place your hand behind the pole and pull your body forward to create a small amount of slack in the interior rope lanyard.
- Step 2:** With your thumb on the eye of the rope grab and your fingers under the body of the rope grab; pinch and rotate the mechanism forward.
- Step 3:** While holding the rope grab forward, slowly lean your hips out away from the pole and release the rope grab when you are at a comfortable distance from the pole.

**Tip:** Keeping a small amount of pressure against the device helps keep it in position.

### Adjusting Forward into the Pole (Rope Version)

**Step 1:** Place your hand behind the pole and pull your body forward while you pull the excess slack out of the rope. (Figure 21)

**Tip:** Pull the slack directly at the pole.

Figure 21 - Adjust Forward into Pole, Rope Version



### Adjusting Out From the Pole (Web Version)

**Step 1:** Place your hand behind the pole and pull your body forward to create a small amount of slack in the interior web lanyard. (Figure 22)

**Step 2:** Using your thumb and middle finger, pull the Web Speed Adjuster back to a 90 degree angle and hold while slowly leaning back out away from the pole.

**Step 3:** Release the Web Speed Adjuster when you are at a comfortable distance from the pole.

**NOTE:** Operating the Web Speed Adjuster is similar to the Cynch-Lok Strap Roller Adjuster and will lock onto the web when tension is applied.

Figure 22 - Adjust Out from Pole, Web Version



### Adjusting Forward into the Pole (Web Version)

**Step 1:** Place your hand behind the pole and pull your body forward while you pull the excess slack out of the Web Speed Adjuster. (Figure 23)

**Tip:** Pull the slack directly at the pole.

Figure 23 - Adjust Forward into Pole, Web Version



## 6.8 CLIMBING

**WARNING:** Never place your hand inside the captive eye carabiner. Holding the carabiner during a fall is extremely dangerous because it prevents the stopping cleats from contacting the pole. (Figure 24) Always keep both hands on the exterior Cynch-Lok strap when climbing.

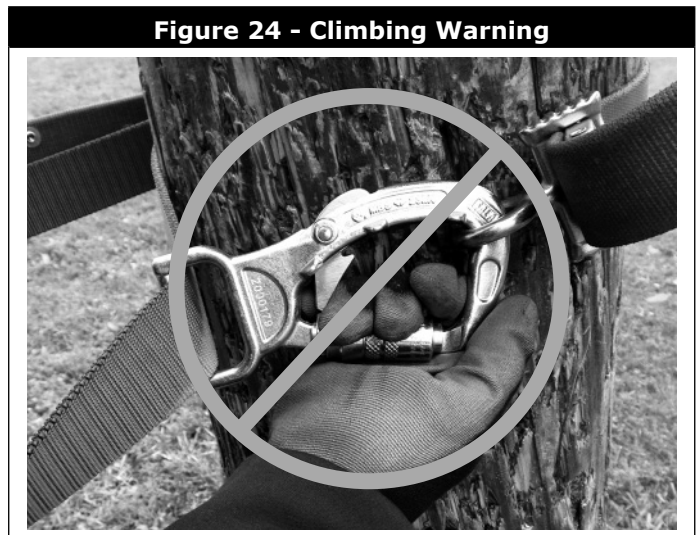

### 6.8.1 CLIMBING UP

**Step 1:** Hold the exterior Cynch-Lok strap with one hand placed behind the D-Ring and the other placed directly behind the adjuster. (Figure 25)

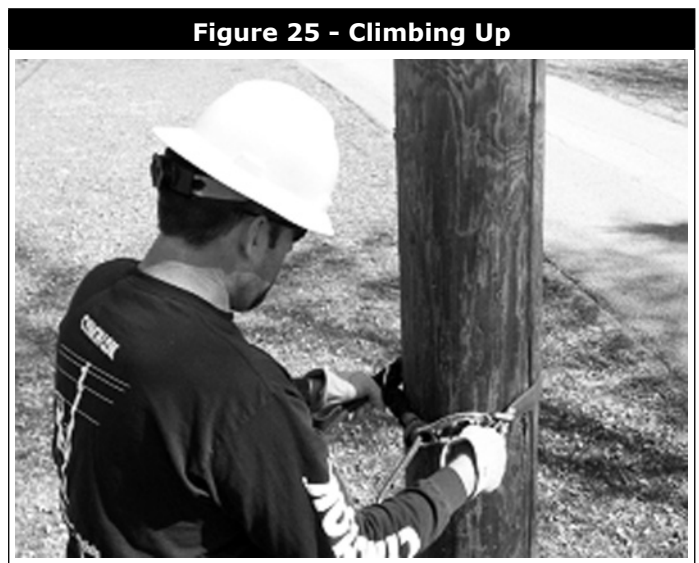

**Step 2:** Pull and hold your body forward to create slack in the interior lanyard. Using only your wrists, flip the strap up while climbing. (Figure 26)

**Tip 1:** The closer your body is to the pole the easier climbing will be.

**Tip 2:** Avoid dragging or jerking the strap up the pole. Slowly and smoothly place the strap in intervals as high as comfortably possible.

**IMPORTANT:** The cleats will need to be kept in proper adjustment as the pole diameter decreases. This can be done using the one handed adjustment method without stopping.

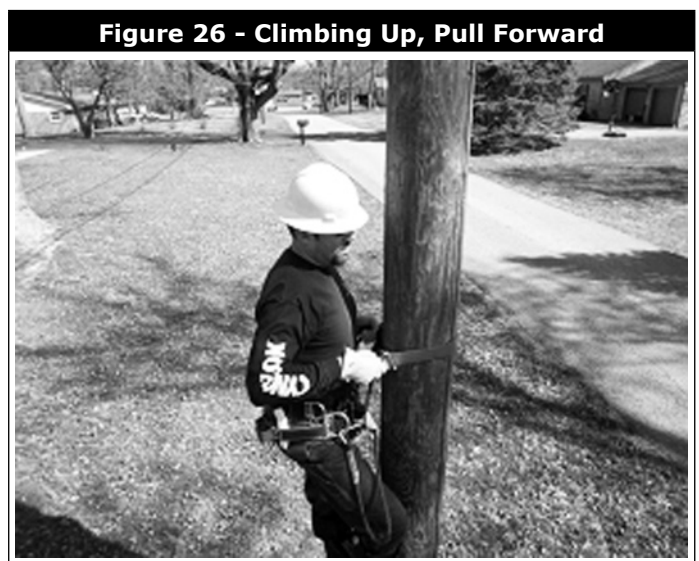

## 6.8.2 CLIMBING DOWN

**Step 1:** Hold the exterior Cynch-Lok strap with one hand placed behind the D-Ring and the other placed behind the adjuster with your thumb and index finger on the adjuster body. (Figure 27)

**Step 2:** Pull your body forward to create slack in the interior lanyard and place the strap as low a possible between descending steps.

**Tip:** By holding the strap and the adjuster at the same time, the Cynch-Lok can be adjuster out without stopping during the descent.

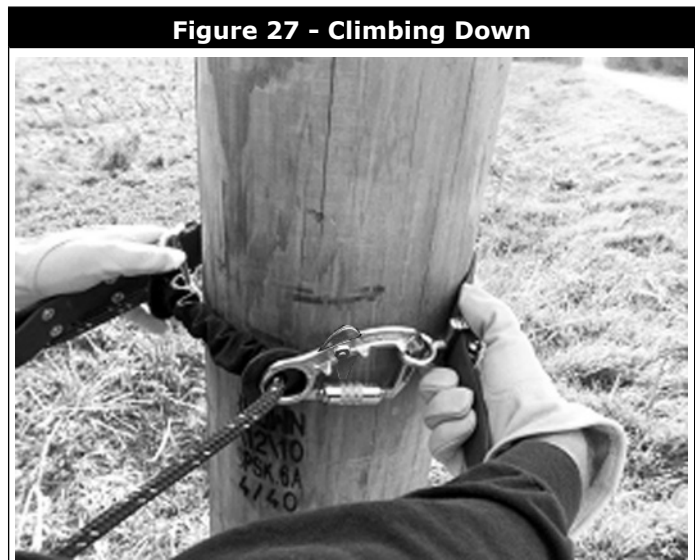

## 6.9 CROSSING OVER OBSTRUCTIONS

**IMPORTANT:** When crossing obstructions, the use of a secondary work positioning strap or lanyard is required to maintain 100% fall protection. Always make certain the secondary work positioning strap or lanyard is placed over a suitable obstruction that is capable of supporting the load of both user and equipment in the event of a fall.

**Step 1:** After reaching the obstruction, place a secondary work positioning strap or lanyard over the obstruction, making sure the secondary work positioning strap or lanyard is securely connected to both D-Rings of the body belt or full body harness. (Figure 28)

**IMPORTANT:** Never get into a position that will allow a free fall of more than **two feet** when using a secondary work positioning strap or lanyard.

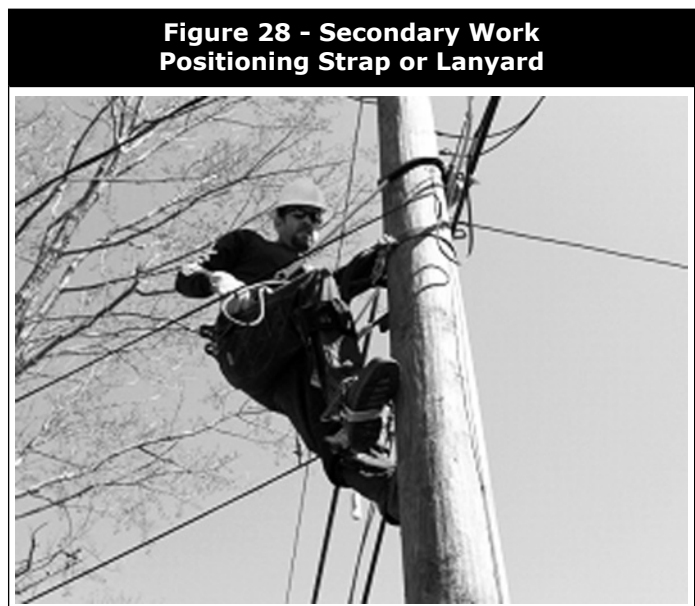

**Step 2:** After verifying the secondary work positioning strap or lanyard is secured over a suitable obstruction, disconnect the Cynch-Lok from the pole in accordance with section 6.2.

**Step 3:** Feed the Cynch-Lok up through the secondary work positioning strap or lanyard and reconnect it to the pole above the obstruction in accordance with section 6.2. (Figure 29)

**Step 4:** Properly adjust the Cynch-Lok to the pole in accordance with section 6.3.

**Step 5:** Disconnect the secondary positioning lanyard and store in a location that will not interfere with the Cynch-Lok.

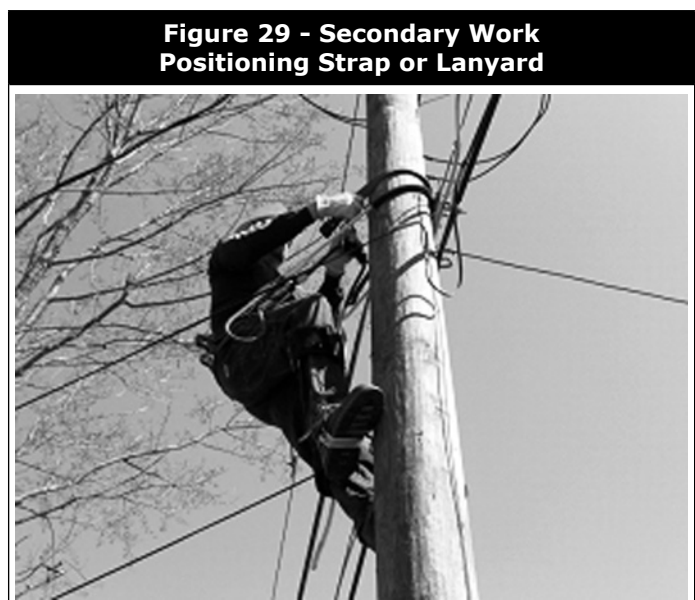



## 6.10 DESCENDING BELOW OBSTRUCTIONS

**Step 1:** After reaching the obstruction, place a secondary work positioning strap or lanyard over the obstruction, making sure the secondary work positioning strap or lanyard is securely connected to both D-Rings of the body belt or full body harness. (Figure 30)

**Step 2:** After verifying the secondary work positioning strap or lanyard is secured **over** a suitable obstruction, disconnect the Cynch-Lok from the pole in accordance with section 6.2.

**Step 3:** Feed the Cynch-Lok down through the secondary work positioning strap or lanyard and reconnect it to the pole below the obstruction in accordance with section 6.2. (Figure 31)

**Step 4:** Properly adjust the Cynch-Lok to the pole in accordance with section 6.3.

**Step 5:** Disconnect the secondary positioning lanyard and store in a location that will not interfere with the Cynch-Lok.

**Figure 30 - Descending Below Obstructions**



**Figure 31 - Reconnect Strap or Lanyard**



## 7.0 PROCEDURE TO CHANGE STRAP TYPE OR TO CHANGE INTERIOR LANYARD

**NOTE:** This procedure is used to change the strap type (Distribution or Transmission strap) or to change the interior lanyard (rope or web lanyard). Only Cynch-Lok straps with the dual slotted D-Ring can accept the adjustable web lanyard.

### 7.1 DISCONNECT THE DISTRIBUTION OR TRANSMISSION STRAP

#### Step 1: Rope Model

**Figure 32 - Disconnect Body Support Carabiner from the Rope Lanyard**



#### Web Model

**Figure 33 - Disconnect Body Support Carabiner from the Web Lanyard**



**Step 2:**

**Figure 34 - Pull Rope Lanyard through the Dual Slot D-Ring**

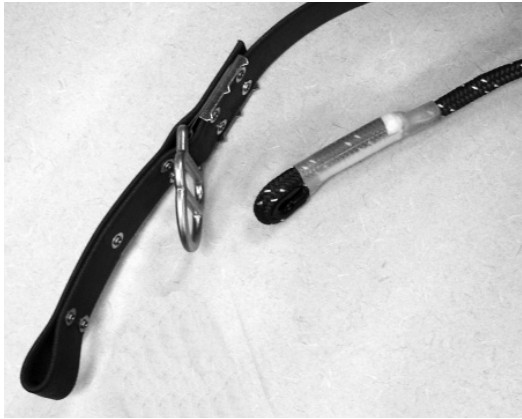

**Figure 35 - Pull Web Lanyard through the Dual Slot D-Ring**



**Step 3:**

**Figure 36 - Rope or Web Lanyard , Disconnect Captive Eye Carabiner from Cynch-Lok Roller Adjuster**



**Step 4: Remove the Distribution or Transmission strap.**

**7.2 ATTACH THE DISTRIBUTION OR TRANSMISSION STRAP**

**Step 1: Rope Model**

**Figure 37 - Insert Rope Lanyard Through Fixed Dual Slot D-Ring**

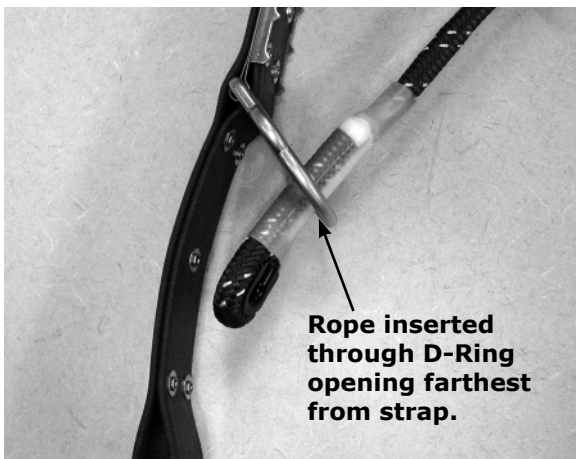

**Web Model**

**Figure 38 - Insert Web Lanyard Through Fixed Dual Slot D-Ring**





**Step 2: Rope Model**

**Figure 39 - Connect Body Support Carabiner to Rope Lanyard**



**Web Model**

**Figure 40 - Connect Body Support Carabiner to Web End**



**Step 3:**

**Figure 41 - Support Carabiner Properly Attached to Rope Lanyard**



**Figure 42 - Support Carabiner Properly Attached to Web Lanyard**



**Step 4:**

**Figure 43 - Web or Rope Model, Connect Captive Eye Carabiner to Cynch-Lok Roller Adjuster**



**Step 5: Rope Model**

**Figure 44 - Adjustable Rope Lanyard Properly Attached to a Distribution Strap or Transmission Strap for Right Hand Use**



**NOTE:** Before use, make sure there are no knots in the Rope Lanyard and that it is in the proper orientation as shown in Figure 44.

**Web Model**

**Figure 45 - Adjustable Web Lanyard Properly Attached to a Distribution Strap or Transmission Strap for Right Hand Use**



**NOTE:** Before use, make sure there are no twists in the Web Lanyard and that it is in the proper orientation as shown in Figure 45.

**8.0 PROCEDURE TO CONVERT CYNCH-LOK FROM RIGHT HAND TO LEFT HAND CONFIGURATION**

**NOTE:** This procedure is used to convert the Cynch-Lok from a right hand configuration to a configuration that supports left hand operation. Carabiner model 1204074 is required for left hand Rope Lanyard conversion. Carabiner model 1204077 is required for left hand Web Lanyard conversion.

**Step 1: Rope Model**

**Figure 46 - Disconnect Body Support Carabiner from the Rope Lanyard**

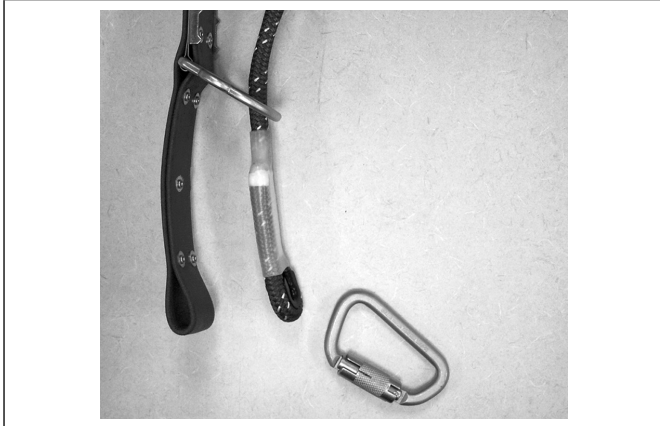

**Web Model**

**Figure 47 - Disconnect Body Support Carabiner from the Web Lanyard**



**Step 2: Rope Model**

**Figure 48 - Pull Rope Lanyard through the Dual Slot D-Ring**

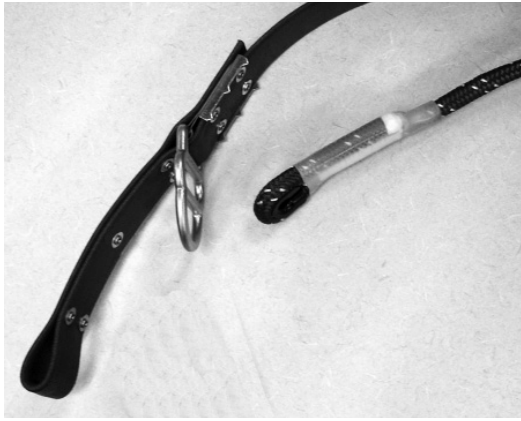

**Web Model**

**Figure 49 - Pull Web Lanyard through the Dual Slot D-Ring**



**Step 3:**

**Figure 50 - Rope or Web Lanyard , Disconnect Captive Eye Carabiner from Cynch-Lok Roller Adjuster**



**Step 4: Rope Model**

**Figure 51 - Remove Captive Eye Carabiner from Rope Lanyard**



**Note:** Sewn web loop will need to be compressed slightly to allow it to pass through the carabiner eye. Sleeve keepers and abrasion resistant sleeve must also be passed through the carabiner eye.

**Web Model**

**Figure 52 - Remove Captive Eye Carabiner from Web Lanyard**



**Note:** Rotate web end slightly to allow it to pass through the carabiner opening.

**Step 5:**

**Figure 53 - Rope or Web Lanyard, Flip the strap over so that the Cynch-Lok Roller Adjuster is on the left side**



**Step 6: Rope Model**

**Figure 54 - Insert Rope Lanyard into Captive Eye Carabiner (Model 1204074)**

Insert rope, sleeve keepers and abrasion resistant sleeve through the Captive Eye Carabiner until the carabiner reaches the rope grab.

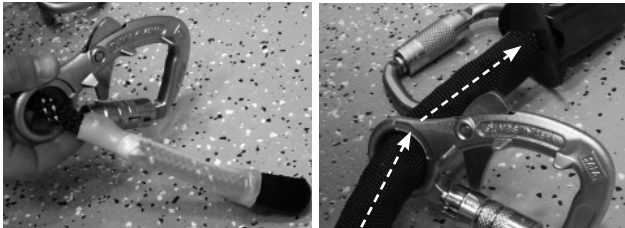

**Note:** Sewn web loop will need to be compressed slightly to allow it to pass through the carabiner eye.



**Web Model**

**Figure 55 - Insert Web Lanyard into Captive Eye Carabiner (Model 1204077)**



**Note:** Rotate web end slightly to allow it to pass through the carabiner opening.

**Step 7:**

**Figure 56 - Web or Rope Model, Attach Captive Eye Carabiner to Cynch-Lok Roller Adjuster**



**Step 8: Rope Model**

**Figure 57 - Insert Rope Lanyard through Fixed Dual Slot D-Ring**

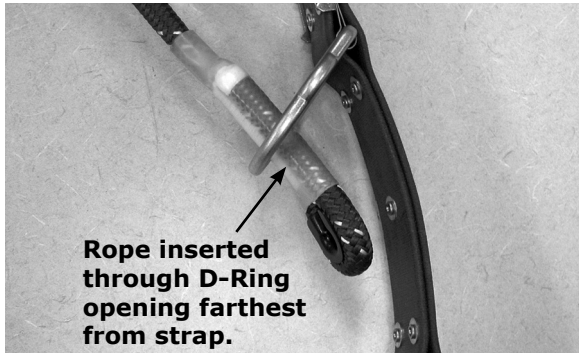

**Step 9:**

**Figure 59 - Connect Body Support Carabiner to Rope Lanyard**

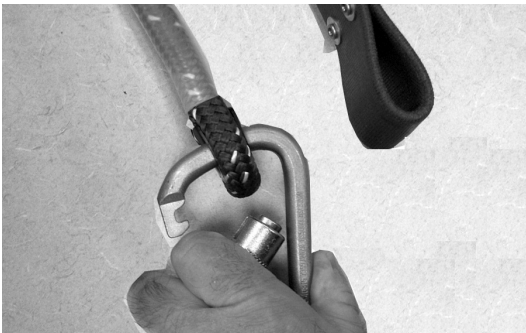

**Step 10:**

**Figure 61 - Right to Left Conversion Completed. Properly Attached to a Distribution Strap or Transmission Strap for Left Hand Use**



**NOTE:** Before use, make sure there are no knots in the Rope Lanyard and that it is in the proper orientation as shown in Figure 61.

**Web Model**

**Figure 58 - Insert Web Lanyard through Fixed Dual Slot D-Ring**

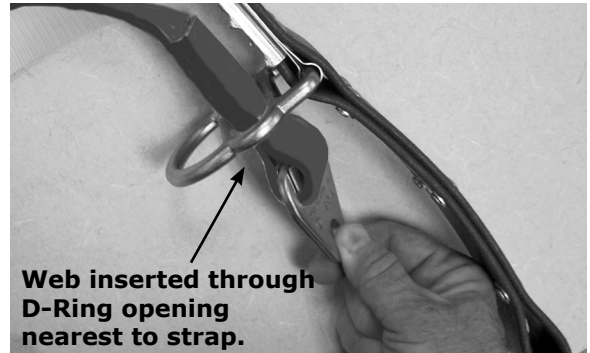

**Figure 60 - Connect Body Support Carabiner to Web End**



**Figure 62 - Right to Left Conversion Completed. Properly Attached to a Distribution Strap or Transmission Strap for Left Hand Use**



**NOTE:** Before use, make sure there are no twists in the Web Lanyard and that it is in the proper orientation as shown in Figure 62.

## 9.0 MAINTENANCE, STORAGE, AND TRANSPORT

**9.1 MAINTENANCE:** Clean the Cynch-Lok WPRD with water and a mild soap solution. Wipe off hardware with a clean, dry cloth, and hang to air dry. Do not force dry with heat. An excessive buildup of dirt, paint, etc. may prevent components of the Cynch-Lok Restraining Device from working properly, and in severe cases degrade components to a point where they have weakened and should be removed from service. If you have any questions concerning the condition of any component of the Cynch-Lok WPRD, or have any doubt about putting them into service, contact Capital Safety.

**9.2 STORAGE:** When not in use, store the Cynch-Lok WPRD in a cool, dry, clean environment; out of direct sunlight. Avoid areas where chemical vapors exist. After extended storage, thoroughly inspect all components per the guidelines in Section 5.2.

**9.3 TRANSPORT:** Transport the Cynch-Lok WPRD in the provided Carrying Bag.

## 10.0 SPECIFICATIONS

**10.1 STANDARDS:** When installed and used per the requirements and recommendations in this manual, the Cynch-Lok WPRD meets standards and requirements defined in Section 1.2.

## 11.0 LABELS

The following labels must be visible and legible on the equipment:

	<b>⚠ WARNING/ATTENTION</b> MANUFACTURER'S INSTRUCTIONS MUST BE READ AND UNDERSTOOD PRIOR TO USE. INSPECT BEFORE EACH USE. LES INSTRUCTIONS DU FABRIQUANT DOIVENT ETRE LUES ET COMPRISES PREALABLEMENT A L'UTILISATION. INSPECTER AVANT CHAQUE UTILISATION.		
	www.capitalsafety.com Capital Safety Red Wing, MN, USA +1-800-328-6146	MODEL NO. N° DE MODELE:	MFRD(YR/MO) FABR. (aa,mm):

<b>A: POLE STRAP INFORMATION</b> INFORMATION DE COURROIE DE POTEAU MODEL NO: MODELE: MFRD(YR/MO): FABR. (aa,mm) LOT NO:		<b>REPLACEMENT INFORMATION</b> A: POLE STRAP MODEL NO: 1200110 (DISTRIBUTION) 1200111 (TRANSMISSION) B: ADJUSTABLE LANYARD MODEL NO: 1200115 (ROPE) 1200136 (WEB)
		<b>INFORMATION DE REMPLACEMENT</b> A: N° DE MODELE COURROIE DE POTEAU: 1200110 (DISTRIBUTION) 1200111 (TRANSMISSION) B: N° DE MODELE LONGE AJUSTABLE: 1200115 (CORDE) 1200136 (WEB)

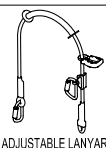
<b>INSPECTION LOG</b> RELEVÉ D'INSPECTION DATE INITIAL <table border="1"> <tr><td> </td><td> </td><td> </td><td> </td><td> </td><td> </td><td> </td><td> </td><td> </td><td> </td></tr> <tr><td> </td><td> </td><td> </td><td> </td><td> </td><td> </td><td> </td><td> </td><td> </td><td> </td></tr> </table> DO NOT REMOVE THIS LABEL NE PAS ENLEVER CETTE ÉTIQUETTE																						<b>A: POLE STRAP</b> COURROIE DE POTEAU 	<b>B: ADJUSTABLE LANYARD</b> LONGE AJUSTABLE

<b>⚠ ATTENTION</b> Les instructions du fabricant qui sont incluses avec le produit au moment de l'expédition doivent être suivies. Manquement à ces instructions pourrait causer des blessures graves ou même la mort. L'item a besoin d'être inspecté avant chaque usage. L'item ne doit pas entrer en contact avec des objets pointus ou abrasifs. Ne pas utiliser si l'item semble usé ou endommagé. Ce produit n'est pas à l'épreuve de la chaleur ou des flammes. Les connexions pour les anneaux en D doivent être compatibles en grosseur, force et forme. Utiliser seulement les modèles compatibles avec les produits de DBI SALA. La bonne utilisation de ce produit arrête une chute d'un poteau de bois seulement.		<b>SALA Cynch-Lok</b> POLE SIZE: 17.5" - 39" CIRCUMFERENCE (DISTRIBUTION) 17.5" - 39" CIRCUMFERENCE (TRANSMISSION) OSHA 1926.502(e) COMPLIANT ASTM F887-11 <b>TYPE: AB</b> Z259.14-12
	www.capitalsafety.com Capital Safety Red Wing, MN, USA +1-800-328-6146	MODEL NO. / MODELE: <input type="checkbox"/> 1204057 <input type="checkbox"/> 1204075 (DISTRIBUTION) <input type="checkbox"/> 1204058 <input type="checkbox"/> 1204076 (TRANSMISSION)

<b>⚠ WARNING</b> MANUFACTURER'S INSTRUCTION SUPPLIED WITH THIS PRODUCT AT TIME OF SHIPMENT MUST BE FOLLOWED. FAILURE TO DO SO COULD RESULT IN SERIOUS INJURY OR DEATH. INSPECT BEFORE EACH USE. AVOID CONTACT WITH SHARP AND ABRASIVE EDGES. DO NOT USE IF WEAR OR DAMAGE IS PRESENT. THIS PRODUCT IS NOT FLAME OR HEAT RESISTANT. CONNECTING D-RINGS MUST BE COMPATIBLE IN SIZE, SHAPE, AND STRENGTH. USE ONLY COMPATIBLE DBI SALA COMPONENTS WITH THIS PRODUCT. PROPER USE OF THIS PRODUCT WILL ARREST A FALL FROM A WOOD POLE ONLY.		<b>SALA Cynch-Lok</b> GRANDEUR POTEAU : 44.5 cm - 147 cm CIRCUMFERENCE (DISTRIBUTION) 44.5 cm - 147 cm CIRCUMFERENCE (TRANSMISSION) OSHA 1926.502(e) COMPATIBLE ASTM F887-11 <b>TYPE: AB</b> Z259.14-12
	www.capitalsafety.com Capital Safety Red Wing, MN, USA +1-800-328-6146	

**12.0 INSPECTION AND MAINTENANCE LOG**

<b>SERIAL NUMBER:</b>			
<b>MODEL NUMBER:</b>			
<b>DATE PURCHASED:</b>		<b>DATE OF FIRST USE:</b>	

<b>INSPECTION DATE</b>	<b>INSPECTION ITEMS NOTED</b>	<b>CORRECTIVE ACTION</b>	<b>MAINTENANCE PERFORMED</b>
Approved By:			
Approved By:			
Approved By:			
Approved By:			
Approved By:			
Approved By:			
Approved By:			
Approved By:			
Approved By:			
Approved By:			
Approved By:			
Approved By:			
Approved By:			
Approved By:			
Approved By:			
Approved By:			
Approved By:			
Approved By:			
Approved By:			
Approved By:			
Approved By:			
Approved By:			
Approved By:			
Approved By:			

## LIMITED LIFETIME WARRANTY

**Warranty to End User:** D B Industries, Inc., dba CAPITAL SAFETY USA ("CAPITAL SAFETY") warrants to the original end user ("End User") that its products are free from defects in materials and workmanship under normal use and service. This warranty extends for the lifetime of the product from the date the product is purchased by the End User, in new and unused condition, from a CAPITAL SAFETY authorized distributor. CAPITAL SAFETY'S entire liability to End User and End User's exclusive remedy under this warranty is limited to the repair or replacement in kind of any defective product within its lifetime (as CAPITAL SAFETY in its sole discretion determines and deems appropriate). No oral or written information or advice given by CAPITAL SAFETY, its distributors, directors, officers, agents or employees shall create any different or additional warranties or in any way increase the scope of this warranty. CAPITAL SAFETY will not accept liability for defects that are the result of product abuse, misuse, alteration or modification, or for defects that are due to a failure to install, maintain, or use the product in accordance with the manufacturer's instructions.

CAPITAL SAFETY'S WARRANTY APPLIES ONLY TO THE END USER. THIS WARRANTY IS THE ONLY WARRANTY APPLICABLE TO OUR PRODUCTS AND IS IN LIEU OF ALL OTHER WARRANTIES AND LIABILITIES, EXPRESSED OR IMPLIED. CAPITAL SAFETY EXPRESSLY EXCLUDES AND DISCLAIMS ANY IMPLIED WARRANTIES OF MERCHANTABILITY OR FITNESS FOR A PARTICULAR PURPOSE, AND SHALL NOT BE LIABLE FOR INCIDENTAL, PUNITIVE OR CONSEQUENTIAL DAMAGES OF ANY NATURE, INCLUDING WITHOUT LIMITATION, LOST PROFITS, REVENUES, OR PRODUCTIVITY, OR FOR BODILY INJURY OR DEATH OR LOSS OR DAMAGE TO PROPERTY, UNDER ANY THEORY OF LIABILITY, INCLUDING WITHOUT LIMITATION, CONTRACT, WARRANTY, STRICT LIABILITY, TORT (INCLUDING NEGLIGENCE) OR OTHER LEGAL OR EQUITABLE THEORY.



The Ultimate in Fall Protection

### **CSG USA & Latin America**

3833 SALA Way  
Red Wing, MN 55066-5005  
Toll Free: 800.328.6146  
Phone: 651.388.8282  
Fax: 651.388.5065  
solutions@capitalsafety.com

### **CSG Canada**

260 Export Boulevard  
Mississauga, ON L5S 1Y9  
Phone: 905.795.9333  
Toll-Free: 800.387.7484  
Fax: 888.387.7484  
info.ca@capitalsafety.com

### **CSG Northern Europe**

5a Merse Road  
North Moons, Moat  
Reditch, Worcestershire, UK  
B98 9HL  
Phone: + 44 (0)1527 548 000  
Fax: + 44 (0)1527 591 000  
csgne@capitalsafety.com

### **CSG EMEA (Europe, Middle East, Africa)**

Le Broc Center  
Z.I. 1ère Avenue  
5600 M B.P. 15 06511  
Carros  
Le Broc Cedex  
France  
Phone: + 33 4 97 10 00 10  
Fax: + 33 4 93 08 79 70  
information@capitalsafety.com

### **CSG Australia & New Zealand**

95 Derby Street  
Silverwater  
Sydney NSW 2128  
AUSTRALIA  
Phone: +(61) 2 8753 7600  
Toll-Free : 1 800 245 002 (AUS)  
Toll-Free : 0800 212 505 (NZ)  
Fax: +(61) 2 87853 7603  
sales@capitalsafety.com.au

### **CSG Asia**

*Singapore:*  
16S, Enterprise Road  
Singapore 627666  
Phone: +65 - 65587758  
Fax: +65 - 65587058  
inquiry@capitalsafety.com

### *Shanghai:*

Rm 1406, China Venturetech Plaza  
819 Nan Jing Xi Rd,  
Shanghai 200041, P R China  
Phone: +86 21 62539050  
Fax: +86 21 62539060

[www.capitalsafety.com](http://www.capitalsafety.com)

