



The Ultimate in Fall Protection

# USER INSTRUCTIONS 1

# LAD-SAF™ 2 Flexible Cable Ladder Safety Systems

<b>3</b>	
	ANSI A14.3
	CSA Z259.2.5

<b>X1</b> <b>4</b>	<b>40-141 KG / 88-310 LBS</b> <b>5</b>
<b>6</b>	<b>7</b>

## 1

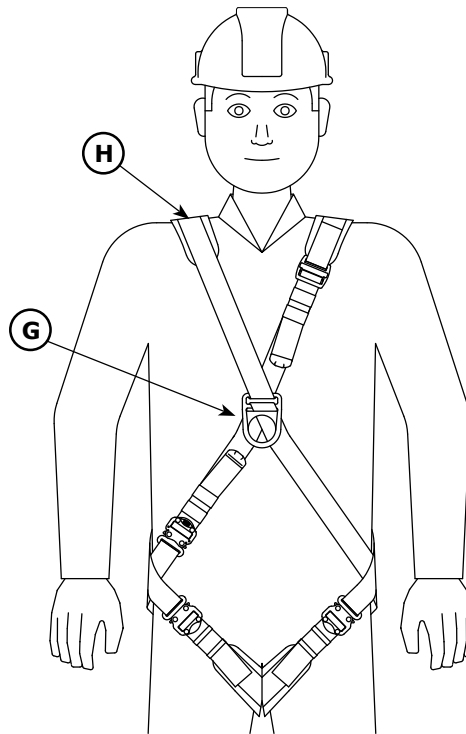
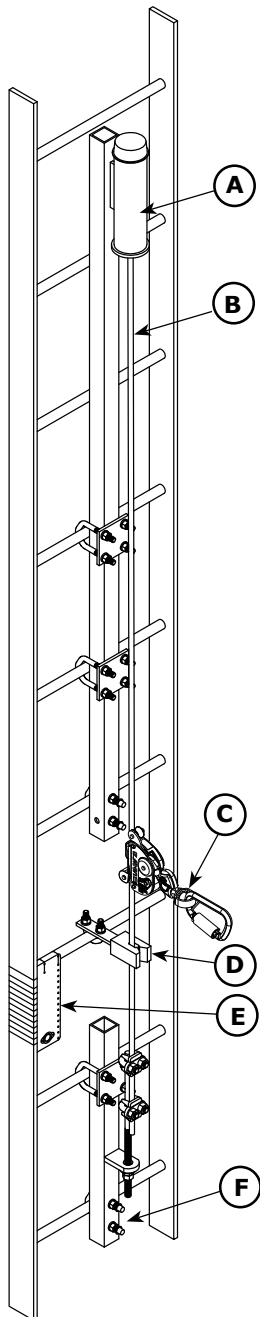

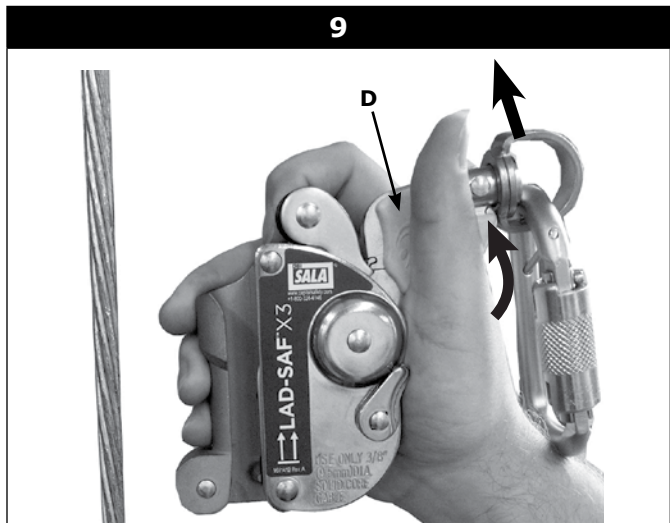
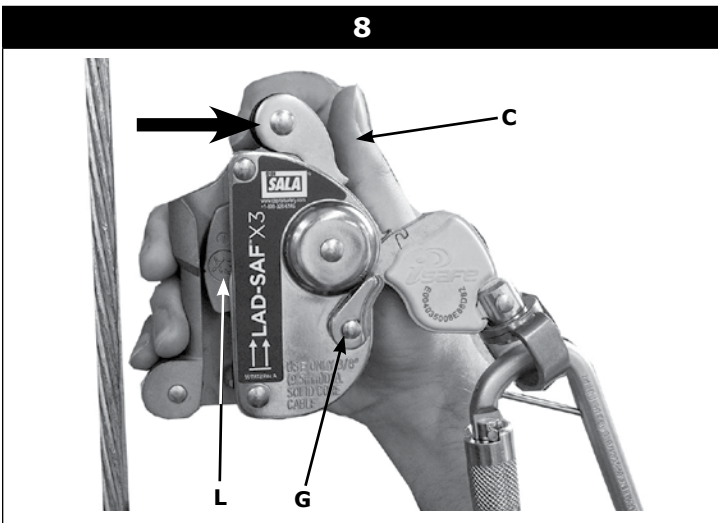
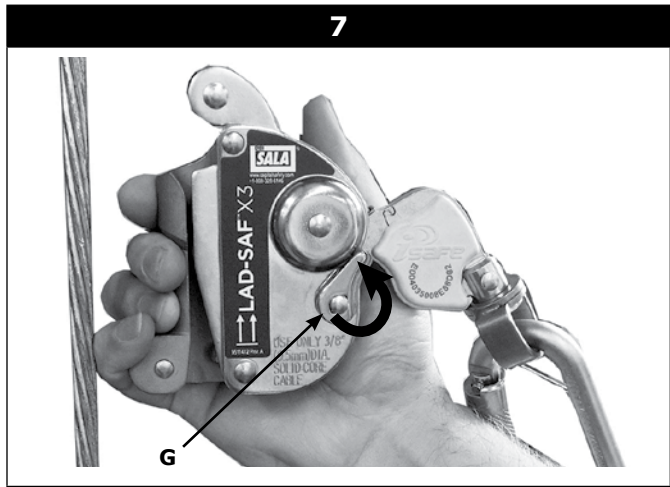
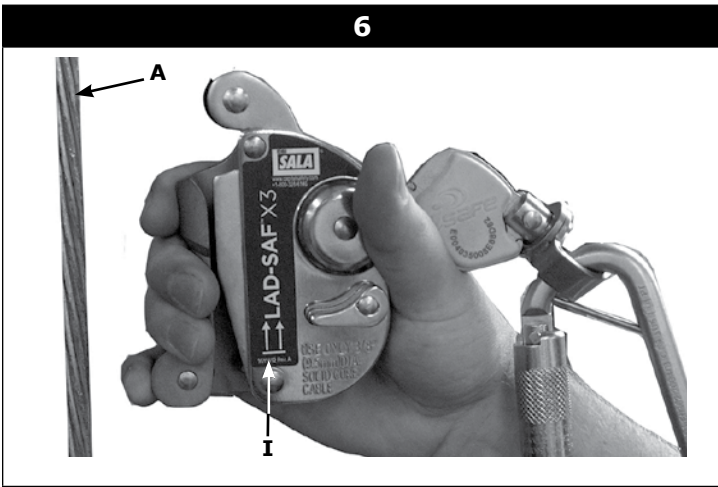
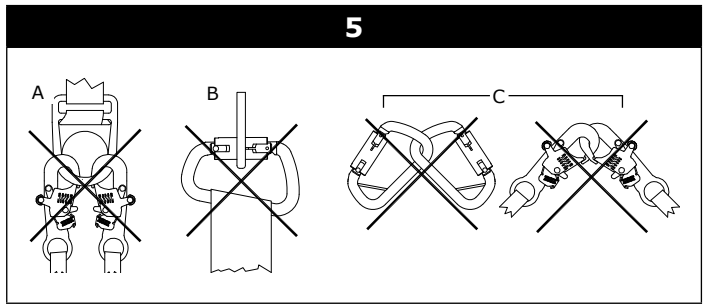
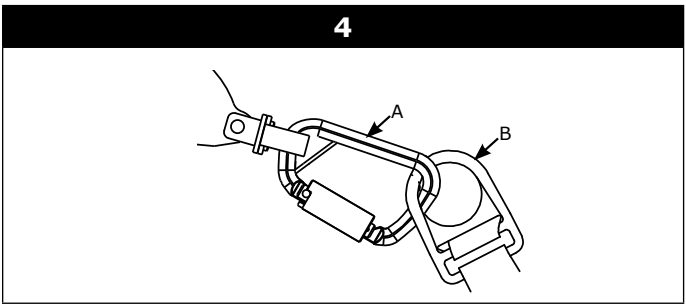
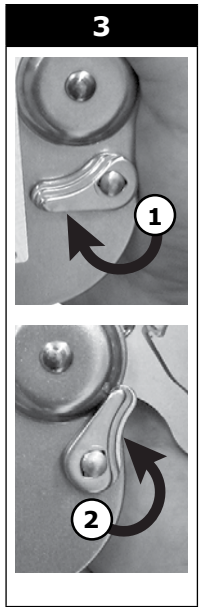
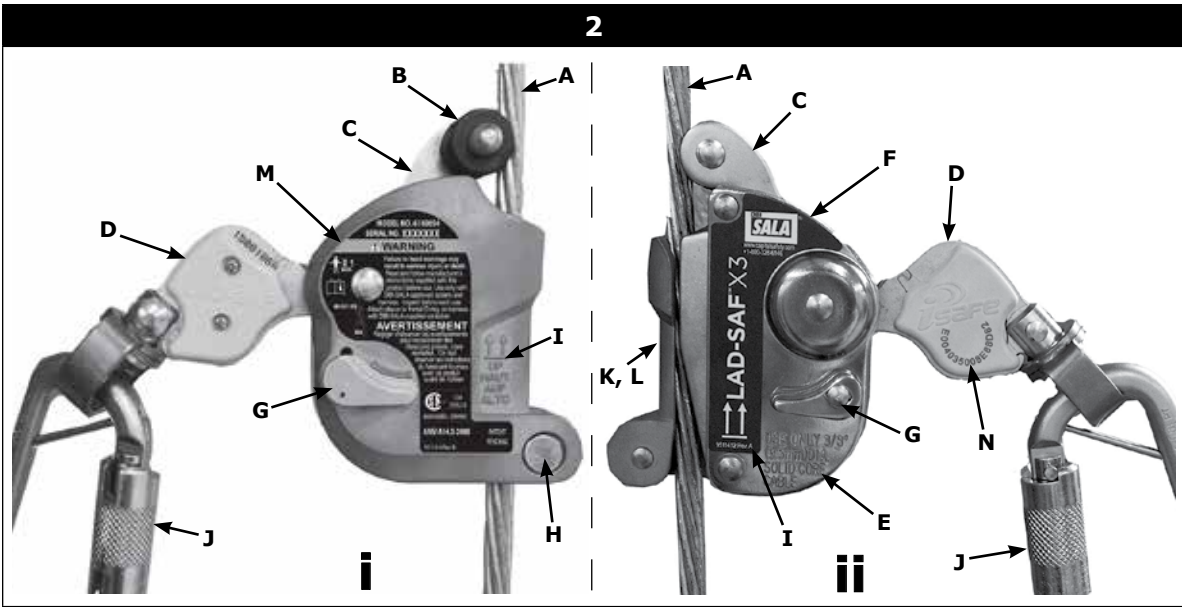

10

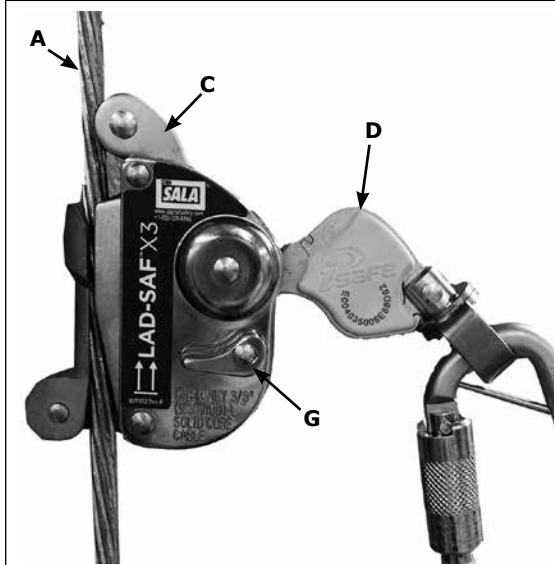

11

ANSI A14.3-2008  
CSA Z259.25  
automatic, sternal  
5,26x5,98

DBI  
**SALA**  
www.dbi-sala.com  
(800) 328-6146

CE 0086  
EN 352-1:2014

1	2	3
ANSI A14.3-2008	CSA Z259.25	EN 352-1:2014
6116540	6116541	6116542
6116543	6116544	6116545
6116546	6116547	6116548
6116549	6116550	6116551
6116552	6116553	6116554
6116555	6116556	6116557
6116558	6116559	6116560
6116561	6116562	6116563
6116564	6116565	6116566
6116567	6116568	6116569
6116570	6116571	6116572
6116573	6116574	6116575
6116576	6116577	6116578
6116579	6116580	6116581
6116582	6116583	6116584
6116585	6116586	6116587
6116588	6116589	6116590
6116591	6116592	6116593
6116594	6116595	6116596
6116597	6116598	6116599
6116600	6116601	6116602
6116603	6116604	6116605
6116606	6116607	6116608
6116609	6116610	6116611
6116612	6116613	6116614
6116615	6116616	6116617
6116618	6116619	6116620
6116621	6116622	6116623
6116624	6116625	6116626
6116627	6116628	6116629
6116630	6116631	6116632
6116633	6116634	6116635
6116636	6116637	6116638
6116639	6116640	6116641
6116642	6116643	6116644
6116645	6116646	6116647
6116648	6116649	6116650
6116651	6116652	6116653
6116654	6116655	6116656
6116657	6116658	6116659
6116660	6116661	6116662
6116663	6116664	6116665
6116666	6116667	6116668
6116669	6116670	6116671
6116672	6116673	6116674
6116675	6116676	6116677
6116678	6116679	6116680
6116681	6116682	6116683
6116684	6116685	6116686
6116687	6116688	6116689
6116690	6116691	6116692
6116693	6116694	6116695
6116696	6116697	6116698
6116699	6116700	6116701
6116702	6116703	6116704
6116705	6116706	6116707
6116708	6116709	6116710
6116711	6116712	6116713
6116714	6116715	6116716
6116717	6116718	6116719
6116720	6116721	6116722
6116723	6116724	6116725
6116726	6116727	6116728
6116729	6116730	6116731
6116732	6116733	6116734
6116735	6116736	6116737
6116738	6116739	6116740
6116741	6116742	6116743
6116744	6116745	6116746
6116747	6116748	6116749
6116750	6116751	6116752
6116753	6116754	6116755
6116756	6116757	6116758
6116759	6116760	6116761
6116762	6116763	6116764
6116765	6116766	6116767
6116768	6116769	6116770
6116771	6116772	6116773
6116774	6116775	6116776
6116777	6116778	6116779
6116780	6116781	6116782
6116783	6116784	6116785
6116786	6116787	6116788
6116789	6116790	6116791
6116792	6116793	6116794
6116795	6116796	6116797
6116798	6116799	6116800

**WARNING**  
Failure to heed warnings may result in death.  
This product is not to be used for any purpose other than that intended.  
Use only with DBI-SALA approved system as part of a fall protection system.  
This product is not to be used for any other purpose.  
Do not use system with components not approved by DBI-SALA.  
Inspect system in accordance with training and manufacturer's instructions.  
Minimum spacing of users of this system is 20'.

**WARNING**  
Failure to heed warnings may result in death.  
This product is not to be used for any purpose other than that intended.  
Use only with DBI-SALA approved system as part of a fall protection system.  
This product is not to be used for any other purpose.  
Do not use system with components not approved by DBI-SALA.  
Inspect system in accordance with training and manufacturer's instructions.  
Minimum spacing of users of this system is 20'.

SYSTEM CAPACITY  
1 MAX  
2  
3  
4

INSPECTION  
DATE  
BY

PROOF TEST (OPTIONAL)

SYSTEM INSTALLATION  
DATE

856421 Rev. E

12

MODEL NO. 6160054  
SERIAL NO. XXXXXXXX

**WARNING**

Failure to heed warnings may result in serious injury or death.  
Read and follow manufacturer's instructions supplied with this product before use. Use only with DBI-SALA approved system as part of a fall protection system. Inspect before each use. Attach sleeve to frontal D-ring on harness with DBI-SALA supplied carabiner.

40-141 KG  
MAX

**AVERTISSEMENT**

Négliger d'observer les avertissements peut occasionner des blessures graves, voire mortelles. On doit observer les instructions du fabricant fournies avec ce produit avant de l'utiliser.

CSA Z259.25  
automatic, sternal

ANSI A14.3-2008 PATENT PENDING  
9511414 Rev. B

13



14

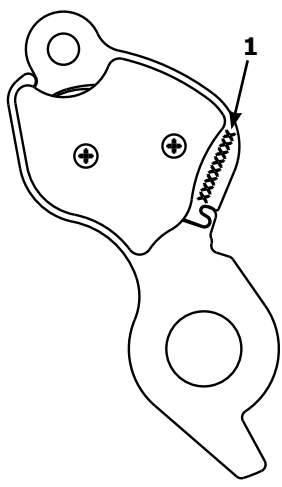

15

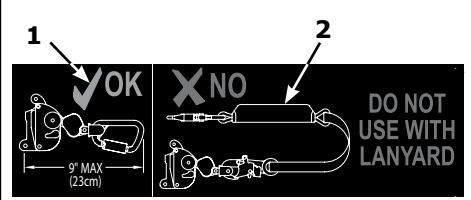

16

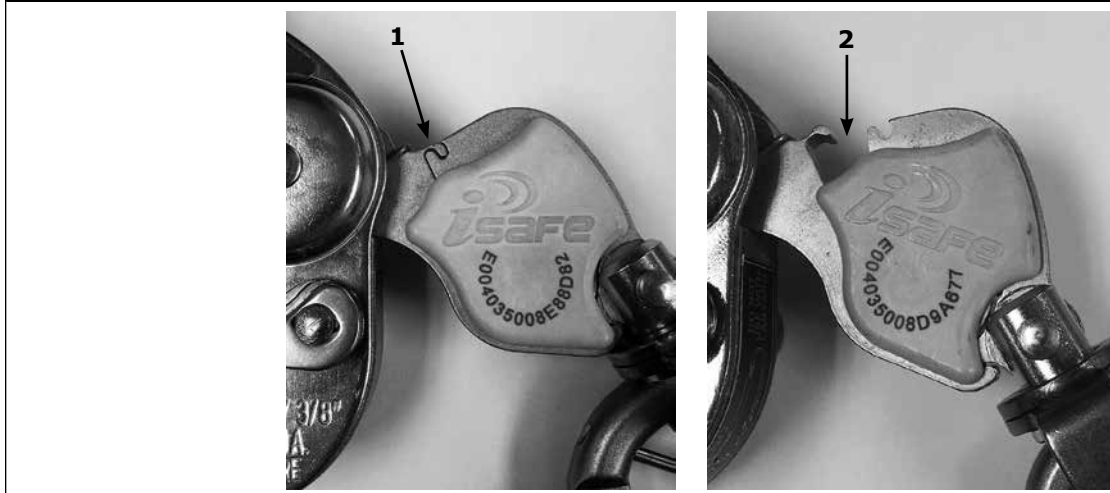

## FORWARD

This instruction manual describes the use and maintenance of the Lad-Saf™ Flexible Cable Ladder Safety System and Lad-Saf™ X3 Detachable Cable Sleeve. It should be used as part of an employee training program as required by OSHA, ANSI and CSA and must be kept with the equipment.



- **To avoid serious injury or death follow the safety information in these instructions.**
- **Users must be trained and competent in safe use procedures before use of this equipment.**
- **Users must read and understand these instructions before use of this equipment.**
- **Installers must read and follow the manufacturer's instructions for safety equipment used with this system.**
- **Follow these instructions for proper use, inspection, and maintenance of this equipment before installing this equipment.**
- **Sleeve and system must be inspected after a fall. If the energy absorber/fall indicator on the sleeve is deployed (Figure 19, example 2), the sleeve must be removed from service. If there are any nicks or kinks in the ladder cable, the cable must be inspected by a competent person prior to use.**
- **Repairs must be conducted by authorized service providers ONLY.**
- **This equipment is intended to be used as part of a complete Lad-Saf™ Ladder Safety System. Alterations, substitutions, and misuse of this equipment, or failure to follow instructions, may result in serious injury or death.**



**If you have questions on the use, maintenance, or suitability of this equipment for your application, contact DBI-SALA.**



**Before using this equipment, find the product identification information on the installation and service label and record it in the Inspection & Maintenance Log in Section 8 of this manual.**



- **The full body harness must be properly adjusted to a snug fit and should not be used if loose.**
- **If the full body harness becomes loose during ascent or descent it should be properly adjusted again from a secured position.**

## GLOSSARY REFERENCES

Numbered Glossary References on the front cover of this instruction reference the following items:

①	User Instructions.	⑤	Minimum user weight, excluding tools and equipment, is 40 kg (88 lbs) and maximum user weight, including tools and equipment, is 141 kg (310 lbs).
②	Lad-Saf™ Flexible Cable Ladder Safety Systems	⑥	Read User Instructions.
③	Standards.	⑦	Warning symbol.
④	Detachable Cable Sleeve is for the use of one person only.		

## 1.0 APPLICATIONS

- 1.1 PURPOSE:** Lad-Saf™ Flexible Cable Ladder Safety Systems (Figure 1) are designed to protect a worker in the event of a fall while climbing fixed ladders or similar climbing structures. The Lad-Saf™ X3 Detachable Cable Sleeve (Figures 1 and 2) attaches to a Lad-Saf™ Flexible Cable Ladder Safety System. The sleeve is designed to arrest the fall of a worker in the event of a fall while climbing a fixed ladder. The Lad-Saf™ X3 Detachable Cable Sleeve is not intended to be used for material handling. **Use only for intended purpose.**

**Lad-Saf™ X3 Detachable Cable Sleeve models covered by this instruction:**

Model	Part Number	Standard	Description
LS-1	6160054	ANSI (A14.3), CSA (Z259.2.5)	Lad-Saf™ X3 Detachable Cable Sleeve with ZP Carabiner

**Lad-Saf Systems that use the Lad-Saf™ X3 Detachable Cable Sleeve:**

System Instruction Number	System Type	System Description
5902228	Vertical	Lad-Saf™ Flexible Cable Ladder Safety System
5903435	Vertical	Lad-Saf™ Flexible Cable Ladder Safety System with swivel D-Ring

**Lad-Saf™ Flexible Cable Ladder Safety System Components, Figure 1**

<b>A</b>	Top Bracket	<b>D</b>	Cable Guide	<b>G</b>	Frontal D-Ring
<b>B</b>	Cable	<b>E</b>	i-Safe RFID Tag	<b>H</b>	Full Body Harness
<b>C</b>	Cable Sleeve	<b>F</b>	Bottom Bracket		

**Lad-Saf™ X3 Detachable Cable Sleeve Components, Figure 2** (“i” is Back of Sleeve, “ii” is front of Sleeve)

<b>A</b>	Cable (not component)	<b>D</b>	Handle/Energy Absorber/ Fall Indicator	<b>G</b>	Locking Lever	<b>J</b>	Carabiner	<b>M</b>	ID Label
<b>B</b>	Upper Roller	<b>E</b>	Sleeve Body	<b>H</b>	Lower Roller	<b>K</b>	Gravity Stop	<b>N</b>	iSafe Tag
<b>C</b>	Rotating Side Plate	<b>F</b>	Logo Label	<b>I</b>	This way UP Arrow	<b>L</b>	Cam		

**Cable types approved for use with the Lad-Saf™ X3 Detachable Cable Sleeve**

<b>ANSI, CSA Cable Part Number</b>	<b>DESCRIPTION</b>
9500098	Cable, 3/8, 7 x 19, Galvanized
9500099	Cable, 3/8, 7 x 19, 304 Stainless Steel
9500396	Cable, 3/8, 1 x 7, Galvanized
9500397	Cable, 3/8, 1x 7, 304 Stainless Steel

- 1.2 LIMITATIONS:** The Lad-Saf™X3 Detachable Cable Sleeve must be used with a DBI-SALA approved ladder safety system. Use only a 3/8 inch (9.5 mm) diameter solid core cable with the Detachable Cable Sleeve. The ladder safety system must have a maximum angle of 15° from vertical.

The minimum temperature that the Detachable Cable Sleeve, including a rigid anchor line, is approved for is -22°F (-30°C).

 **The Lad-Saf™ X3 Detachable Cable Sleeve must be directly connected to an approved full body harness with the attached carabiner or snap hook (Figure 2, J or N). Do not use connection devices other than the carabiner or snap hook that is part of the Lad-Saf™ X3 Detachable Cable Sleeve.**

**NOTE: ANSI A14.3 and OSHA 1926.1053 state that the length of connection between the carrier and attachment point must not exceed 9 inches (23 cm).**

## 2.0 SYSTEM REQUIREMENTS

- 2.1 COMPATIBILITY OF COMPONENTS AND SUBSYSTEMS:** This equipment is designed for use with DBI-SALA approved components and subsystems. The use of non-approved components and subsystems (i.e. harnesses, lanyards, etc.) may jeopardize compatibility of equipment, and could affect the safety and reliability of the complete system. If you have questions on the installation or suitability of this equipment for your application, contact DBI-SALA.

- 2.2 COMPATIBILITY OF CONNECTORS:** (See Figure 4)

 **Use only supplied connectors.**

Connect carabiner (A) to frontal D-Ring (B).

- 2.3 MAKING CONNECTIONS:** (See Figure 5)  
Capital Safety snap hooks and carabiners **should not** be connected:

- A. To a D-Ring to which another connector is attached.
- B. In a manner that would result in a load on the gate.
- C. To each other.

 **Ensure all connectors are fully closed and locked.**

## 3.0 OPERATION AND USE

- 3.1 LAD-SAF™ SYSTEM USE: BEFORE EACH USE** inspect the system and cable sleeve according to section 5.0. Verify from the label markings that the system has been formally inspected within the last year. **DO NOT USE** an improperly maintained Lad-Saf™ system and **DO NOT CLIMB** a structure that is not in good condition. Inspect the detachable cable sleeve according to Section 5.3. Inspect the full body harness according to manufacturer’s instructions. Inspect the Lad-Saf Ladder Safety System according to Section 5.4.

- 3.2 PLAN** your use of the Lad-Saf™ system **before starting work**. Consider all factors that will affect your safety **before starting your work**.

 **To avoid serious injury or death, follow the safety information in this section:**

- Ensure the system is rated for the required number of users.
- There are hazards associated with connecting and disconnecting from the system. Use secondary fall arrest protection. Ensure adequate anchor points, landing platforms, or other means are available at connection and disconnection points to allow safe transitions to and from the system.
- Identify hazards in the work area that could cause injury to the user or damage to the system, such as: high heat, electrical hazards, chemical hazards, falling objects, or moving machinery.

- A minimum fall clearance of 7 ft. (2 m) is required between the user's feet and surface below. The user may not be protected against hitting the ground or landing during the first 7 ft. (2 m) of ascent or last 7 ft. (2 m) of descent. Use proper climbing procedures (e.g., maintain 3 points of contact with hands and feet) when ascending or descending any portion of the ladder unprotected by the Lad-Saf™ system.
- Use proper safety procedures when climbing. Do not carry tools or equipment by hand. Keep your hands free for climbing. Secure carried items to avoid dropping them on climbers below. Climb within your ability. Long climbs may require several rest stops during ascent or descent to avoid exhaustion. Use proper work positioning equipment for rest breaks. DO NOT climb in high winds or severe weather.
- Ensure only one user is climbing between cable guides.

**3.3 CONNECT THE DETACHABLE CABLE SLEEVE TO THE CARRIER CABLE:** See Figure 2 for identification of components referenced in the following steps:

- Step 1.** (See Figure 6) Position the sleeve so that the the "up" arrow on the sleeve (I) is pointing to the ascending direction.
- Step 2.** (See Figure 7) Rotate the locking lever (G) to the unlocked position. Figure 3 shows locked (1) and unlocked (2) locking lever positions. The locking lever is on both sides of the detachable cable sleeve for both right and left hand operation.
- Step 3.** (See Figure 8) Pull back on the rotating side plate (C) to its furthest position. Once the rotating side plate is in its furthest rotated position, the locking lever (G) may be released. The cam (L) will be fully extended.
- Step 4.** (See Figure 9) Rotate the handle (D) to its full upright position. This will allow the cam (L) to drop out of the way in order to install the sleeve on the cable.
- Step 5.** (See Figure 10) Hold the sleeve upright and insert the cable (A) through the slot on the side of the sleeve with a lifting motion upwards. Position the cable in the sleeve recess. Release the handle (D), rotating side plate (C) and locking lever (G) to lock the sleeve on the cable. **Ensure the locking lever (G) is in the locked position before use.**

**3.4 CONNECT THE LAD-SAF™ X3 DETACHABLE CABLE SLEEVE TO THE HARNESS:**

	<ul style="list-style-type: none"> <li>• <b>Connect the carabiner on the sleeve (Figure 2, J) to the full body harness frontal D-Ring (Figure 1, G) designated for ladder climbing. The D-Ring is located above the user's center of gravity and centrally located near the sternum.</b></li> <li>• <b>Always use the carabiner or snap hook connector supplied with the sleeve. Do not substitute with other connectors.</b></li> <li>• <b>Do not use other connecting devices or combine devices such as a lanyard, chain, link, clevis, etc. with the connector supplied with the sleeve.</b></li> <li>• <b>Connection between the sleeve and full body harness may be done before or after the sleeve has been installed onto the carrier cable.</b></li> <li>• <b>When connecting, ensure the carabiner is fully closed and locked.</b></li> </ul>
---	---

	<b>Use secondary fall protection (e.g. lanyard) while connecting or disconnecting the sleeve to or from the carrier cable. Make certain to complete connection of the sleeve to the cable before removing the secondary fall protection.</b>
---	--

	<b>DO NOT USE the Lad-Saf™ X3 Detachable Cable Sleeve as work positioning equipment. Use proper work positioning equipment where necessary.</b>
---	---

	<b>Handling the sleeve during ascent or descent exposes the worker to fall hazards.</b>
---	---

**ASCENDING:** To ascend the ladder climb up while maintaining three points of contact at all times (with hands and feet). The Lad-Saf™ X3 Detachable Cable Sleeve will follow the climber. The carrier cable is snapped out of the cable guides (Figure 1, D) as they are encountered. **Do not handle or remove the sleeve from the carrier cable when passing the cable guides or if the sleeve locks.**

**DESCENDING:** To descend the ladder, climb down smoothly while maintaining three points of contact at all times (with hands and feet). Allow the Lad-Saf™ X3 Detachable Cable Sleeve to "lead" the climber down. Climbing down out of position (e.g., leaning back excessively or climbing erratically) may cause the sleeve to lock onto the carrier cable. If the sleeve locks, climb upward slightly to allow the sleeve to unlock and then continue to descend the ladder. Reconnect the carrier cable into the cable guides after passing each cable guide. **Do not handle or remove the sleeve from the carrier cable when passing the cable guides or if the sleeve locks.**

When climbing is completed (see Figure 2):

- Step 1.** Remove the sleeve from the cable by rotating the locking lever (G).
- Step 2.** Pull back on the side plate (C) and pivot the handle (D) to its full upright position.
- Step 3.** The sleeve can now be removed from cable and properly stored.

	<ul style="list-style-type: none"> <li>• <b>Identify hazards to avoid climber injury.</b></li> <li>• <b>Hazardous environments or conditions include, but are not limited to; power lines, heat or flame, explosive gases, physical obstructions, and climbers ability and health.</b></li> </ul>
---	---

	<b>IN THE EVENT OF A FALL, The Lad-Saf™ X3 Detachable Cable Sleeve must be removed from service.</b>
---	--

	<b>The user (employer) must have a rescue plan in place and the ability to implement the plan in the event of a fall.</b>
---	---

## 4.0 TRAINING

- 4.1 TRAINING:** Users and purchasers of this equipment must be trained in the correct care and use of this equipment as detailed in this manual. It is the responsibility of the user and purchaser of this equipment to assure they are familiar with these instructions, operating characteristics, application limits, and the consequences of improper use of this equipment.



**Training must be conducted without exposing the user to a fall hazard. Training should be repeated on a periodic basis.**

- Step 1.** Attach sleeve to approved carrier cable. Use a full body harness with frontal D-Ring and attach to Lad-Saf™ X3 Detachable Cable Sleeve.
- Step 2.** Ascend the ladder to approximately three feet. With both hands and feet on the climbing structure flex knees in a quick sitting motion to simulate a fall and activate the sleeve.
- Step 3.** After the sleeve locks, move upward to unlock the sleeve. Repeat Steps 2 and 3 several times to become familiar with sleeve operation.
- Step 4.** Descend the ladder to the ground and detach the sleeve connection. Remove the sleeve from the cable.

## 5.0 INSPECTION

### 5.1 FREQUENCY:

See Figure 2 for identification of the components described in the following guidelines:

- **Before Each Use:** Visually inspect the full body harness, Lad-Saf™ X3 Detachable Cable Sleeve, Lad-Saf™ Ladder System installation, and ladder structure. Use the guidelines provided in section 5.3 or 5.4 to check the system to the extent possible before attaching. Check the system label (section 8) to verify that annual inspection is current. **If the condition of the system is in doubt, do not use.**
- **Periodic Formal Inspection:** A formal inspection of the Lad-Saf™ X3 Detachable Cable Sleeve, Lad-Saf™ Ladder System installation, and the ladder structure must be performed at least annually by a competent person other than the user. See Sections 5.3 and 5.4 for inspection specifics. Record the results at the end of this manual.
- **After a Fall:** If a fall occurs with the Lad-Saf™ Ladder System a formal inspection of the entire system must be performed by a competent person other than the user. **A separate fall protection system must be used while inspecting the Lad-Saf system.** See sections 5.3, 5.4 and 5.5. Record the inspection results in the *Inspection and Maintenance Logs* at the end of this manual.

- 5.2 If inspection reveals an unsafe or defective condition** remove the Lad-Saf™ X3 Detachable Cable Sleeve or the Lad-Saf™ Ladder System from service. Contact an authorized service center for repair or destroy the sleeve. **DO NOT ATTEMPT UNAUTHORIZED REPAIR.** Record the results of this inspection in the *Inspection and Maintenance Log* in this manual.

- 5.3 INSPECTION GUIDELINES - LAD-SAF™ DETACHABLE CABLE SLEEVE:** See Figure 2 for identification of the components described in the following guidelines:

- Inspect the handle/energy absorber/fall indicator (item D) for bends, cracks, and deformities. All fasteners must be securely attached. Operation of handle and cam must be free and smooth. Springs must be secure and of sufficient strength to pull handle down.

The handle/energy absorber/fall indicator will be deformed if it has been used for fall arrest. Figure 16 shows an example of a handle/energy absorber/fall indicator that has not been used for fall arrest (1) and a handle/energy absorber that has been used for fall arrest and is deformed (2). **If the handle/energy absorber is deformed, DO NOT USE. The sleeve must be removed from service.**

- Inspect the locking lever (item G) for smooth operation, ensuring it springs back into its locked position when released.
- Inspect the cam (item L) for wear. Confirm that there is no damage to the cam.
- Inspect cam (item L) by holding the sleeve vertically with the handle/energy absorber (item D) in the upright position and shaking the sleeve up and down to simulate a fall. The cam should rotate freely.
- Inspect cam (item L) by positioning the sleeve horizontally with the handle/energy absorber (item D) in the upright position and placing the sleeve on the back side on a flat surface with the Lad-Saf X3 label facing up. The cam should rotate fully upwards to the top of the sleeve.
- Inspect the operation of the rotating side plate (item C) by pulling it back to try to open the cable slot. It must not rotate. If it does rotate without having to rotate the locking lever (Figure 2, item G), remove the sleeve from service.

- 5.4 INSPECTION GUIDELINES - LAD-SAF™ LADDER SAFETY SYSTEM:** Refer to the Installation Instructions supplied with your Lad-Saf Flexible Cable Ladder Safety System (Lad-Saf™ Flexible Cable Ladder Safety Systems Installation Instructions, Capital Safety manual #5902228 or #5903435.) when performing the inspection procedures described in this section.

**A separate fall protection system must be used during the System Inspection.**

**Top Brackets:**

- Inspect for proper installation per Capital Safety Lad-Saf™ Flexible Cable Ladder Safety Systems Installation Instructions, Capital Safety manual #5902228 or #5903435.
- Check for visible damage or corrosion. Look for cracks, bends or wear that could affect the strength and operation of the system. Inspect welds. Look for cracked or broken welds that could affect strength of bracket. Replace parts if defects are found.

- Check for loose or missing fasteners that secure top bracket to structure (bolts, clamp plates, U bolts). If fasteners are loose, re-tighten as necessary to the torque levels listed in the Installation Instructions supplied with your Lad-Saf Flexible Cable Ladder Safety System.
- Inspect carrier clamps (some models will contain a swaged on carrier lug in place of the carrier clamp). Cable should extend above carrier clamp 1.0 inch (2.5 cm) to 2.0 inch (5.0 cm). Adjust cable if amount of cable extension is outside of described range. Steel washer should be present between carrier clamp and shock absorber.
- Look down the inside of the pipe and inspect the shock absorber for damage such as cracks or splits. The bottom of the shock absorber should project out the bottom hole in the top bracket pipe. Replace the shock absorber if defects are found.
- Inspect the cap that fits on the top of the pipe. Check for cracks or damage to the cap. The cap should fit securely onto the pipe. Replace if defects are found.

☑ **Bottom Bracket:**

- Inspect for proper installation per Capital Safety Lad-Saf™ Flexible Cable Ladder Safety Systems Installation Instructions, Capital Safety manual #5902228 or #5903435.
- Check for damage or corrosion. Look for cracks, bends or wear that could affect the strength and operation of the system. Replace parts if defects are found.
- Check for loose or missing fasteners that secure bottom bracket to the structure. If fasteners are loose, re-tighten as necessary to the torque levels listed in the Installation Instructions supplied with your Lad-Saf Flexible Cable Ladder Safety System.
- Inspect the tension rod assembly. Make certain saddle clips securely retain the cable. Check torque on saddle clamps – 35 ft. lbs. (47 N-m). Replace or retighten if defects are found.

☑ **Cable Guides:**

- Check cable guides for damage. Look for wear or damage to black urethane. Cable guides should restrain the cable and prevent cable contact with the ladder/structure. Cable guides should be placed approximately every 25 ft (8 m) or closer if required. Replace parts if defects are found.
- Check cable guide fasteners. The fasteners should secure cable guide in position. Tighten as necessary.

☑ **Cable and Cable Tension:**

- Inspect the cable for corrosion, kinks or damage that will affect strength and impede the cable sleeve from traveling on the cable. If there are any nicks or kinks in the ladder cable, the cable must be inspected by a competent person prior to use. Inspect for signs of abrasion against the ladder or structure. Replace the cable if defects are found.
- Inspect the cable tension. For systems that utilize a compression spring, the spring in the bottom bracket should be compressed to 5-1/2 inch (13.8 cm) length. For systems that utilize a tension rod and tension indicator washer, the washer should be indicated (center ridge sheared off) and the washer imbedded fully into hole of bottom bracket. You should not be able to pull tension rod down by hand. Cable should be tight enough to prevent contact with the ladder/structure. Re-tension the cable if necessary. For bottom brackets that contain an indicating washer, a new washer (part no. 9504239) should be installed if the cable is re-tensioned. Tighten the system until indicating washer ring is sheared off. **Do not over-tension the system.**

☑ **Installation and Service Label:**

- Inspect the installation and service label. The label should be securely attached and fully legible. The installation date and number of users allowed on the system should be clearly marked on the label. Record the inspection date on the label after this inspection is completed.

☑ **Ladder/Climbing Structure:**

- Inspect the ladder/climbing structure to which the Lad-Saf™ system is attached. Make sure the structure is in good condition, secure, and safe to climb. **DO NOT USE if the condition of the structure is questionable.** Consult instructions and/or personnel familiar with the structure prior to use.

**5.5 I-SAFE™ RFID TAG:**

The Lad-Saf™ system and the Lad-Saf™ X3 Detachable Cable Sleeve include an i-Safe™ Radio Frequency Identification (RFID) tag (Figure 2, Item N & Figure 11, Item 4). The RFID tag can be used in conjunction with the i-Safe handheld reading device and web based portal to simplify inspection and inventory control and provide records for your fall protection equipment. If you are a first-time user, contact a Capital Safety Customer Service representative (see back cover). If you have already registered, go to [www.capitalsafety.com/isafe.html](http://www.capitalsafety.com/isafe.html). Follow the instructions provided with your i-Safe handheld reader or on the web portal to transfer your data to your web log.

**6.0 MAINTENANCE, SERVICING, STORAGE**

**6.1** See section 5.0 for inspection related maintenance issues. If the carrier cable becomes heavily soiled with oil, grease, paint, or other substances, clean it with warm soapy water. Wipe off the cable with a clean, dry cloth. Do not force dry with heat. Do not use acid or caustic chemicals that could damage the cable.

Additional maintenance and servicing procedures must be completed by an authorized service center. Authorization must be in writing.

The Lad-Saf™ X3 Detachable Cable Sleeve may be cleaned with warm, soapy water.

Store the Lad-Saf™ X3 Detachable Cable Sleeve in a cool, dry, clean environment, out of direct sunlight. Avoid areas where chemicals vapors exist. Thoroughly inspect the sleeve after extended storage.

Transport the Lad-Saf™ system in an enclosure to protect it from any cuts, moisture or ultraviolet light. Avoid corrosive, overheated or refrigerated atmospheres.





**IMPORTANT: Do not disassemble sleeve. If the Lad-Saf™ X3 Detachable Cable Sleeve is disassembled or tampered with in any manner it may result in serious injury or death.**

## 7.0 SPECIFICATIONS

- 7.1 All top and bottom brackets, cable guides, carrier cable, and fasteners are made of galvanized or stainless steel. Contact DBI-SALA for material specification details if required. The Lad-Saf™ system, when installed according to the user instructions, meets OSHA, ANSI (A14.3) and CSA (Z259.2.5) requirements.

## 8.0 LABELING, ID/LOT NUMBERS, MANUFACTURING DATES

The Lad-Saf™ Flexible Cable Ladder Safety System label (see Figure 11) must be securely attached and fully legible:

1. Acceptable cable sleeve part numbers associated with flexible cable size.
2. **WARNING:** Failure to heed warnings may result in serious injury or death. Manufacturer's instructions supplied with this product at time of shipment must be followed for proper installation, use, inspection and maintenance. Unauthorized alteration or substitution of system elements or components is prohibited. Do not use system with incompatible safety sleeves. Before each use inspect system visually for defects. Formally inspect system in accordance with instructions at least annually. Refer to instructions for information on periodic formal inspections. Minimum spacing of users of this system is 20 ft.
3. Serial Number
4. RFID Tag
5. System Installation Date
6. Proof Test Completed
7. Inspected By
8. Date of Inspection
9. Inspections
10. System Capacity

The following Lad-Saf™ X3 Detachable Cable Sleeve labels must be securely attached and fully legible:

Label in Figure 12:

1. Model Number
2. Serial Number
3. **WARNING:** Failure to heed warnings may result in serious injury or death. Read and follow manufacturer's instructions supplied with this product before use. Use only with DBI-SALA approved system and harness. Inspect before each use. Attach sleeve to frontal D-ring on harness with DBI-SALA supplied carabiner.

Label in Figure 13:

1. UP orientation of sleeve body.

Handle/Energy Absorber in Figure 14:

1. ID/Lot Number

Label in Figure 15:

1. Maximum distance allowed between system cable and harness attachment point is 9 inches (23 cm).
2. Do not use with Lanyard.





## LIMITED LIFETIME WARRANTY

**Warranty to End User:** D B Industries, Inc., dba CAPITAL SAFETY USA ("CAPITAL SAFETY") warrants to the original end user ("End User") that its products are free from defects in materials and workmanship under normal use and service. This warranty extends for the lifetime of the product from the date the product is purchased by the End User, in new and unused condition, from a CAPITAL SAFETY authorized distributor. CAPITAL SAFETY'S entire liability to End User and End User's exclusive remedy under this warranty is limited to the repair or replacement in kind of any defective product within its lifetime (as CAPITAL SAFETY in its sole discretion determines and deems appropriate). No oral or written information or advice given by CAPITAL SAFETY, its distributors, directors, officers, agents or employees shall create any different or additional warranties or in any way increase the scope of this warranty. CAPITAL SAFETY will not accept liability for defects that are the result of product abuse, misuse, alteration or modification, or for defects that are due to a failure to install, maintain, or use the product in accordance with the manufacturer's instructions.

CAPITAL SAFETY'S WARRANTY APPLIES ONLY TO THE END USER. THIS WARRANTY IS THE ONLY WARRANTY APPLICABLE TO OUR PRODUCTS AND IS IN LIEU OF ALL OTHER WARRANTIES AND LIABILITIES, EXPRESSED OR IMPLIED. CAPITAL SAFETY EXPRESSLY EXCLUDES AND DISCLAIMS ANY IMPLIED WARRANTIES OF MERCHANTABILITY OR FITNESS FOR A PARTICULAR PURPOSE, AND SHALL NOT BE LIABLE FOR INCIDENTAL, PUNITIVE OR CONSEQUENTIAL DAMAGES OF ANY NATURE, INCLUDING WITHOUT LIMITATION, LOST PROFITS, REVENUES, OR PRODUCTIVITY, OR FOR BODILY INJURY OR DEATH OR LOSS OR DAMAGE TO PROPERTY, UNDER ANY THEORY OF LIABILITY, INCLUDING WITHOUT LIMITATION, CONTRACT, WARRANTY, STRICT LIABILITY, TORT (INCLUDING NEGLIGENCE) OR OTHER LEGAL OR EQUITABLE THEORY.



Global Leader in Fall Protection

### USA

3833 SALA Way  
Red Wing, MN 55066-5005  
Toll Free: 800.328.6146  
Phone: 651.388.8282  
Fax: 651.388.5065  
solutions@capitalsafety.com

### Brazil

Rua Anne Frank, 2621  
Boqueirão Curitiba PR  
81650-020  
Brazil  
Phone: 0800-942-2300  
brasil@capitalsafety.com

### Mexico

Calle Norte 35, 895-E  
Col. Industrial Vallejo  
C.P. 02300 Azcapotzalco  
Mexico D.F.  
Phone: (55) 57194820  
mexico@capitalsafety.com

### Colombia

Compañía Latinoamericana de Seguridad S.A.S.  
Carrera 106 #15-25 Interior 105 Manzana 15  
Zona Franca - Bogotá, Colombia  
Phone: 57 1 6014777  
servicioalcliente@capitalsafety.com

### Canada

260 Export Boulevard  
Mississauga, ON L5S 1Y9  
Phone: 905.795.9333  
Toll-Free: 800.387.7484  
Fax: 888.387.7484  
info.ca@capitalsafety.com

### EMEA (Europe, Middle East, Africa)

*EMEA Headquarters:*  
5a Merse Road  
North Moons Moat  
Redditch, Worcestershire  
B98 9HL UK  
Phone: + 44 (0)1527 548 000  
Fax: + 44 (0)1527 591 000  
csgne@capitalsafety.com

### France:

Le Broc Center  
Z.I. 1re Avenue - BP15  
06511 Carros Le Broc Cedex  
France  
Phone: + 33 04 97 10 00 10  
Fax: + 33 04 93 08 79 70  
information@capitalsafety.com

### Australia & New Zealand

95 Derby Street  
Silverwater  
Sydney NSW 2128  
Australia  
Phone: +(61) 2 8753 7600  
Toll-Free : 1800 245 002 (AUS)  
Toll-Free : 0800 212 505 (NZ)  
Fax: +(61) 2 8753 7603  
sales@capitalsafety.com.au

### Asia

*Singapore:*  
69, Ubi Road 1, #05-20  
Oxley Bizhub  
Singapore 408731  
Phone: +65 - 65587758  
Fax: +65 - 65587058  
inquiry@capitalsafety.com

### Shanghai:

Rm 1406, China Venturetech Plaza  
819 Nan Jing Xi Rd,  
Shanghai 200041, P R China  
Phone: +86 21 62539050  
Fax: +86 21 62539060  
inquiry@capitalsafety.cn

[www.capitalsafety.com](http://www.capitalsafety.com)

