



Instructions for the following series products:
Wire Rope Horizontal Lifeline
(See back page for specific model numbers.)

User Instruction Manual Sayline™ Wire Rope Horizontal Lifeline

This manual is provided as the Manufacturer's Instructions, and should be used as part of an employee training program as required by OSHA.

Figure 1 Typical Horizontal Lifeline Installation

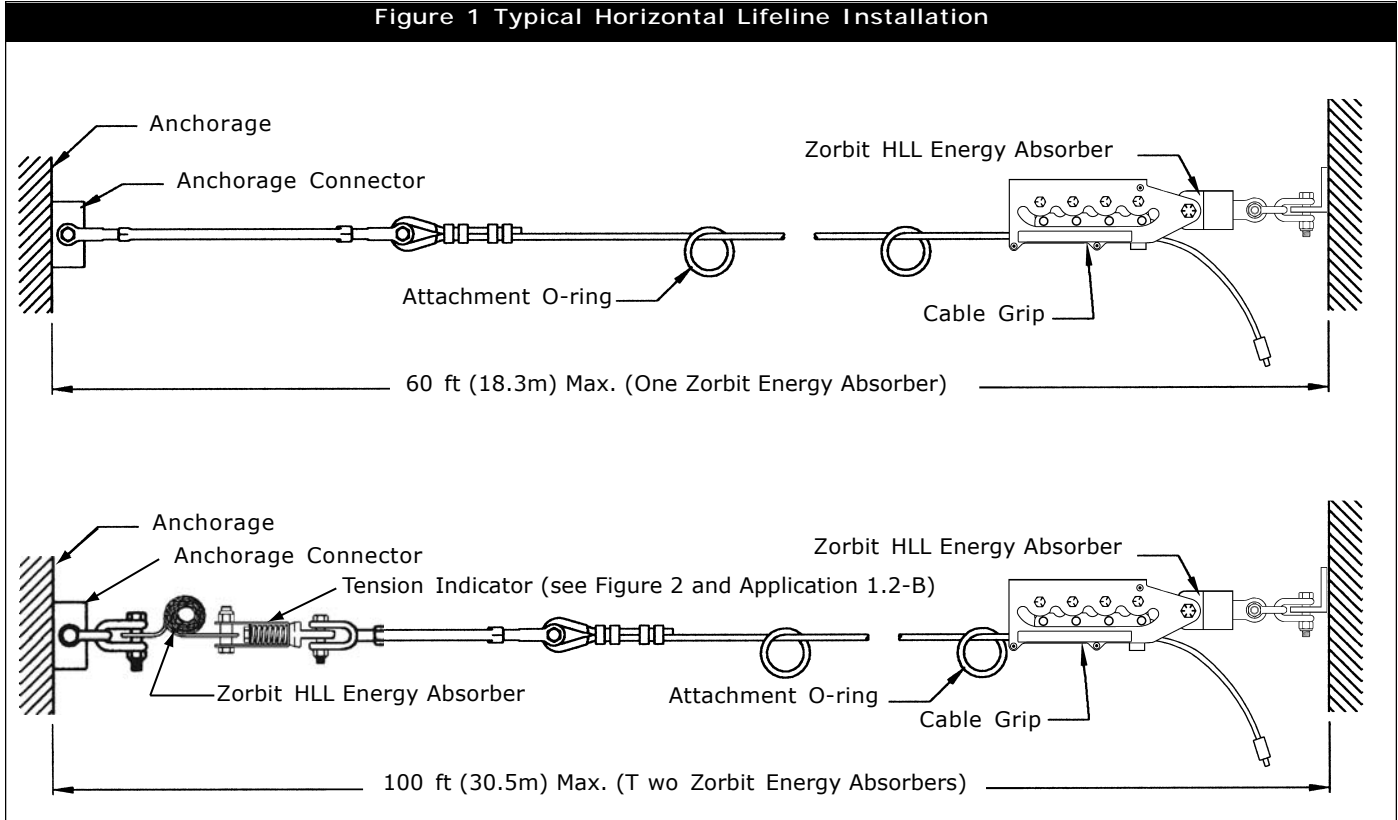

⚠ WARNING: Do not rigidly mount Zorbit HLL Energy Absorber to structure or stanchion. May cause failure due to bending stress. Mount so Zorbit can pivot and move freely.

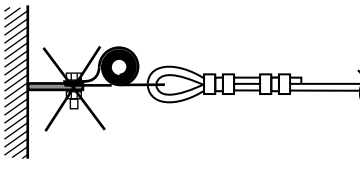

⚠ WARNING: This product is part of a fall protection system. The users must read and follow the manufacturer's instructions for each component of the system. These instructions must be provided to the users of this equipment. The users must read and understand these instructions before using this equipment. Manufacturer's instructions must be followed for proper use and maintenance of this product. Alterations or misuse of this product, or failure to follow instructions, may result in serious injury or death.

IMPORTANT: If you have questions on the use, care, or suitability of this equipment for your application, contact DBI-SALA.

1.0 APPLICATION

- 1.1 **PURPOSE:** The Sayline Wire Rope Horizontal Lifeline System is designed for use as an anchoring means for one or two personal fall arrest systems (PFAS). Use the Sayline Horizontal Lifeline (HLL) where horizontal mobility and fall protection is required. The Tension Indicator is intended to be used as an element within a horizontal lifeline subsystem incorporating a Zorbit energy absorber. See Figure 2 for parts identification.
- 1.2 **LIMITATIONS:** The following limits apply to the installation and use of Sayline Wire Rope Horizontal Lifeline System. Other limitations may apply:

IMPORTANT: OSHA regulations state that horizontal lifelines shall be installed and used under the supervision of a qualified person (see below for definition) as part of a complete personal fall arrest system that maintains a safety factor of at least two.

Qualified Person: An individual with a recognized degree or professional certificate, and extensive knowledge and experience in the subject field, who is capable of design, analysis, evaluation, and specification in the subject work, project, or product. Refer to OSHA 1910.66, 1926.32, and 1926.502.

- A. **HORIZONTAL LIFELINE SPAN:** The maximum horizontal lifeline span length is 60 feet (18.3 m) with a single Zorbit HLL energy absorber, or 100 feet (30.5 m) when a Zorbit HLL energy absorber is installed on each end of the system. See Figure 1. The span length must be reduced when clearance is limited. See section 3.0 for clearance information.
- B. **TENSION INDICATOR:** The Tension Indicator is to be used with DBI-SALA horizontal lifeline systems that incorporate a Zorbit energy absorber (See Figures 1 and 2). Do not use the Tension Indicator on systems that do not have at least one Zorbit energy absorber.
- C. **ANCHORAGES:** The Sayline horizontal lifeline must be installed on anchorages that meet the requirements specified section 2.4.
- D. **SYSTEM CAPACITY:** The maximum capacity of the Sayline horizontal lifeline is two persons. The maximum weight of each person, including tools and clothing, is 310 lbs. (141 kg).
- E. **CONNECTING SUBSYSTEM:** Each person's connecting subsystem must limit fall arrest forces to 900 lbs. (4.0 kN) or less. See section 2.5.
- F. **FREE FALL:** Rig and use the personal fall arrest system such that the maximum potential free fall does not exceed government regulatory and subsystem manufacturer's requirements. See section 3.0 and subsystem manufacturer's instructions for more information.
- G. **SWING FALLS:** See Figure 3. Swing falls occur when the anchorage point is not directly overhead. The force of striking an object in a swing fall may cause serious injury or death. Minimize swing falls by working as directly below the anchorage point as possible. Do not permit a swing fall if injury could occur. Swing falls will significantly increase the clearance required when a self retracting lifeline or other variable length connecting subsystem is used. If a swing fall situation exists in your application, contact DBI-SALA before proceeding.
- H. **FALL CLEARANCE:** There must be sufficient clearance below the worker to arrest a fall before striking the lower level or obstruction. See section 3.0 for required clearance information.
- I. **BODY SUPPORT:** Zorbit HLL energy absorbers must only be used with personal fall arrest systems incorporating a full body harness.

Figure 2 Tension Indicator

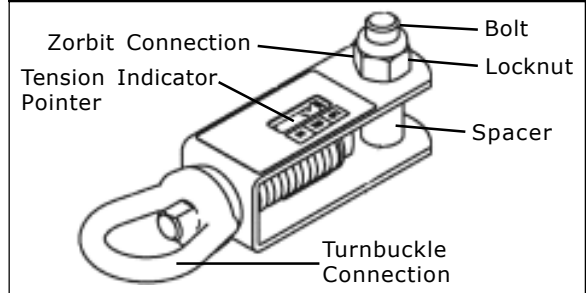
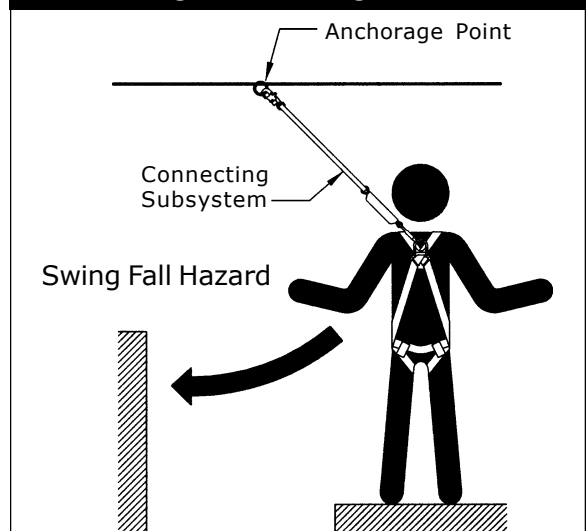

Figure 3 - Swing Falls



J. **PHYSICAL AND ENVIRONMENTAL HAZARDS:** Use of this equipment in areas with physical or environmental hazards may require additional precautions to reduce the possibility of injury to the user or damage to the equipment. Hazards may include, but are not limited to; heat, chemicals, corrosive environments, high voltage power lines, gases, moving machinery, and sharp edges. Contact DBI-SALA if you have questions about using this equipment where physical or environmental hazards exist.

K. **TRAINING:** This equipment must be installed and used by persons trained in the correct application and use of this equipment. See section 4.0.

1.3 **APPLICABLE STANDARDS:** Refer to national standards, including ANSI Z359.1-1992 and local, state, and federal (OSHA 1910.66 and 1926.502) and CSA Z259.13 in Canada requirements for more information on personal fall arrest systems and associated components.

2.0 SYSTEM REQUIREMENTS

2.1 **PERSONAL FALL ARREST SYSTEM COMPONENTS:** The Sayflite horizontal lifeline must be used with DBI-SALA approved components and subsystems. Non-approved components may be incompatible, and could affect the safety and reliability of the complete system. Personal fall arrest components used with this system must meet all applicable OSHA and ANSI requirements. A full body harness must be used with this system. The connecting subsystem between the harness and horizontal lifeline must limit fall arrest forces to 900 lbs. (4.0 kN) or less.

2.2 **PERSONAL FALL ARREST SYSTEM CONNECTORS:** Connectors used to attach to the attachment O-ring on the horizontal lifeline (hooks, carabiners, D-rings) must support at least 5,000 lbs. (22.2kN). Connectors and attachment elements must be compatible in size, shape, and strength. Non-compatible connectors may unintentionally disengage (roll-out). Do not use non-locking connectors with this system.

2.3 **ANCHORAGE CONNECTORS:** Connectors used to attach the horizontal lifeline to end anchors must be compatible with the connection point. The connection must be positive; and, with connecting elements, capable of sustaining a 5,000 lbs. (22.2 kN) load without failure.

2.4 **STRUCTURE LOAD:** Structural anchorage points must be rigid, and capable of supporting at least 5,000 lbs. (22.2 kN) along the axis of the horizontal lifeline. Anchorages must also support at least 3,600 lbs. (16.0 kN) applied in all potential directions of fall arrest that are perpendicular to the axis of the horizontal lifeline. See Figure 4.

WARNING: Anchorages must be rigid. Large deformations of the anchorage will affect system performance, and may increase the required fall clearance below the system, which could result in serious injury or death.

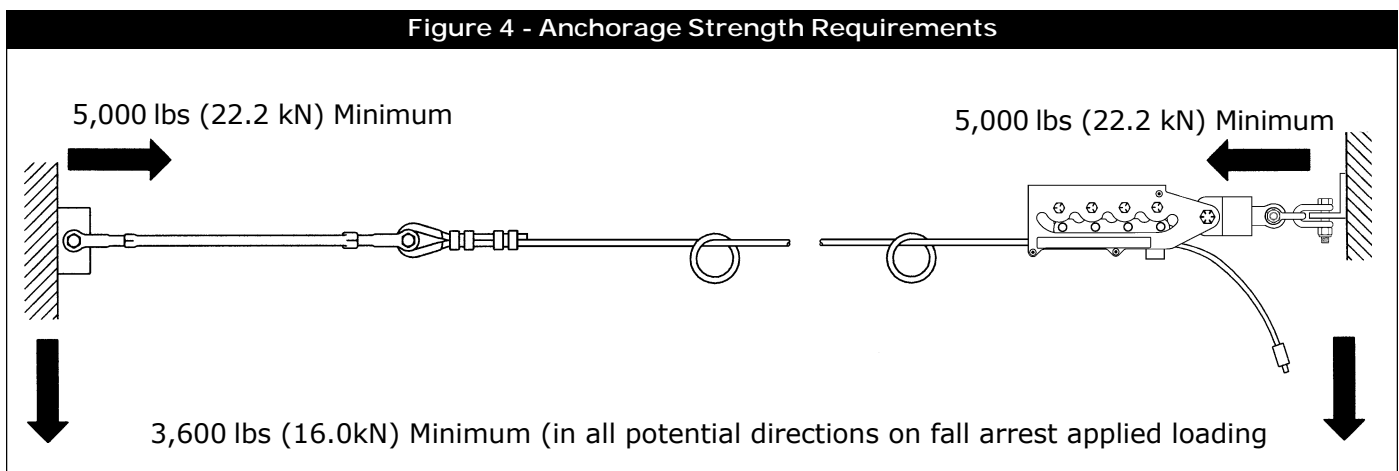

2.5 **CONNECTING SUBSYSTEM:** The connecting subsystem is the portion of the personal fall arrest system that is used to connect between the horizontal lifeline subsystem and harness fall arrest attachment element. The connecting subsystem must limit forces applied to the horizontal lifeline to 900 lbs. or less.

Figure 5 - Cleanance Evaluation Using DBI-SALA Energy Absorbing Lanyards

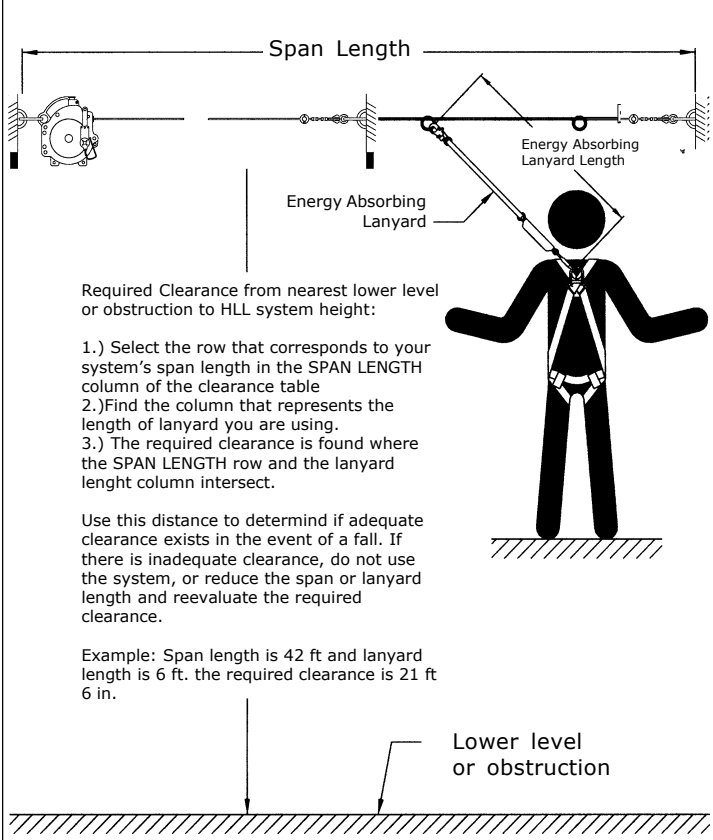

Clearance Table DBI-SALA Energy Absorbing Lanyards					
Span Length Dimensions in Feet (meters in paranthesis)		Length of Energy Absorbing Lanyard Dimensions in Ft.-In. (meters in paranthesis)			
Greater than	Less than or equal to	3-0 (.9)	4-0 (1.2)	5-0 (1.5)	6-0 (1.8)
0 (0)	10 (3.1)	14-11 (4.6)	15-11 (4.9)	16-11 (5.2)	17-11 (5.5)
10 (3.1)	15 (4.6)	15-7 (4.8)	16-7 (5.1)	17-7 (5.4)	18-7 (5.7)
15 (4.6)	20 (6.1)	16-2 (4.9)	17-2 (5.2)	18-2 (5.5)	19-2 (5.8)
20 (6.1)	25 (7.8)	16-11 (5.2)	17-11 (5.5)	18-11 (5.8)	19-11 (6.1)
25 (7.8)	30 (9.1)	17-6 (5.3)	18-6 (5.6)	19-6 (5.9)	20-6 (6.3)
30 (9.1)	35 (10.7)	18-2 (5.5)	19-2 (5.8)	20-2 (6.2)	21-2 (6.5)
35 (10.7)	40 (12.2)	18-10 (5.7)	19-10 (6.1)	20-10 (6.4)	21-10 (6.7)
40 (12.2)	45 (13.7)	19-6 (5.9)	20-6 (6.3)	21-6 (6.6)	22-6 (6.9)
45 (13.7)	50 (15.2)	20-1 (6.1)	21-1 (6.4)	22-1 (6.7)	23-1 (7.0)
50 (15.2)	55 (16.8)	20-10 (6.4)	21-10 (6.7)	22-10 (7.0)	23-10 (7.3)
55 (16.8)	60 (18.3)	21-5 (6.5)	22-5 (6.8)	23-5 (7.1)	24-5 (7.4)
60 (18.3)	65 (19.8)	22-1 (6.7)	23-1 (7.0)	24-1 (7.3)	25-1 (7.7)
65 (19.8)	70 (21.3)	22-8 (6.9)	23-8 (7.2)	24-8 (7.5)	25-8 (7.8)
70 (21.3)	75 (22.9)	23-5 (7.1)	24-5 (7.4)	25-5 (7.8)	26-5 (8.1)
75 (22.9)	80 (24.4)	24-0 (7.3)	25-0 (7.6)	26-0 (7.9)	27-0 (8.2)
80 (24.4)	85 (25.9)	24-8 (7.5)	25-8 (7.8)	26-8 (8.1)	27-8 (8.4)
85 (25.9)	90 (27.4)	25-4 (7.7)	26-4 (8.0)	27-4 (8.3)	28-4 (8.6)
90 (27.4)	95 (29.0)	26-0 (7.9)	27-0 (8.2)	28-0 (8.5)	29-0 (8.7)
95 (29.0)	100 (30.5)	26-7 (8.1)	27-7 (8.4)	28-7 (8.7)	29-7 (9.0)

Figure 6 - Cleanance Evaluation Using DBI-SALA Self Retracting Lifelines

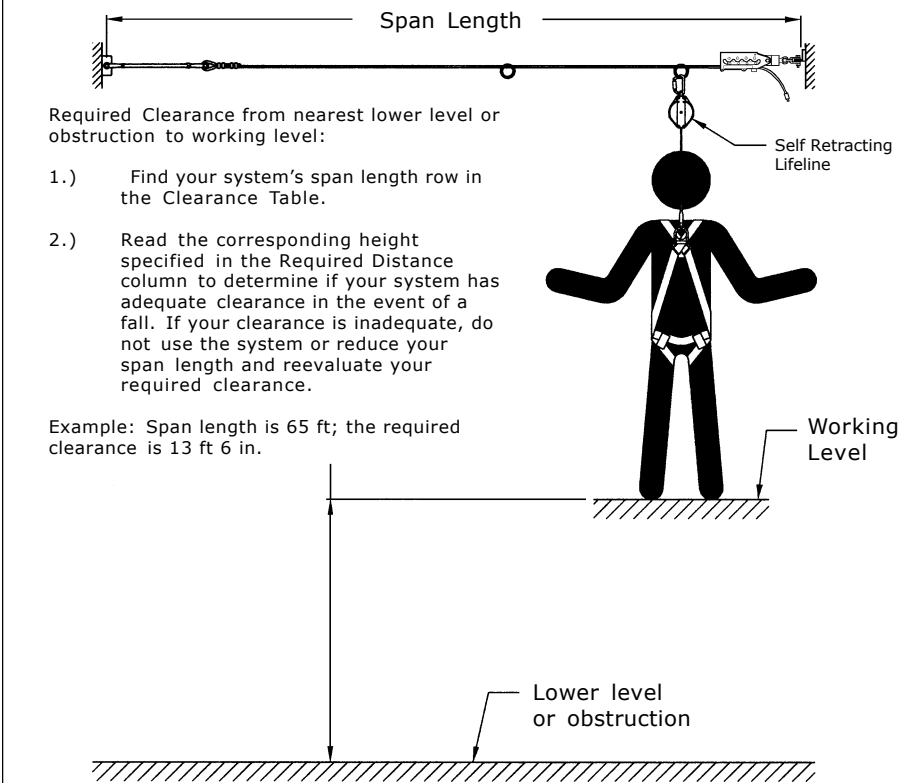

WARNING: This information only applies when the HLL and SRL are located above the level of the harness attachment point and the user is standing.

Clearance Table DBI-SALA Self Retracting Lifelines		
Span Length Dimensions in Feet (meters in paranthesis)		Required Clearance Dimensions in Ft.-In. (meters in paranthesis)
Greater than	Less than or equal to	
0 (0)	10 (3.1)	6-11 (2.1)
10 (3.1)	20 (6.1)	8-0 (2.4)
20 (6.1)	30 (9.1)	9-1 (2.8)
30 (9.1)	40 (12.2)	10-2 (3.1)
40 (12.2)	50 (15.2)	11-4 (3.5)
50 (15.2)	60 (18.3)	12-5 (3.8)
60 (18.3)	70 (21.3)	13-6 (4.1)
70 (21.3)	80 (24.4)	14-7 (4.4)
80 (24.4)	90 (27.4)	15-8 (4.8)
90 (27.4)	100 (30.5)	16-10 (5.1)

3.0 OPERATION AND USE

WARNING: Do not alter or intentionally misuse this equipment. Use caution when using this equipment around moving machinery, electrical and chemical hazards, and sharp edges.

WARNING: Consult your doctor if there is reason to doubt your fitness to absorb the impact from a fall arrest. Age and fitness can affect your ability to withstand fall arrest forces. Pregnant women and minors must not use this system.

- 3.1 **BEFORE EACH USE** inspect this equipment according to steps listed in section 5.3. Do not use this equipment if inspection reveals an unsafe or defective condition. Plan your use of the fall protection system prior to exposing workers to dangerous situations. Consider all factors affecting your safety before using this system.
- A. Read and understand all manufacturer's instructions for each component of the personal fall arrest system. All DBI-SALA harnesses and connecting subsystems are supplied with separate user instructions. Keep all instructions for future reference.
 - B. Review sections 1.0 and 2.0 to ensure system limitations and other requirements have been adhered to. Review applicable information regarding system clearance criteria, and ensure changes have not been made to the system installation (i.e. length), or occurred at the job site, that could affect the required fall clearance. Do not use the system if changes are required.
- 3.2 **SYSTEM INSTALLATION:** Figure 1 shows typical horizontal lifeline system installations. When using an energy absorbing lanyard to connect to the system, the end anchorages must be located at a height which will limit the free fall to 6 feet (1.8 m). When using a self retracting lifeline (SRL) to connect to the system, the end anchorages must be located above the user. The SRL, when fully retracted, must be above the harness attachment level. The horizontal lifeline system should be positioned at a level that will minimize free fall while allowing ease of use. The horizontal lifeline should be positioned near the work location to minimize swing fall hazards. The connecting subsystem length should be kept as short as possible to reduce the potential free fall and required clearance distance. Both anchorages must be installed at approximately the same elevation, so that the horizontal lifeline system is not sloped more than five degrees.

Step 1. Determine the locations of the end anchorages and evaluate their strengths in accordance with section 2.4. Determine the span length and evaluate the required clearance using Figure 5 or 6. Figures 5 and 6 apply to one or two users connected to the system.

Step 2. Install the horizontal lifeline to anchorage connectors using the shackles, bolts, and nuts provided. The Tension Indicator should be installed between a Zorbit energy absorber and turnbuckle. See Figure 1. Refer to manufacturer's instructions provided with the anchorage connectors for installation requirements. The horizontal lifeline system may be secured directly to the anchorage if the anchorage incorporates a connecting element that meets the requirements specified in section 2.3. Tighten bolts and nuts used to connect the system to the anchorage connectors.

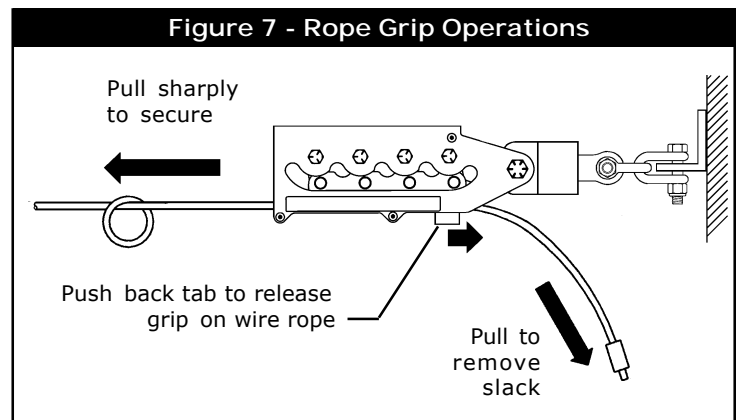

NOTE: Ensure the spacer is installed on the bolt at the Zorbit connection. See Figure 2.

Step 3: See Figure 7. Remove excess slack by pulling the wire rope through the cable grip. After the slack is removed, pull back sharply on the wire rope to ensure it is secured in the cable grip. Tighten the wire rope by turning the turnbuckle at the opposite end of the system. The unrestrained turnbuckle jaw end must be prevented from turning to prevent twisting of the wire rope. The wire rope must be tensioned until the sag on the system is six inches or less, with no weight on the wire rope. The turnbuckle cannot overtension the wire rope.

If a Tension Indicator is used (with a Zorbit energy absorber), tension the lifeline until the red pointer on the Tension Indicator is within the "OK" range of the label. See Figure 8.

- Step 4:** If slack is needed to make an adjustment to the system, or for ease in removing the system, press back toward the anchor on the release tab on the bottom of the cable grip device as shown in Figure 7. After the lifeline has been tensioned, it may be necessary to tap the release tab with a hammer to disengage the cable grip device from the lifeline.

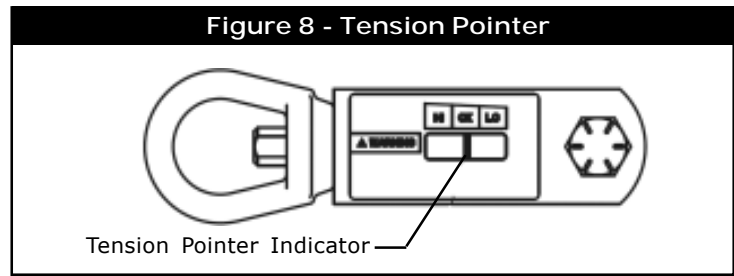

3.3 OPERATION:

- A. **PERSONAL FALL ARREST SYSTEM COMPONENTS:** Inspect and don the full body harness according to manufacturer's instructions. Attach the connecting subsystem (energy absorbing lanyard or SRL) to the dorsal connection on the harness.
- B. **CONNECTING TO THE HLL SYSTEM:** Approach the work area using the appropriate access equipment. Connect the personal fall arrest system to one of the attachment O-rings on the HLL. Connectors must meet all compatibility and strength requirements.
- C. **HAZARDOUS SITUATIONS:** Do not take unnecessary risks, such as jumping or reaching too far from the edge of the working surface. Do not allow the connecting subsystem to pass under arms or between feet. To avoid inadequate clearance, do not climb above the HLL. To avoid swing fall hazards, do not work too far from either side of the HLL.
- D. **TWO PERSONS CONNECTED TO THE HLL:** When a person falls while connected to the HLL, the system will deflect. If two persons are connected to the same HLL, and one person falls, the second person may be pulled off the working surface due to deflection. The potential for the second person falling increases as the HLL span length increases. The use of independent HLL systems for each person, or shorter span length, is recommended to minimize the potential of the second person falling.
- E. **FREE FALL:** The personal fall arrest system must be rigged to limit free falls to 6 feet (1.8 m) or less when using an energy absorbing lanyard, or such that the SRL is overhead and without slack, according to OSHA requirements.
- F. **SHARP EDGES:** Avoid working where the connecting subsystem or other system components will be in contact with, or abrade against, unprotected sharp edges. If working around sharp edges is unavoidable, a protective cover must be used to prevent cutting of the PFAS components.
- G. **IN THE EVENT OF A FALL:** The responsible party must have a rescue plan and the ability to implement a rescue. Tolerable suspension time in a full body harness is limited, so a prompt rescue is critical.

IMPORTANT: Use care when handling an expended Z orbit energy absorber. The tearing of the energy absorber material produces extremely sharp edges.

- H. **RESCUE:** With the number of potential scenarios for a worker requiring rescue, an on site rescue team is beneficial. The rescue team is given the tools, both in equipment and techniques, so it can perform a successful rescue. Training should be provided on a periodic basis to ensure rescuers proficiency.
- 3.4 **SYSTEM REMOVAL:** When no longer required, the HLL system should be removed from the job site. To slacken the HLL, loosen the turnbuckle until tension is removed from the wire rope. Disconnect the HLL system from the anchorages. Ensure there are no knots or kinks in the wire rope before storage.

4.0 TRAINING

- 4.1 It is the responsibility of all users of this equipment to understand these instructions, and are trained in the correct installation, use, and maintenance of this equipment. These individuals must be aware of the consequences of improper installation or use of this equipment. This user manual is not a substitute for a comprehensive training program. Training must be provided on a periodic basis to ensure proficiency of the users.

5.0 INSPECTION

- 5.1 **BEFORE EACH INSTALLATION:** Inspect the Zorbit HLL energy absorber, kit components, and other system components according to these or other manufacturer's instructions. System components must be formally inspected by a qualified person (other than the user) at least annually. Formal inspections should concentrate on visible signs of deterioration or damage to the system components. Items found to be defective must be replaced. Do not use components if inspection reveals an unsafe or defective condition. Record results of each inspection in the inspection and maintenance log in section 9.0 of this manual.

- 5.2 **INSTALLED SYSTEMS:** An inspection of the HLL system by a qualified person must be completed after the system is installed. The system must be periodically inspected by a qualified person when left installed for an extended period, and prior to each day's use. Periodic inspections should be performed at least monthly, or more frequently when site conditions and use warrant. Inspections of installed systems should include the inspection steps listed in section 5.3.

5.3 BEFORE SYSTEM USE:

- Step 1. Inspect the turnbuckle for damage. Ensure sufficient threads are engaged into the turnbuckle body. Look for any cracks or deformities in the metal. Inspect metal components for rust or corrosion that may affect their strength or operation.
- Step 2. Inspect the wire rope for rust, corrosion, broken wires, or other obvious faults. Inspect the HLL for proper tension. Inspect all hardware (fasteners, shackles, wire rope cable clips, etc.) securing the HLL assembly to ensure they are present and properly installed.
- Step 3. Inspect the Zorbit HLL energy absorber for extension or deformities. There should be no tearing of the metal between holes in the Zorbit coiled section. Extended Zorbit HLL energy absorbers must be removed from service and destroyed, or marked for training only. Inspect securing hardware for strength and function.
- Step 4. Inspect the cable grip side plates for damage such as cracks, dents or distortion. Inspect for signs of corrosion. Check that the lifeline is gripped securely. Do not use if inspection reveals an unsafe condition.
- Step 5. Grasp the cable at a point near the cable grip and pull sharply away from the cable grip to ensure that the wire rope is secured in the grip.
- Step 6. Inspect system labels. The labels must be present and fully legible. See section 8.0. Replace labels if missing or illegible.

IMPORTANT: If this equipment is subjected to the forces of a fall arrest, it must be removed from service and destroyed, or returned to DBI-SALA for inspection or repair.

- 5.4 If inspection reveals an unsafe or defective condition, remove unit from service and destroy, or contact DBI-SALA for possible repair.
- 5.5 **USER EQUIPMENT:** Inspect harnesses and energy absorbing lanyards or SRL's used with the HLL system according to manufacturer's instructions.

6.0 MAINTENANCE, SERVICE, STORAGE

- 6.1 The Sayflite components require no scheduled maintenance, other than repair or replacement of items found defective during inspection. See section 5.0. If components become heavily soiled with grease, paint, or other substances, clean with appropriate cleaning solutions. Do not use caustic chemicals that could damage system components.
- 6.2 **USER EQUIPMENT:** Maintain, service, and store user equipment according to manufacturer's instructions.

7.0 SPECIFICATIONS

7.1 MATERIALS:

Zorbit Energy Absorber: Stainless steel
Tension Indicator: Zinc plated steel
Wire Rope: 3/8 inch diameter, 7x19 galvanized steel
Bolts: Grade 5 or Grade 8 zinc plated steel
Nuts: Zinc plated steel
Shackles: Galvanized steel, 5,000 lbs. (2.22 kN) minimum tensile strength
Thimbles: Galvanized steel
Turnbuckle: Galvanized steel, 5,000 lbs. (22.2 kN) minimum tensile strength
Cable Clips: Galvanized steel

7.2 ENERGY ABSORBER PERFORMANCE:

Peak Dynamic Pullout Load: 2,500 lbs. (11.1 kN)
Average Dynamic Pullout Load: 2,000 lbs. (8.9 kN)
Maximum Pullout: 48.5 inches (1.2 m)
Minimum Tensile Strength: 5,000 lbs. (22.2 kN)
Patents Pending

8.0 LABELING

8.1 These labels must be present and fully legible:

Sayline Horizontal Lifeline Termination
Use with 3/8" dia. 7x19 galv wire rope only
Working Load Limit: 2,500 lbs.

USE: Push cams to rear to adjust, release to engage lifeline. Pull sharply on lifeline to ensure grip is secure. Use caution near hazardous thermal, electrical or chemical sources.

INSPECTION: Inspect spring function before each use. Do not use if side plates are deformed. Do not use if inspection reveals other unsafe condition.

9501463 REV C

Cable Grip Use

3965 PEPIN AVE
RED WING, MN 55066
PH. 800-328-6146

MODEL NO. _____

MFRD (YR/MO) /LOT: _____

▲ WARNING MANUFACTURER'S INSTRUCTIONS SUPPLIED WITH THIS PRODUCT AT TIME OF SHIPMENT MUST BE FOLLOWED FOR PROPER USE. FAILURE TO FOLLOW INSTRUCTIONS MAY RESULT IN SERIOUS INJURY OR DEATH.

Cable Grip Warning

▲ WARNING MANUFACTURER'S INSTRUCTIONS SUPPLIED WITH THIS PRODUCT AT TIME OF SHIPMENT MUST BE FOLLOWED FOR PROPER USE, MAINTENANCE, AND INSPECTION. ENSURE HORIZONTAL LIFELINE IS LOCATED AT AN ELEVATION WHICH WILL LIMIT FREE FALLS TO A MAXIMUM OF 6 FEET WHEN USING SHOCK ABSORBING LANYARDS, AND LOCATED OVERHEAD WHEN USING SELF RETRACTING LIFELINES. SHOCK ABSORBING LANYARDS AND SELF RETRACTING LIFELINES USED TO CONNECT TO THIS SYSTEM MUST LIMIT MAXIMUM ARRESTING FORCES TO 900 LBS. THIS EQUIPMENT MUST BE INSTALLED AND USED UNDER THE SUPERVISION OF A QUALIFIED PERSON. MAKE ONLY COMPATIBLE CONNECTIONS. EXERCISE CAUTION USING THIS EQUIPMENT NEAR HAZARDOUS THERMAL, ELECTRICAL, OR CHEMICAL SOURCES. ALTERATION OR MISUSE OF THIS PRODUCT, OR FAILURE TO FOLLOW INSTRUCTIONS MAY RESULT IN SERIOUS INJURY OR DEATH.

3965 Pepin Avenue
Red Wing, MN 55066
(800) 328-6146

MFRD	XX	XX	XX	XX	XX	XX
SERIAL NO.	XXXXXX	XXXXXX	XXXXXX	XXXXXX	XXXXXX	XXXXXX

MEETS OSHA AND ANSI
A10.14-1991 TYPE I REQUIREMENTS.

MATERIAL DESIGNATION:
(IDENTIFIED AFTER MODEL NO.)
P=POLYESTER - N=NYLON
C=CABLE - W=CHAIN
K=ARAMID

CAP.: 310 LBS. MAX.
2 USERS
LENGTH (FT.) IS DENOTED BY NUMBER AFTER MATERIAL DESIGNATION.
MADE IN THE U.S.A.

Horizontal Lifeline Labels

▲ WARNING

THIS HORIZONTAL LIFELINE ENERGY ABSORBER (EAHL) MUST ONLY BE USED AS PART OF A DBI/SALA HORIZONTAL LIFELINE SUBSYSTEM (HLLSS). OR, AS PART OF A COMPLETE PERSONAL FALL ARREST SYSTEM INCORPORATING A HLLSS WHICH MAINTAINS A SAFETY FACTOR OF AT LEAST TWO, DESIGNATED, INSTALLED AND USED UNDER THE SUPERVISION OF A QUALIFIED PERSON. REFERENCE OSHA REGULATIONS. DO NOT USE AS A PERSONAL ENERGY ABSORBER. MANUFACTURER'S INSTRUCTIONS SUPPLIED WITH THIS PRODUCT AT TIME OF SHIPMENT MUST BE FOLLOWED. FAILURE TO DO SO COULD RESULT IN SERIOUS INJURY OR DEATH.

ZORBITTM
ENERGY ABSORBER FOR HORIZONTAL LIFELINE SYSTEMS

SPECIFICATIONS: MATERIAL - STAINLESS STEEL; PEAK DYNAMIC PULLOUT LOAD - 2500 LBS.; AVERAGE DYNAMIC PULLOUT LOAD - 2000 LBS.; MAXIMUM PULLOUT - 48.5 INCHES; ULTIMATE STRENGTH - 5000 LBS.; MODEL - 7401013

PATENT PENDING
USA: 3965 PEPIN AVE.
RED WING, MN 55066
(800) 328-6146
CANADA: 260 EXPORT BLVD.
MISSISSAUGA, ONTARIO
CANADA, L5S 1Y9
(800) 387-7484

Zorbit Energy Absorber Label

9501894 REV A

LO

OK

HI

Lifeline Tension

www.capitalsafety.com

SPECIFICATIONS
MATERIAL: STEEL
ULTIMATE STRENGTH: 5000 LBS

USA: (800) 328-6146
Canada: (800) 387-7484

Tension Indicator ID Label

9501929 REV A

Lifeline Tension

HI

OK

LO

▲ WARNING

This tension indicating device must only be used as part of a DBI-SALA horizontal lifeline system or as part of a complete horizontal lifeline system which maintains a safety factor of at least two, designed, installed and used under the supervision of a qualified person. Reference OSHA regulations. Manufacturer's instructions supplied with this product at time of shipment must be read and followed. Failure to do so could result in serious injury or death. Do not remove this label.

Tension Indicator Warning Label

This instruction applies to the following models:

7602002
7602010
7602020
7602030
7602040
7602050
7602060
7602070
7602080
7602090
7602100
7603300
7603301
7603302
7603303
7603304
7603307
7603308

Additional model numbers may appear on the next printing of these instructions



A Capital Safety Company

USA
3833 SALA Way
Red Wing, MN 55066-5005
Toll Free: 800-328-6146
Phone: (651) 388-8282
Fax: (651) 388-5065
www.capitalsafety.com

Canada
260 Export Boulevard
Mississauga, Ontario L5S 1Y9
Toll Free: 800-387-7484
Phone: (905) 795-9333
Fax: (905) 795-8777
www.capitalsafety.com

This manual is available for download at www.capitalsafety.com.



Form: 5911865
Rev: C