



Compliance In A Can

This manual is intended to meet the Manufacturer's Instructions as required by ANSI Z359.1 and should be used as part of an employee training program as required by OSHA.



Contents	
1.0 HOW TO USE THIS MANUAL	1
2.0 TRAINING	2
3.0 COMPONENT AND CONNECTOR COMPATIBILITY	2
4.0 FULL BODY HARNESS	4
5.0 VERTICAL LIFELINE AND ROPE GRAB SYSTEMS	5
6.0 SELF RETRACTING LIFELINE SYSTEMS	14
7.0 HORIZONTAL LIFELINE SYSTEMS	15
8.0 INSPECTION	18
9.0 CLEANING AND MAINTENANCE	22
10.0 SPECIFICATIONS	23
INSPECTION LOG	25

WARNING: These products are part of a personal protective, rescue, or work support system. The user must read and follow the manufacturer's instructions for each component of the system. These instructions must be provided to the user of this equipment. The user must read and understand these instructions, or have them explained to them, before using this equipment. Manufacturer's instructions must be followed for proper use and maintenance of this equipment. If any questions regarding the use of this equipment arise before or during the course of your work, contact PROTECTA

1.0 HOW TO USE THIS MANUAL

1.1 Compliance In A Can systems are packaged to include either a vertical lifeline and rope grab system, a self retracting lifeline (SRL) system, or a horizontal lifeline (HLL) system. Refer to the appropriate section of this manual for the system requirements and limitations before installing your system.

Section 4 contains instructions for Full Body Harness use. The Vertical Lifeline and Rope Grab systems instructions are located in section 5. Also refer to section 5 for instructions on installation of all the anchorage connectors. SRL system instructions are in section 6 and HLL system instructions are in section 7.

Section 8 contains instructions on how to inspect the individual elements of your system before each use and during periodic formal inspections by a competent person. A Log for recording the results of formal inspections is included in the back of this manual.

For specifications of the individual pieces of equipment, see Section 10.

1.2 This manual contains information vital to your safety, and should be kept in a safe place for use as a reference if needed. These products are part of a personal protective, rescue, or work support system. The user must read and follow the manufacturer's instructions for each component of the system. These instructions must be provided to the user of this equipment. The user must read and understand these instructions, or have them explained to them, before using this equipment. These instructions must be followed for proper use and maintenance of this equipment.

2.0 TRAINING

2.1 TRAINING: It is the responsibility of the user to assure they are familiar with these instructions, and are trained in the correct care and use of this equipment. The user must also be aware of the operating characteristics, application limits, and the consequences of improper use of this equipment.

WARNING: *Training must be conducted without exposing the trainee to a fall hazard and should be repeated on a periodic basis.*

3.0 Component and Connector Compatibility

- 3.1 COMPATIBILITY OF COMPONENTS:** PROTECTA equipment is designed for use with PROTECTA approved components and subsystems only. Substitutions or replacements made with non-approved components or subsystems may jeopardize compatibility of equipment and may affect the safety and reliability of the complete system.
- 3.2 COMPATIBILITY OF CONNECTORS:** Connectors are considered to be compatible with connecting elements when they have been designed to work together in such a way that their sizes and shapes do not cause their gate mechanisms to inadvertently open regardless of how they become oriented. Contact PROTECTA if you have any questions about compatibility.

Connectors (hooks, carabiners, and D-rings) must be capable of supporting at least 5,000 lbs. (22.2kN). Connectors must be compatible with the anchorage or other system components. Do not use equipment that is not compatible. Non-compatible connectors may unintentionally disengage. See Figure 1. Connectors must be compatible in size, shape, and strength. Self locking snap hooks and carabiners are required by ANSI Z359.1 and OSHA, and in Canada, by CSA Z259.12.

Figure 1 - Unintentional Disengagement (Roll-out)

If the connecting element that a snap hook (shown) or carabiner attaches to is undersized or irregular in shape, a situation could occur where the connecting element applies a force to the gate of the snap hook or carabiner. This force may cause the gate (of either a self-locking or a non-locking snap hook) to open, allowing the snap hook or carabiner to disengage from the connecting point.

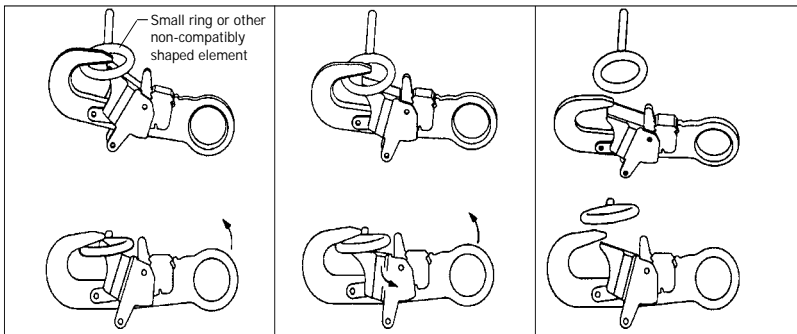

1. Force is applied to the snap hook.

2. The gate presses against the connecting ring.

3. The gate opens allowing the snap hook to slip off.

MAKING CONNECTIONS: Only use self-locking snap hooks and carabiners with this equipment. Only use connectors that are suitable to each application. Ensure all connections are compatible in size, shape and strength. Do not use equipment that is not compatible. Ensure all connectors are fully closed and locked.

PROTECTA connectors (snap hooks and carabiners) are designed to be used only as specified in each product's user's instructions. See Figure 2 for inappropriate connections. PROTECTA snap hooks and carabiners should not be connected:

- A. To a D-ring to which another connector is attached.
- B. In a manner that would result in a load on the gate.

NOTE: Large throat opening snap hooks should not be connected to standard size D-rings or similar objects which will result in a load on the gate if the hook or D-ring twists or rotates. Large throat snap hooks are designed for use on fixed structural elements such as rebar or cross members that are not shaped in a way that can capture the gate of the hook.

- C. In a false engagement, where features that protrude from the snap hook or carabiner catch on the anchor and without visual confirmation seems to be fully engaged to the anchor point.
- D. To each other.
- E. Directly to webbing or rope lanyard or tie-back (unless the manufacturer's instructions for both the lanyard and connector specifically allow such a connection).

- F. To any object which is shaped or dimensioned such that the snap hook or carabiner will not close and lock, or that roll-out could occur.

4.0 FULL BODY HARNESS:

HARNESS PURPOSE: PROTECTA full body harnesses are to be used as components in personal fall arrest, restraint, work positioning, or rescue systems.

4.1 REQUIREMENTS

- A. **FULL BODY HARNESSES** are designed to act in concert with other elements of a Personal Fall Arrest System (PFAS) and arrest a fall from height while minimizing impact load on the wearer. Users should not combine components or subsystems of the PFAS from manufacturers other than PROTECTA unless it is determined by a qualified person that they are compatible with one another. Incompatible components may interfere with the safe operation or function of the equipment.
- B. **ENVIRONMENTAL HAZARDS:** Use of this equipment with environmental hazards may require additional precautions to prevent injury to the user or damage to the equipment. Hazards may include, but are not limited to: heat, chemicals, corrosive environments, high voltage power lines, gases, moving machinery, moving vehicles and sharp edges. Contact PROTECTA if you have questions about using this equipment where environmental hazards may exist.

4.2 FULL BODY HARNESS LIMITATIONS

Full body harnesses are designed to act in concert with other elements of a Personal Fall Arrest System and arrest a fall from height while minimizing impact load on the wearer. Users should not combine components or subsystems of the PFAS from manufacturers other than PROTECTA unless it is determined by a qualified person that they are compatible with one another. Incompatible that they are compatible with one another. Incompatible components may interfere with the safe operation or function of the equipment.

- A. **HEAT:** This equipment is not designed for use in high temperature environments. Provide protection for this equipment when using near welding, metal cutting, or similar activities. Hot sparks may burn or damage this equipment. Contact PROTECTA for details on use of this equipment in high temperature environments.

4.3 DONNING THE HARNESS

- Step 1.** Grasp the harness by the dorsal D-Ring and shake until straps hang down from harness body. Make sure that the buckles are all unfastened. See Figure 3.
- Step 2.** Slip on the shoulder straps one at a time as if you were putting on a jacket. Be careful not to twist the straps.
- Step 3.** Individually adjust each shoulder strap by pulling or releasing the slack end so that the sub-pelvic strap is firmly in place under the buttocks.
- Step 4.** Pull each thigh strap through the crotch and fasten the parachute buckles by passing the male buckle through the female. Be careful not to cross or twist the straps. Adjust the tension of the thigh straps by pulling or releasing the slack end of the strap. Move the plastic keeper away from the buckle edge to ease adjustment.
- Step 5.** Attach the chest strap parachute buckle and adjust the length so that the shoulder straps are centered on each shoulder.
- Step 6.** Position the plastic strap keepers so that one is next to the parachute buckle and the other is at the far end of the excess strap. Be certain that the harness is adjusted so that:
 - 1) The dorsal D-ring is located as closely as possible to the center of the wearer's back.
 - 2) The sub-pelvic strap is located firmly in place under the wearer's buttocks.

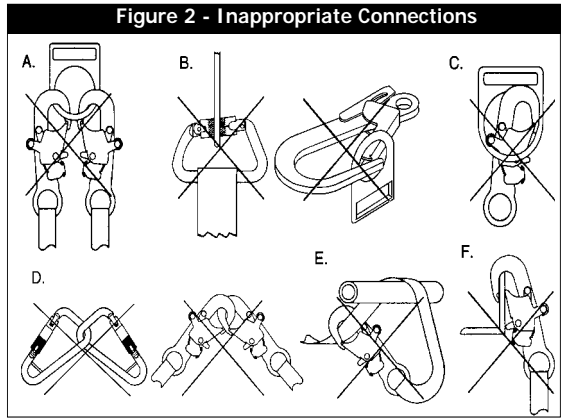

- 3) The harness fits snugly. Proper fit will allow the wearer to perform normal work operations without discomfort.

WARNING: All parachute buckles must be fastened and adjusted properly before any work is performed. Failure to properly fasten and adjust the harness can result in serious or death in the event of a fall from height. If any uncertainty exists regarding the proper fit of a harness consult a qualified person, or contact Protecta.

If it is determined that a larger size is necessary, consult your local Protecta distributor, or contact Protecta directly for information about a distributor in your area.

5.0 VERTICAL LIFELINE SYSTEMS

5.1 VERTICAL LIFELINE APPLICATIONS: Vertical lifeline systems are intended to be used for fall arrest or restraint. These systems are not designed for use as horizontal lifeline systems. Applications include: Inspection work, construction, demolition, maintenance, oil production, confined space rescue, window washing.

5.2 VERTICAL LIFELINE REQUIREMENTS:

The anchorage strength required is dependent upon the application:

- A. FALL ARREST:** Anchorages used for personal fall arrest systems must be capable of sustaining static loads in the directions permitted by the personal fall arrest system of at least: 3,600 lbs. with certification of a qualified person; or 5,000 lbs. without certification. See ANSI Z359.1 for certification definition. When more than one personal fall arrest system is attached to an anchorage, the strengths stated above must be met at each anchorage location independently.
From OSHA 1926.500 and 1910.66: Anchorages used for attachment of personal fall arrest systems shall be independent of any anchorage being used to support or suspend platforms, and capable of supporting at least 5,000 lbs. per user attached, or be designed, installed, and used as part of a complete PFAS which maintains a safety factor of at least two, and is under the supervision of a qualified person.
- B. RESTRAINT:** The restraint system must be attached to an anchorage capable of sustaining static loads in the directions permitted by the restraint system of at least 3,000 lbs. When more than restraint system is attached to an anchorage, the strengths stated above must be met at each anchorage location independently.

5.3 LIMITATIONS:

- A. CAPACITY:** This equipment is designed for use by persons with a combined weight (person, clothing, tools, etc.) of no more than 310 lbs. Only one personal protective system may be connected to an anchor at any time.
- B. FREE FALL:** Personal Fall Arrest Systems (PFAS) must be rigged in such a way as to limit the free fall to a maximum of 6 feet (reference ANSI Z359.1).
- C. FALL CLEARANCE:** Make certain that enough clearance exists in your fall path to prevent striking an object. The amount of clearance needed is dependent upon the type of connecting subsystem used and the anchorage location. See section 10 for lifeline elongation factor when determining fall clearance.
- D. CORROSION:** Use near sea water or other corrosive environments may require more frequent inspections or servicing (replacement) to assure corrosion damage is not affecting the performance of the product.

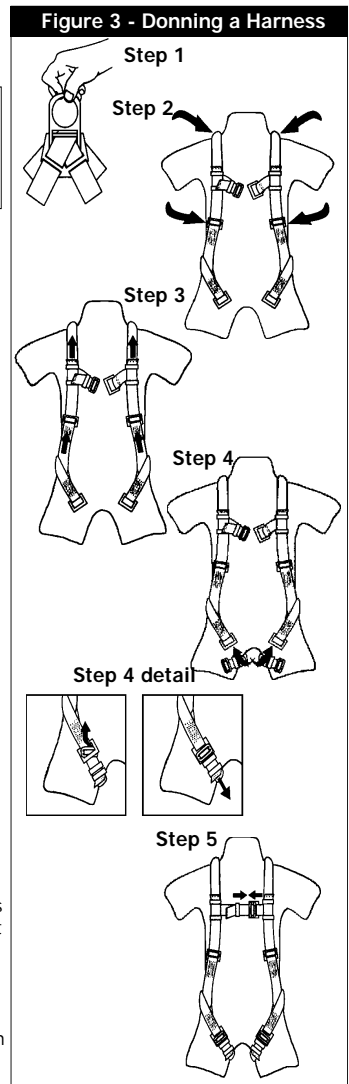

- E. **CHEMICAL HAZARDS:** Solutions containing acids, alkali, or other caustic chemicals, especially at elevated temperatures, may cause damage to this equipment. Consult PROTECTA if doubt exists concerning installing this equipment where chemical hazards are present.
- F. **ENVIRONMENTAL HAZARDS:** Use of this equipment in areas where environmental hazards exist may require additional precautions to reduce the possibility of injury to the user or damage to the equipment. Hazards may include, but are not limited to: high heat, caustic chemicals, corrosive environments, high voltage power lines, explosive or toxic gases, moving machinery, or sharp edges.
- G. **SWING FALLS:** See Figure 4. Swing falls occur when the anchorage point is not directly above the point where a fall occurs. The force of striking an object in a swing fall may cause serious injury. Minimize swing falls by working as directly below the anchorage point as possible. Do not permit a swing fall if injury could occur.
- H. **FREE FALL:** Never work above your anchorage point. Position the rope grab as far up the lifeline as possible to limit your free fall distance to 6 feet.
- I. **FALL CLEARANCE:** There must be sufficient clearance in your fall path to prevent striking an object or the lower level in the event of a fall. The amount of clearance required is dependent upon the application.

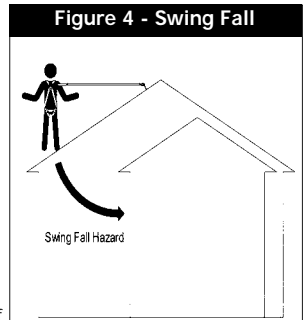

5.4 **CONNECTING TO A VERTICAL LIFELINE:** Use the self locking snap hook that is attached to the vertical lifeline to connect to the D-ring of the roof anchor. Ensure that the snap hook is fully engaged and that the gate closes completely and locks. Do not tie a knot in the lifeline. See Figure 5. The connection must support 5,000 lbs.

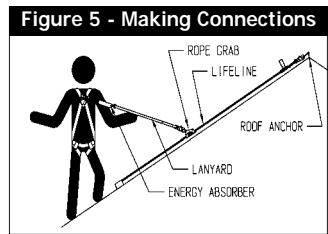

5.5 **LIFELINE COUNTER WEIGHTS:** Tension the lifeline to assure smooth motion of the rope grab on the lifeline. To tension the lifeline: suspend as much as possible of the full length of the lifeline below the rope grab (12 feet minimum required); or secure the end of the lifeline at working or ground level; or use a six to ten pound counterweight. The method of tensioning used should be determined by the job site conditions.

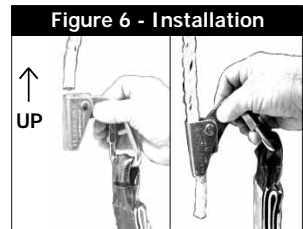

5.6 **1/2 IN. ROPE GRAB**

A. **ATTACHING THE 1/2 in. ROPE GRAB TO THE LIFELINE:**
See Figure 6.

- Step 1. Ensure the rope grab is correctly positioned relative to the lifeline. The "up" arrow on the sleeve must be pointing to the anchorage.
- Step 2. Pivot the handle to its full upright position. This will draw back the rope shoe to allow insertion of the lifeline into the housing.
- Step 3. Hold the rope grab upright and feed the lifeline through the rope grab from the top down.
- Step 4. Check the locking action by lifting up the handle and releasing. The rope grab must lock onto the lifeline. If the rope grab does not securely lock onto the lifeline, repeat steps 1 through 3. Do not use if the rope grab will not operate correctly.

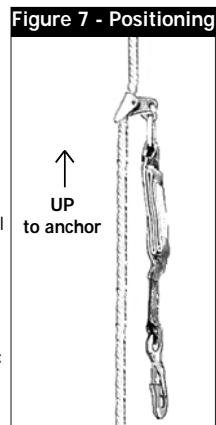

WARNING: Lifelines used with this rope grab must meet the size, construction, material properties, and specifications stated above.

B. **USING AND POSITIONING THE 1/2 IN. ROPE GRAB ON THE LIFELINE:**
See Figure 7.

BEFORE EACH USE

Inspect all personal fall arrest equipment as specified in section 8.

This rope grab is designed to remain in place on the lifeline. To reposition the rope grab on the lifeline, follow these steps:

- Step 1.** To ascend, climb up normally. The rope grab will follow the climber. When working, position the rope grab at or above your back D-ring to minimize free fall distance.
- Step 2.** To descend, climb down smoothly in a normal position. Allow the rope grab to "lead" the climber down. If the rope grab locks, move upward slightly to release the rope grab and continue to descend.
- Step 3.** To check the locking action of the rope grab, lift up the handle and release. The rope grab must lock onto the rope. If the rope grab does not operate correctly, repeat attachment steps listed in section 5.6.

WARNING: Rope grab attachment and positioning procedures must be followed. Improper attachment may cause the rope grab to slip or unlock from the lifeline, which may result in serious injury or death.

WARNING: Ensure the design of your work site and your working location will allow the rope grab to remain locked on the lifeline when a fall occurs. When a fall occurs, the lanyard must pull the handle on the rope grab down to lock the rope grab onto the lifeline.

WARNING: The rope grab handle must not be prevented from locking onto the lifeline by interference from objects, or be held open by hand when in use. Failure to heed this warning may result in serious injury or death.

5.7 5/8 IN. ROPE GRAB

A. ATTACHING THE 5/8 in. ROPE GRAB TO THE LIFELINE:

- Step 1.** Position the rope grab so that the connecting ring is pointed downward as in Figure 8. The "up" arrow stamped on the rope grab body must be pointing to the anchorage.
- Step 2.** Pivot the connecting ring and locking lever upward to its full upright position. This will draw back the brake shoe to allow insertion of the lifeline into the housing.
- Step 3.** Hold the rope grab upright and feed the lifeline through the rope grab from the top down.
- Step 4.** Release the locking lever and check the locking action by pulling the rope upward. The rope grab must lock onto the lifeline. If the rope grab does not securely lock onto the lifeline, repeat steps 1 through 3. Do not use if the rope grab will not operate correctly.

WARNING: Lifelines used with this rope grab must meet the size, construction, material properties, and specifications stated above.

B. USING AND POSITIONING THE 5/8 IN. ROPE GRAB ON THE LIFELINE:

BEFORE EACH USE

Inspect all personal fall arrest equipment as specified in section 8.

This rope grab is designed to remain in place on the lifeline. To reposition the rope grab on the lifeline, follow these steps:

- Step 1.** To ascend, hold the rope below the rope grab and pull the rope grab up the rope. The teeth in the brake shoe are angled to allow the rope grab to be pulled up the rope. When working, position the rope grab at or above your back D-ring to minimize free fall distance.
- Step 2.** To descend, pull up on the connecting ring to open the locking lever and release the rope from the brake shoe. Pull the rope

Figure 8 - 5/8 in. Rope Grab

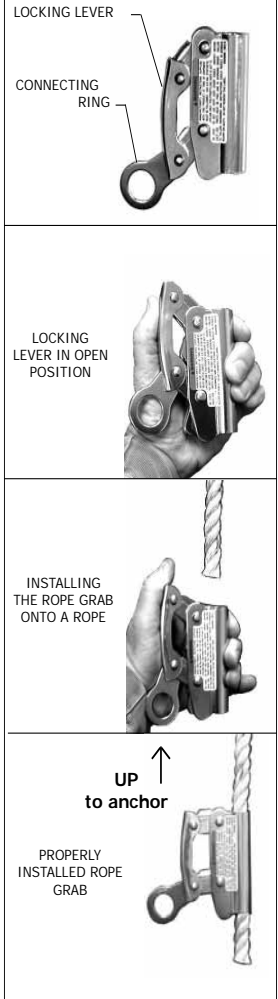

upward through the rope grab while the locking lever is in the up position. When your new location is reached, release the locking lever and the rope grab will lock onto the rope.

- Step 3.** Check the locking action of the rope grab. The rope grab must lock onto the rope. If the rope grab does not operate correctly, repeat attachment steps listed in section 5.6.

WARNING: Rope grab attachment and positioning procedures must be followed. Improper attachment may cause the rope grab to slip or unlock from the lifeline, which may result in serious injury or death.

WARNING: The rope grab handle must not be prevented from locking onto the lifeline by interference from objects, or be held open by hand when in use. Failure to heed this warning may result in serious injury or death.

- 5.8 LANYARD:** Only the energy absorber supplied permanently attached to the rope grab may be used. This energy absorber limits fall arrest forces to 900 lbs. and length is limited to 1.4 feet. If the energy absorber is damaged, it must be replaced using an identical model.

- 5.9 BODY SUPPORT:** For fall arrest applications, a full body harness must be used. The integrated energy absorber must be attached to the dorsal D-ring on the harness.

5.10 ROOF ANCHOR INSTALLATION

PURPOSE: PROTECTA's roof anchor is designed to be used as a temporarily installed (not for permanent installation) anchorage connector on wood frame structures. See Figure 9. This anchorage connector may be used as part of a personal fall arrest or restraint system. Do not attach a lifeline between two or more roof anchors (i.e. horizontal lifeline system). Do not hang, lift or support tools or equipment from this roof anchor or attach guylines for antennas, phone lines, etc.

Figure 9 - Roof Anchor

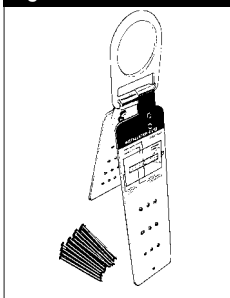

1. SITE PLAN : Before starting the roof construction, a plan should be established as to where the roof anchors will be installed and when during the construction process they may be used. The following are guidelines on locating roof anchors :

- The roof anchor should be located at the roof peak (when possible) and at least 6 feet from any exposed edge. On very small roof areas, locate the anchor as far from the roof edge as possible.
- Do not install roof anchors on unsupported roof structures such as eaves or gable overhangs.
- Do not install roof anchors on fascia boards.
- Roof anchors should be installed at 8 foot spacing along the roof peak.
- Hip roofs require a roof anchor on each hip face.
- On long low pitched roofs, multiple roof anchors should be installed along gable ends (6 feet from edge) to reduce swing fall hazards.

Figure 10 shows typical roof anchor locations for various roof configurations.

Figure 10 - Roof Anchor Locations

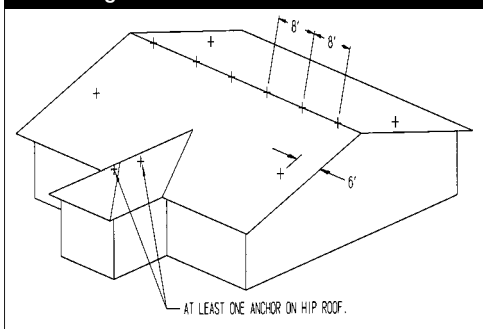

2. ANCHORAGE STRENGTH: The anchorage strength required is dependent on the application. Following are anchorage strength requirements for specific applications:

- A. FALL ARREST:** The structure to which the anchorage connector is attached must sustain static loads applied in the directions permitted by the fall arrest system of at least: 3,600 lbs. with certification of a qualified person, or 5,000 lbs. without certification. See ANSI Z359.1 for certification definition. When more than one personal fall arrest system is attached to an anchorage, the strengths stated above must be multiplied by the number of personal fall arrest systems attached to the anchorage. When more than one anchor is installed to a structure, the strengths given in (A) or (B) above must be met at each roof anchors installation point independently. **EXAMPLE:** If two roof anchors are installed onto a roof structure, each anchor location must be independently capable of supporting 5,000 lbs. (or 3,600 lbs. with certification).

From OSHA 1926.500 and 1910.66: Anchorages used for attachment of a personal fall arrest system shall be independent of any anchorage being used to support or suspend platforms, and must support at least 5,000 lbs. per user attached; or be designed, installed, and used as part of a complete personal fall arrest system which maintains a safety factor of at least two, and is supervised by a qualified person.

- B. RESTRAINT:** The structure to which the anchorage connector is attached must sustain static loads applied in the directions permitted by the restraint system of at least 3,000 lbs. When more than one restraint system is attached to an anchorage, the strengths stated above must be multiplied by the number of restraint systems attached to the anchorage.
- C. WORK POSITIONING:** The structure to which the anchorage connector is attached must sustain static loads applied in the directions permitted by the work positioning system of at least 3,000 lbs., or twice the potential impact load, whichever is greater. When more than one work positioning system is attached to an anchorage, the strengths stated above must be multiplied by the number of work positioning systems attached to the anchorage.
- D. PERSONNEL RIDING:** The structure to which the anchorage connector is attached must sustain static loads applied in the directions permitted by the personnel riding system of at least 2,500 lbs. When more than one personnel riding system is attached to an anchorage, the strengths stated above must be multiplied by the number of personnel riding systems attached to the anchorage.
- E. RESCUE:** The structure to which the anchorage connector is attached must sustain static loads applied in the directions permitted by the rescue system of at least 2,500 lbs. When more than one rescue system is attached to an anchorage, the strengths stated above must be multiplied by the number of rescue systems attached to the anchorage.

3. LIMITATIONS: The following limitations apply to the use of Roof Anchors

- A. CAPACITY:** This equipment is designed for use by persons with a combined weight (person, clothing, tools, etc.) of no more than 310 lbs. Only one personal protective system may be connected to an anchor at any time.
- B. FREE FALL:** Personal Fall Arrest Systems (PFAS) must be rigged in such a way as to limit the free fall to a maximum of 6 feet (reference ANSI Z359.1). See associated connecting subsystem manufacturer's instructions for further information.
- C. FALL CLEARANCE:** Make certain that enough clearance exists in your fall path to prevent striking an object. The amount of clearance needed is dependent upon the type of connecting subsystem used (energy absorbing lanyard, self retracting lifeline, etc.), and the anchorage location.
- D. CHEMICAL HAZARDS:** Solutions containing acids, alkali, or other caustic chemicals, especially at elevated temperatures, may cause damage to this equipment. Consult PROTECTA if doubt exists concerning installing this equipment where chemical hazards are present.
- E. ELECTRICAL HAZARDS:** Do not install anchors where they or the user may come into contact with electrical power lines.
- F. ENVIRONMENTAL HAZARDS:** Use of this equipment in areas where environmental hazards exist may require additional precautions to reduce the possibility of injury to the user or damage to the equipment. Hazards may include, but are not limited to: high heat, caustic chemicals, corrosive environments, high voltage power lines, explosive or toxic gases, moving machinery, or sharp edges.
- G. SWING FALLS:** Swing falls occur when the anchorage point is not directly overhead. The force of striking an object in a swing fall may cause serious injury or death. Minimize swing falls by working as directly below the anchorage point as possible. Do not permit a swing fall if injury could occur. Swing falls will significantly increase the clearance required when a self retracting lifeline or other variable length connecting subsystem is used. If a swing fall situation exists in your application, contact PROTECTA before proceeding.

5.11 ROOF FRAMING: Roof framing members to which the roof anchors are attached must be in good condition. Members must be free of splits, cracks, large knots, or other defects that may weaken the member. Do not attach the roof anchor to rotted or deteriorated wood.

5.12 ATTACHING THE ROOF ANCHOR: Spread the anchor base legs apart to match the surface it will be mounted on, either a roof peak or a flat surface. Position the anchor on the roof such that the 12 nailing holes along the center of the legs are over a roof (framing) member (see Figure 11). Push down to minimize any gap between the anchor and sheathing, then drive nails through the preformed holes in the anchor legs.

Install all 20 nails. Use only 16d nails to install the anchor (6 per leg into the rafters and sheathing, 4 per leg into the sheathing). Install all 20 nails.

WARNING: The AJ730A roof anchor must be positioned on top of previously secured roof sheathing (do not attach directly to rafter or truss member). All 20 nails must be installed. If the roof anchor is not installed properly, it will not hold the rated loads and serious injury or death could occur.

WARNING: Use only 16d nails which have a complete head. Do not use nails from nail guns. Never attach the roof anchor with the legs still together (legs must be spread apart).

Figure 11 - Roof Anchor Installation

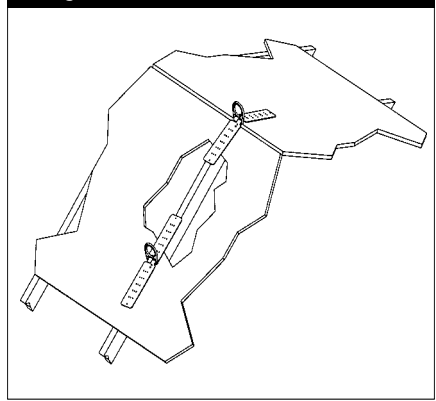

5.13 CONCRETE ANCHOR INSTALLATION

1. CONCRETE ANCHOR APPLICATIONS:

The AJ720A Concrete Anchor is designed to be used as a permanently installed anchorage connector on concrete surfaces. It is designed to be used only as the anchorage connector for a single personal fall arrest system. Concrete anchors may be used for temporary horizontal lifelines that limit loading to less than 2500 lbs. Do not hang, lift, or support tools or equipment from the attached anchor.

2. CONCRETE ANCHOR REQUIREMENTS AND LIMITATIONS:

The anchorage strength required is dependent on the application. Following are anchorage strength requirements for specific applications:

- A. FALL ARREST:** The structure to which the anchorage connector is attached must sustain static loads applied in the directions permitted by the fall arrest system of at least: 3,600 lbs. with certification of a qualified person, or 5,000 lbs. without certification. See ANSI Z359.1 for certification definition. When more than one personal fall arrest system is attached to an anchorage, the strengths stated above must be multiplied by the number of personal fall arrest systems attached to the anchorage. When more than one anchor is installed to a structure, the strengths given in (A) or (B) above must be met at each roof anchors installation point independently. **EXAMPLE:** If two roof anchors are installed onto a roof structure, each anchor location must be independently capable of supporting 5,000 lbs. (or 3,600 lbs. with certification).

From OSHA 1926.500 and 1910.66: Anchorages used for attachment of a personal fall arrest system shall be independent of any anchorage being used to support or suspend platforms, and must support at least 5,000 lbs. per user attached; or be designed, installed, and used as part of a complete personal fall arrest system which maintains a safety factor of at least two, and is supervised by a qualified person.

- B. RESTRAINT:** The structure to which the anchorage connector is attached must sustain static loads applied in the directions permitted by the restraint system of at least 3,000 lbs. When more than one restraint system is attached to an anchorage, the strengths stated above must be multiplied by the number of restraint systems attached to the anchorage.
- C. WORK POSITIONING:** The structure to which the anchorage connector is attached must sustain static loads applied in the directions permitted by the work positioning system of at least 3,000 lbs., or twice the potential impact load, whichever is greater. When more than one work positioning system is attached to an anchorage, the strengths stated above must be multiplied by the number of work positioning systems attached to the anchorage.
- D. PERSONNEL RIDING:** The structure to which the anchorage connector is attached must sustain static loads applied in the directions permitted by the personnel riding system of at least 2,500 lbs. When more than one personnel riding system is attached to an anchorage, the strengths stated above must be multiplied by the number of personnel riding systems attached to the anchorage.
- E. RESCUE:** The structure to which the anchorage connector is attached must sustain static loads applied in the directions permitted by the rescue system of at least 2,500 lbs. When more than one rescue system is attached to an anchorage, the strengths stated above must be multiplied by the number of rescue systems attached to the anchorage.

3. LIMITATIONS: The following limitations apply to the use of Concrete Anchors

- A. CAPACITY:** This equipment is designed for use by persons with a combined weight (person, clothing, tools, etc.) of no more than 310 lbs. Only one personal protective system may be connected to an anchor at any time.
- B. FREE FALL:** Personal Fall Arrest Systems (PFAS) must be rigged in such a way as to limit the free fall to a maximum of 6 feet (reference ANSI Z359.1). See associated connecting subsystem manufacturer's instructions for further information.
- C. FALL CLEARANCE:** Make certain that enough clearance exists in your fall path to prevent striking an object. The amount of clearance needed is dependent upon the type of connecting subsystem used (energy absorbing lanyard, self retracting lifeline, etc.), and the anchorage location. Refer to manufacturer's instructions of the connecting subsystem or component for more information on fall clearance.
- D. CHEMICAL HAZARDS:** Solutions containing acids, alkali, or other caustic chemicals, especially at elevated temperatures, may cause damage to this equipment. Consult PROTECTA if doubt exists concerning installing this equipment where chemical hazards are present.
- E. ELECTRICAL HAZARDS:** Do not install anchors where they or the user may come into contact with electrical power lines.
- F. ENVIRONMENTAL HAZARDS:** Use of this equipment in areas where environmental hazards exist may require additional precautions to reduce the possibility of injury to the user or damage to the equipment. Hazards may include, but are not limited to: high heat, caustic chemicals, corrosive environments, high voltage power lines, explosive or toxic gases, moving machinery, or sharp edges.
- G. SWING FALLS:** Swing falls occur when the anchorage point is not directly overhead. The force of striking an object in a swing fall may cause serious injury or death. Minimize swing falls by working as directly below the anchorage point as possible. Do not permit a swing fall if injury could occur. Swing falls will significantly increase the clearance required when a self retracting lifeline or other variable length connecting subsystem is used. If a swing fall situation exists in your application, contact PROTECTA before proceeding.

5.14 ATTACHING THE ANCHOR : Anchor installation requires that holes be drilled into the concrete surface and the included anchor bolts inserted and affixed. These instructions must be followed precisely in order for the system to perform as designed. Failure to follow these instructions could cause serious or fatal injury. Only after installation of the anchorage bolts and plate is complete (including drying time, any pull-testing, etc.) should a personal fall arrest system be attached.

5.15 ANCHOR LOCATION: Anchor plates (AJ720A) must be located at structurally sound points. Holes for the anchor must be at least 4 inches from any free edge. When more than one AJ720A Concrete Anchor is mounted on an anchorage, they must be separated by at least 10 inches. See Figure 12.

NOTE: It is recommended that the holes be drilled and the bolts installed with the anchor plate in place, using the plate as a guide to keep the drill from wandering.

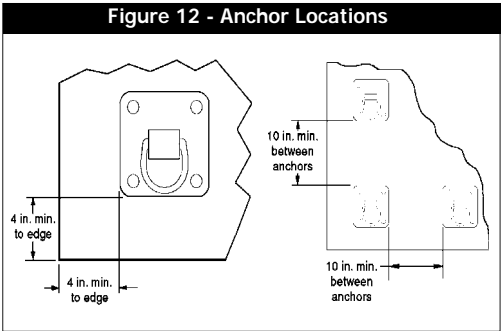

5.16 INSTALLING THE ANCHOR: Anchor installation requires that holes be drilled into the concrete surface and the included anchor bolts inserted and affixed: See Figure 13.

STEP 1. Using a 1/2 in. carbide drill bit, drill each hole a minimum of 3 3/4 in. deep. Clean out the holes with a blow-out bulb or compressed air.

STEP 2. Assemble the washer and nut onto the bolt. Screw the nut onto the bolt until it is flush with the top of the bolt to protect the threads. Place the bolt through anchor plate and into the hole. Drive the bolt into the hole until the washer is pressed against the surface of the anchor plate.

STEP 3. Expand the anchor bolt by tightening the bolt to the installation torque of 55 ft. lbs. The minimum embedment in concrete is 2¼ in.

WARNING: Always wear safety glasses and other necessary protective devices or apparel when installing or working with anchor bolts.

CAUTION: Not recommended for use in lightweight masonry such as block or brick.

CAUTION: Use of carbide drill bits manufactured within ANSI B94.12-77 drill bit diameter requirements is recommended for installation of this anchor bolt. Use of core drills is not recommended to drill holes for use with this anchor.

Figure 13 - Installing Anchor Bolts

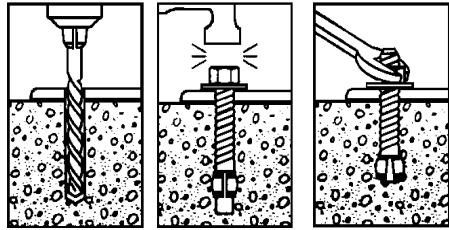

1. Drill and clean hole.

2. Drive assembled bolt into hole.

3. Tighten to appropriate torque.

CAUTION: Not recommended for use in new concrete which has not had sufficient time to cure.

5.17 WEB AND WIRE ROPE SLING INSTALLATION:

1. WIRE ROPE AND WEB SLING ANCHOR APPLICATIONS: The wire rope sling and web anchor strap is designed to be used as an anchorage connector for a personal fall arrest, restraint, work positioning, suspension, or rescue system. Wire rope slings and web anchor straps may be used as anchorage connectors for a horizontal lifeline if the system is designed, installed and used under the supervision of a qualified person. Do not hang, lift, or support tools or equipment from this equipment.

A. STRUCTURE: The structure to which the anchorage connector is attached must be free of corrosion, cracks, deformities, or other defects that may weaken the structure. Do not attach an anchorage connector to a vertical structure unless a means of restraining the connector from sliding down the structure is present. If the anchorage connector were to slide down the structure in a fall arrest situation, serious injury to the user is possible.

2. ANCHORAGE REQUIREMENTS:

The anchorage strength required is dependent on the application. Following are anchorage strength requirements for specific applications:

A. FALL ARREST: The structure to which the anchorage connector is attached must sustain static loads applied in the directions permitted by the fall arrest system of at least: 3,600 lbs. with certification of a qualified person, or 5,000 lbs. without certification. See ANSI Z359.1 for certification definition. When more than one personal fall arrest system is attached to an anchorage, the strengths stated above must be multiplied by the number of personal fall arrest systems attached to the anchorage. When more than one anchor is installed to a structure, the strengths given in (A) or (B) above must be met at each roof anchors installation point independently. **EXAMPLE:** If two roof anchors are installed onto a roof structure, each anchor location must be independently capable of supporting 5,000 lbs. (or 3,600 lbs. with certification).

From OSHA 1926.500 and 1910.66: Anchorages used for attachment of a personal fall arrest system shall be independent of any anchorage being used to support or suspend platforms, and must support at least 5,000 lbs. per user attached; or be designed, installed, and used as part of a complete personal fall arrest system which maintains a safety factor of at least two, and is supervised by a qualified person.

B. RESTRAINT: The structure to which the anchorage connector is attached must sustain static loads applied in the directions permitted by the restraint system of at least 3,000 lbs. When more than one restraint system is attached to an anchorage, the strengths stated above must be multiplied by the number of restraint systems attached to the anchorage.

C. WORK POSITIONING: The structure to which the anchorage connector is attached must sustain static loads applied in the directions permitted by the work positioning system of at least 3,000 lbs., or twice the potential impact load, whichever is greater. When more than one work positioning system is attached to an anchorage, the strengths stated above must be multiplied by the number of work positioning systems attached to the anchorage.

- D. **PERSONNEL RIDING:** The structure to which the anchorage connector is attached must sustain static loads applied in the directions permitted by the personnel riding system of at least 2,500 lbs. When more than one personnel riding system is attached to an anchorage, the strengths stated above must be multiplied by the number of personnel riding systems attached to the anchorage.
- E. **RESCUE:** The structure to which the anchorage connector is attached must sustain static loads applied in the directions permitted by the rescue system of at least 2,500 lbs. When more than one rescue system is attached to an anchorage, the strengths stated above must be multiplied by the number of rescue systems attached to the anchorage.

3. LIMITATIONS:

- A. **CAPACITY:** This equipment is designed for use by persons with a combined weight (person, clothing, tools, etc.) of no more than 310 lbs. Only one personal protective system may be connected to an anchor at any time.
- B. **FREE FALL:** Personal Fall Arrest Systems (PFAS) must be rigged in such a way as to limit the free fall to a maximum of 6 feet (reference ANSI Z359.1). See associated connecting subsystem manufacturer's instructions for further information.
- C. **FALL CLEARANCE:** Make certain that enough clearance exists in your fall path to prevent striking an object. The amount of clearance needed is dependent upon the type of connecting subsystem used (energy absorbing lanyard, self retracting lifeline, etc.), and the anchorage location.
- D. **CHEMICAL HAZARDS:** Solutions containing acids, alkali, or other caustic chemicals, especially at elevated temperatures, may cause damage to this equipment. Consult PROTECTA if doubt exists concerning installing this equipment where chemical hazards are present.
- E. **ELECTRICAL HAZARDS:** Do not install anchors where they or the user may come into contact with electrical power lines.
- F. **ENVIRONMENTAL HAZARDS:** Use of this equipment in areas where environmental hazards exist may require additional precautions to reduce the possibility of injury to the user or damage to the equipment. Hazards may include, but are not limited to: high heat, caustic chemicals, corrosive environments, high voltage power lines, explosive or toxic gases, moving machinery, or sharp edges.
- G. **SWING FALLS:** Swing falls occur when the anchorage point is not directly overhead. The force of striking an object in a swing fall may cause serious injury or death. Minimize swing falls by working as directly below the anchorage point as possible. Do not permit a swing fall if injury could occur. Swing falls will significantly increase the clearance required when a self retracting lifeline or other variable length connecting subsystem is used. If a swing fall situation exists in your application, contact PROTECTA before proceeding.

5.18 INSTALLING THE WEB STRAP CHOKER ANCHOR SLING: Place the web strap over the anchorage with the labels facing out. Both ends of the web strap must be hanging below the anchorage as shown in Figure 14. With the web strap positioned on the anchorage, pass the D-ring through the web loop. Slide the web loop up to the anchorage, over the webbing attached to the small D-ring. Pull the small D-ring down to take up slack that was made by moving the large D-ring up. The web strap should be tightly wrapped around the anchorage with the small D-ring hanging free. You may shorten the distance that the attachment ring hangs from the anchorage by wrapping the webbing around the anchorage several times. Pass the D-ring through the web loop on each pass.

5.19 INSTALLING THE WIRE ROPE SLING: Place the wire rope sling over the anchorage. The D-rings must be hanging below the anchorage as shown in Figure 15. With the sling positioned on the anchorage, pass the small attachment ring through the large ring. Slide the large ring up to the anchorage, over the wire rope attached to the small attachment ring. Pull the small attachment ring down to take up slack that was made by moving the large ring up. The wire rope sling should be tightly wrapped around the anchorage with the small attachment ring hanging free. You may shorten the distance that the attachment ring hangs from the anchorage by wrapping the adapter around the anchorage several times. Pass the small attachment ring through the large ring on each pass. When the installation is complete, any connections to the tie-off adapter must be made to the small attachment ring.

Figure 14 - Webstrap Anchor Sling installation

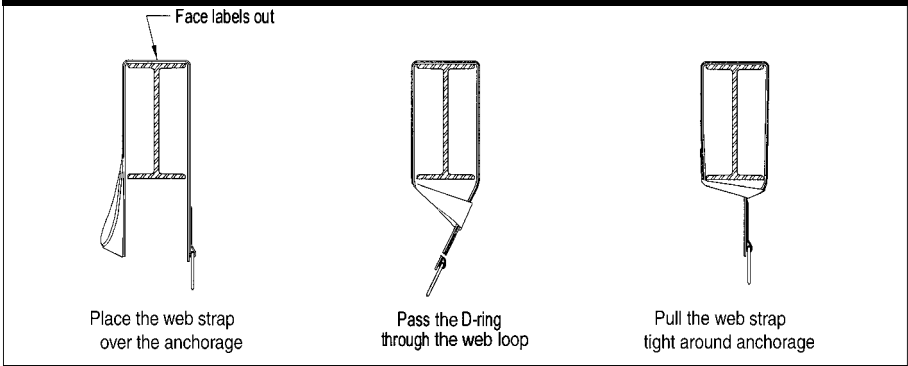
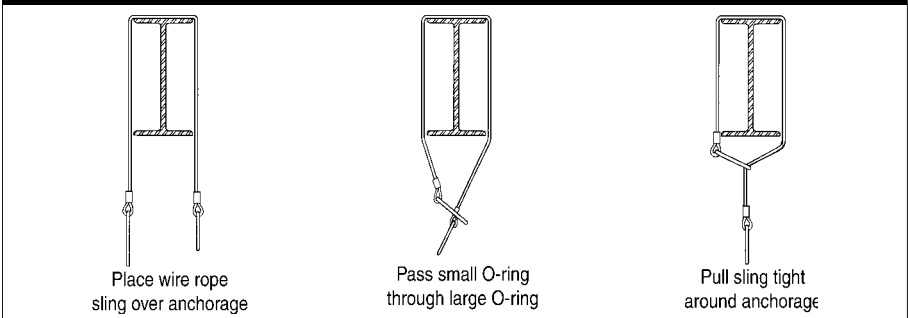

Figure 15 - Wire Rope Anchor Sling Installation



6.0 SELF RETRACTING LIFELINE SYSTEMS

6.1 SRL APPLICATION: PROTECTA self retracting lifeline (SRL) systems are intended to be used in situations where worker mobility and fall protection is needed (inspection work, general construction, maintenance work, oil production, confined space work, etc.) See Figure 16.

6.2 MAKING CONNECTIONS: Attach the self retracting lifeline (SRL) to the D-ring of the anchorage connector using the supplied carabiner. Make sure the carabiner closes completely and locks.

- A. OPERATION:** Inspect the SRL as described in section 8.0. Connect the SRL to a suitable anchorage or anchorage connector as described above. Connect the self locking snap hook or self locking/ self closing carabiner on the end of the lifeline to the fall arrest (dorsal D-ring). Ensure connections are compatible in size, shape, and strength. Ensure the snap hook is securely closed and locked.

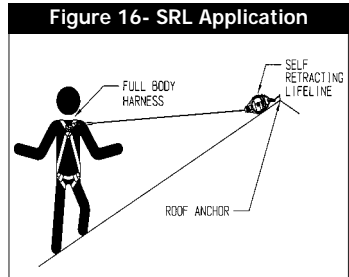

BEFORE EACH USE inspect all personal fall arrest equipment as specified in section 8.0.

- B. USE:** When attached to the SRL, the worker is free to move about within recommended working areas at normal speeds. See Figure 16. The lifeline should extend smoothly and retract without hesitation. While using, always ensure that there is constant tension on the lifeline. Slack in the wire rope could result in an increase in fall distance. If slack line condition is created in normal use the unit should be returned to PROTECTA for service. Should a fall occur, the SRL will lock and arrest the fall. Upon rescue, remove the SRL from use. Inspect as described in section 8.0. When working with the SRL, allow the lifeline to recoil back into the device under control. A short tag line may be required to extend or retract the lifeline during connection and disconnection. Allowing the lifeline to be fully extended for long periods of time may cause premature weakening of the retraction spring.

6.3 SRL LIMITATIONS

- A. **ELECTRICAL HAZARDS:** For web and synthetic rope models, there is a possibility of moisture absorption by the lifeline. Moisture absorbed by the lifeline may provide a path for electrical current to flow, resulting in electrical shock. Use caution when the lifeline may contact high voltage power lines. For wire rope models, there is a possibility of electric current flowing through the lifeline. Use caution where the lifeline may contact high voltage power lines.
- B. **CAPACITY:** The SRL is for use by persons with a combined weight (person, clothing, tools, etc.) of 75 lbs. minimum and 310 lbs. maximum. No more than one person can connect to an SRL.
- C. **LOCKING SPEED:** Situations which do not allow for an unobstructed fall path should be avoided. Working in confined or cramped spaces may not allow sufficient speed to cause the SRL to lock in a fall. Working on slowly shifting materials, such as sand or grain, may not allow sufficient speed to cause the SRL to lock. A similar situation may occur on low pitched roofs, where a worker may slide instead of fall. A clear path is required to ensure positive locking of the SRL.
- D. **FALL CLEARANCE:** Make certain that enough clearance exists in your fall path to prevent striking an object. The amount of clearance needed is dependent upon the type of connecting subsystem used (energy absorbing lanyard, self retracting lifeline, etc.), and the anchorage location.
- E. **NORMAL OPERATION:** Normal operation will allow the full length of the lifeline to extend and retract with no hesitation when extending and no slack when retracting as the worker moves at normal speeds. If a fall occurs, a speed sensing brake system will activate, stopping the fall and absorbing much of the energy created. For falls that occur near the end of the lifeline travel, the reserve lifeline system will ensure a reduced impact fall arrest. If a fall has been arrested, the SRL must be taken out of service and inspected. Sudden or quick movements should be avoided during the normal work operation, as this may cause the SRL to lock-up.
- F. **CHEMICAL HAZARDS:** Solutions containing acids, alkali, or other caustic chemicals, especially at elevated temperatures, may cause damage to this equipment. Consult PROTECTA if doubt exists concerning installing this equipment where chemical hazards are present.
- G. **ENVIRONMENTAL HAZARDS:** Use of this equipment in areas where environmental hazards exist may require additional precautions to reduce the possibility of injury to the user or damage to the equipment. Hazards may include, but are not limited to: high heat, caustic chemicals, corrosive environments, high voltage power lines, explosive or toxic gases, moving machinery, or sharp edges.

7.0 HORIZONTAL LIFELINE SYSTEMS

7.1 **APPLICATIONS:** The PROTECTA Synthetic Rope Horizontal Lifeline System is designed for use as an anchoring means for one or two persons. Use the PROTECTA Horizontal Lifeline System where horizontal mobility and fall protection are required.

7.2 REQUIREMENTS:

- A. **PERSONAL FALL ARREST SYSTEM COMPONENTS:** The PROTECTA horizontal lifeline must be used with PROTECTA approved components and subsystems. Non-approved components may be incompatible, and could affect the safety and reliability of the complete system. Personal fall arrest components used with this system must meet all applicable OSHA and ANSI requirements. A full body harness must be used with this system.
- B. **PERSONAL FALL ARREST SYSTEM CONNECTORS:** Connectors used to attach to the attachment O-ring on the horizontal lifeline (hooks, carabiners, D-rings) must support at least 5,000 lbs. Connectors and attachment elements must be compatible in size, shape, and strength. Non-compatible connectors may unintentionally disengage (roll-out). Do not use non-locking connectors with this system.
- C. **ANCHORAGE CONNECTORS:** Connectors used to attach the horizontal lifeline to end anchors must be compatible with the connection point. The connection must be positive; and, with connecting elements, capable of sustaining a 5,000 lbs. load without failure.
- D. **STRUCTURE LOAD:** Structural anchorage points must be rigid, and capable of supporting at least 3,600 lbs. along the axis of the horizontal lifeline. Anchorages must also support at least 3,600 lbs. applied in all potential directions of fall arrest that are perpendicular to the axis of the horizontal lifeline.

WARNING: Anchorages must be rigid. Large deformations of the anchorage will affect system performance, and may increase the required fall clearance below the system, which could result in serious injury or death.

7.3 LIMITATIONS: The following limits apply to the installation and use of the PROTECTA Horizontal Lifeline System. Other limitations may apply:

IMPORTANT: OSHA regulations state that horizontal lifelines shall be installed and used under the supervision of a qualified person (see the following for definition) as part of a complete personal fall arrest system that maintains a safety factor of at least two.

Qualified Person: An individual with a recognized degree or professional certificate, and extensive knowledge and experience in the subject field, who is capable of design, analysis, evaluation, and specification in the subject work, project, or product. Refer to OSHA 1910.66, 1926.32, and 1926.502.

- A. HORIZONTAL LIFELINE SPAN:** The maximum span distance is 60 feet. The span length must be reduced when clearance is limited. See Figure 17 for clearance information.
- B. ANCHORAGES:** The PROTECTA horizontal lifeline must be installed on anchorages that meet the requirements specified previously.
- C. SYSTEM CAPACITY:** The maximum capacity of the PROTECTA horizontal lifeline is one person. The maximum weight of each person, including tools and clothing, is 310 lbs.
- D. CONNECTING SUBSYSTEM:** The user's connecting subsystem must limit fall arrest forces to 900 lbs. or less.
- E. FREE FALL:** Rig and use the personal fall arrest system such that the maximum potential free fall does not exceed Government regulatory and subsystem manufacturer's requirements.
- F. SWING FALLS:** Swing falls occur when the anchorage point is not directly overhead. The force of striking an object in a swing fall may cause serious injury or death. Minimize swing falls by working as directly below the anchorage point as possible. Do not permit a swing fall if injury could occur. Swing falls will significantly increase the clearance required when a self retracting lifeline or other variable length connecting subsystem is used. If a swing fall situation exists in your application, contact PROTECTA before proceeding.
- G. BODY SUPPORT:** A full body harness must be used with the PROTECTA Horizontal Lifeline System.
- H. CONNECTING SUBSYSTEM:** The connecting subsystem is the portion of the personal fall arrest system that connects the horizontal lifeline subsystem and harness fall arrest attachment element. The connecting subsystem must limit forces applied to the horizontal lifeline to 900 lbs. or less.

7.4 HORIZONTAL LIFELINE INSTALLATION: Figure 17 shows a typical horizontal lifeline (HLL) installation. When using an energy absorbing lanyard to connect to the system, the end anchorages must be located at a height which will limit the free fall to six (6) feet. When using a self retracting lifeline (SRL) to connect to the system, the end anchorages must be located above the user. The SRL, when fully retracted, must be above the harness attachment level.

The horizontal lifeline system should be positioned at a level that will minimize free fall while allowing ease of use. The horizontal lifeline should be positioned near the work location to minimize swing fall hazards. The connecting subsystem length should be kept as short as possible to reduce the potential free fall and required clearance distance. See Figures 17 and 18 for minimum fall clearances required. Both anchorages must be installed at approximately the same elevation, so that the horizontal lifeline system is not sloped more than five (5) degrees.

Figure 17 - Fall Clearance for Energy Absorbing

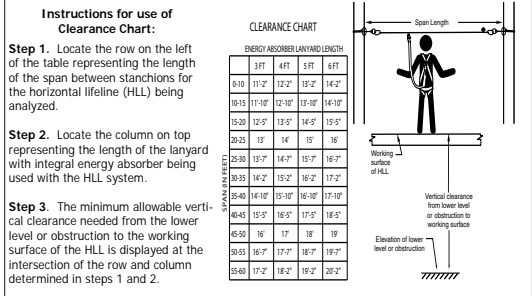

Step 1. Install the anchor sling to the anchor structure at both ends of the planned HLL installation. See section 5.18/5.19.

- Step 2.** Connect the carabiner on the turnbuckle end of the HLL assembly to one of the anchor slings.
- Step 3.** Extend the turnbuckle so that 1/2 inch of threads remain exposed in the turnbuckle body slots.
- Step 4.** Connect the carabiner on the thimble clamp end of the HLL assembly to the other wire rope sling. Loosen the cable clips at the end of the cable assembly and pull the wire rope tight to remove slack. Secure the cable clip 1 1/2 inches from the thimble clamp as shown in Figure 19. At least 8 inches of wire rope must extend out from the free cable clip. Torque cable clips to 45 ft-lbs and thimble clamp nuts to 40 ft-lbs.

Figure 18 - Fall Clearance for Self Retracting Lifelines

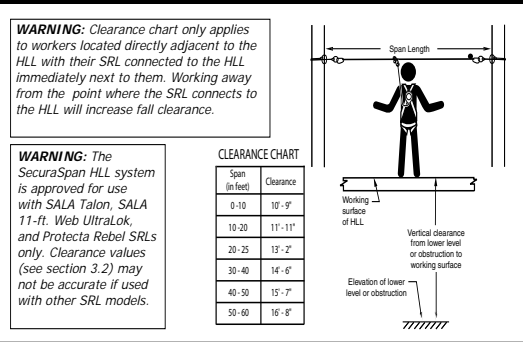
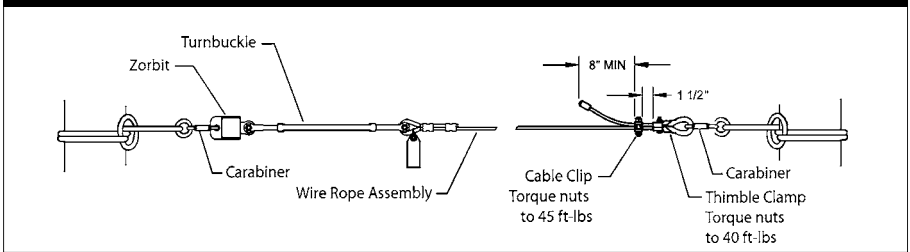

Figure 19 - Horizontal Lifeline Installation



- Step 5.** To pre-load the system, tighten the wire rope by rotating the turnbuckle body. The unrestrained jaw of the turnbuckle must be prevented from turning to prevent twisting of the wire rope. Tension the wire rope until the sag on the system at mid-span is 6 inches or less, with no weight on the wire rope. The turnbuckle will not over tension the wire rope.
- Step 6.** After pre-loading the system, re-torque all cable clips to values specified previously.

7.5 USE OF THE HLL SYSTEM:

- A. PERSONAL FALL ARREST SYSTEM COMPONENTS:** Inspect and don the full body harness according to section 7. Attach the energy absorbing pack end of the lanyard to the dorsal connection on the harness.
- B. CONNECTING TO THE HLL SYSTEM:** Approach the work area using the appropriate access equipment. Connect snaphook of the free end of the lanyard to an O-ring on the HLL. Make sure the snaphook closes completely and locks.
- C. WALKING ALONG THE SYSTEM:** Once attached to the HLL System, the lanyard will follow the user along the lifeline.

WARNING: Movement along the horizontal lifeline must be done manually by the user of the system. Never allow moving stock (such as railcars) to move the user along the lifeline. This could cause serious injury or death.

- D. HAZARDOUS SITUATIONS:** Do not take unnecessary risks, such as jumping or reaching too far from the edge of the working surface. Do not allow the connecting subsystem to pass under arms or between feet. To avoid inadequate fall clearance, do not climb above the HLL. To avoid swing fall hazards, do not work too far from either side of the HLL.

8.0 INSPECTION

8.1 BEFORE EACH USE

Inspect all personal fall arrest equipment as specified in the following sections.

8.2 FORMAL INSPECTION

A formal inspection of the anchorage connector must be performed at least annually by a competent person other than the user. The frequency of formal inspections should be based on conditions of use or exposure. Record the inspection results in the inspection and maintenance log at the back of this manual.

IMPORTANT: *If this equipment has been subjected to forces resulting from the arrest of a fall, it must be immediately removed from service and destroyed or returned to PROTECTA for possible repair.*

IMPORTANT: *Extreme working conditions (harsh environments, prolonged use, etc.) may require increasing the frequency of inspections.*

IMPORTANT: *Only PROTECTA or parties authorized in writing may make repairs to this equipment*

8.3 ROPE GRAB AND ENERGY ABSORBER INSPECTION

A. ROPE GRAB:

- Step 1:** Inspect the handle and rope shoe for bends, cracks, and deformities. All fasteners must be securely attached. Operation of the handle and rope shoe must be free and smooth. The spring must be secure and of sufficient strength to pull the handle down.
- Step 2:** Inspect the rope grab's body for wear on the inside where the rope passes through it.

B. ENERGY ABSORBER:

- Step 1:** Inspect energy absorber component hardware (snap hook and carabiner). These items must not be damaged, broken, distorted, or have any sharp edges, burrs, cracks, worn parts, or corrosion. Ensure the connecting hooks work properly. Hook gates must move freely and lock upon closing.
- Step 2:** Inspect the energy absorber component per the following as applicable:
WEBBING AND STITCHING: Webbing material must be free of frayed, cut, or broken fibers. Check for tears, abrasions, mold, burns, or discoloration, etc. The webbing must be free of excessive soiling, heavy paint buildup, and rust staining. Check for chemical or heat damage indicated by brown, discolored, or brittle areas. Check for ultraviolet damage indicated by discoloration and the presence of splinters or slivers on the webbing surface. All of the above factors are known to reduce webbing strength. Inspect stitching for pulled or cut stitches. Broken stitches may be an indication the energy absorber component has been impact loaded and must be removed from service.
- Step 3. ENERGY ABSORBING COMPONENT:** Inspect the energy absorber to determine if it has been activated. Ensure the energy absorber cover is secure and not torn or damaged. When activated the webbing will tear out of the energy absorber cover. There should be no evidence of elongation
- Step 4:** All labels should be present and fully legible. See section 11.0.
- Step 5:** If inspection reveals an unsafe or defective condition, remove the rope grab from service and destroy, or contact an authorized service center for repair.
- Step 6:** Record the inspection date and results in the inspection log in the back of this manual.

IMPORTANT: *Do not alter or attempt to repair the rope grab. Do not make substitutions for the rope grab parts. Repairs may only be performed by an authorized service center.*

8.4 VERTICAL LIFELINE INSPECTION

- Step 1:** Inspect lifeline hardware (snap hooks, ferrules, thimbles, etc.). These items must not be damaged, broken or distorted. These items must be free of sharp edges, burrs, cracks, worn parts, or corrosion. Hook gates must move freely and lock upon closing.
- Step 2:** Inspect rope for concentrated wear. Material must be free of frayed strands, broken yarns, cuts, abrasions, burns, and discoloration. The rope must be free of knots, excessive soiling, paint buildup, and rust staining. Rope splices must be tight, with five full tucks, and thimbles must be held firmly by the splice. Check for chemical or heat damage; indicated by brown, discolored, or brittle areas. Check for ultraviolet damage; indicated by discoloration and splinters and slivers along the

rope surface. All of the above factors are known to reduce rope strength. Damaged or questionable rope should be replaced.

- Step 3.** Inspect labels. All labels must be present and fully legible. See section 11.0.
- Step 4.** Inspect each system component or subsystem according to manufacturer's instructions.
- Step 5.** If inspection reveals an unsafe or defective condition, remove the rope grab from service and destroy, or contact an authorized service center for repair.
- Step 6.** Record the inspection date and results in the inspection log included in the back of this manual.

8.5 HINGED ROOD ANCHOR INSPECTION

- Step 1.** Inspect the Roof Anchor for physical damage. Look carefully for any signs of cracks, dents, or deformities in the metal. Check for bending, the roof anchor legs should be flat. Rivets should be securely attached and fully clinched (not pulling through hole).
- Step 2.** Inspect the Roof Anchor for signs of excessive corrosion.
- Step 3.** Ensure the condition of the roof anchor will support the Roof Anchor loads. An anchor connected to rotten or deteriorated wood should not be used.
- Step 4:** Ensure the Roof Anchor is still securely attached to the support structure. If it has become loose, do not use it.
- Step 5:** If inspection reveals a defective condition, remove unit from service immediately and destroy, or contact a factory authorized service center for repair.
- Step 6:** Record the inspection date and results in the inspection log included in the back of this manual.

8.6 CONCRETE ANCHOR INSPECTION

- Step 1:** Inspect the D-ring, plate, and bolts for physical damage. Look carefully for any signs of cracks, dents, or deformities in the D-ring. Ensure that nuts are tightened to proper torque.
- Step 2:** Inspect the D-ring, plate, and bolts for signs of corrosion.
- Step 3:** Ensure that the condition of the structure will support the anchor loads (see "Anchorage Strength Requirements"). An anchor connected to questionable material or surfaces should not be used.
- Step 4:** Ensure that the anchor is securely attached at all times.
- Step 6:** If inspection reveals a defective condition, remove unit from service immediately and destroy, or contact a factory authorized service center for repair.
- Step 7:** Record the inspection date and results in the inspection log included in the back of this manual.

8.7 WIRE ROPE SLING AND WEB SLING INSPECTION

- Step 1.** Inspect the anchorage connector hardware, including, wire rope, D-rings, and O-rings. These items must not be damaged, broken, distorted or have any sharp edges, burrs, cracks, worn parts, or corrosion.
- Step 2.** Inspect the anchorage connector webbing and stitching. The webbing must be free of frayed, cut or broken fibers. Check for tears, abrasions, mold, or discoloration. The webbing must be free of knots, excessive soiling, heavy paint build-up, and rust staining. Check for chemical or heat damage, indicated by brown, discolored, or brittle areas. Check for ultraviolet degradation, indicated by discoloration and the presence of splinters or slivers on the webbing surface. Check for pulled or cut stitches. Broken stitches may be an indication that the anchorage connector has been impact loaded and must be removed from service. All the above factors are known to reduce the strength of the anchorage connector. Damaged or questionable anchorage connectors must be removed from service.
- Step 3.** On wire rope models, inspect wire rope for cuts, kinks, broken wires, bird-caging, corrosion, welding splatter, chemical contact areas, or severely abraded areas. Inspect ferrules for cracks or damage and inspect wire rope for corrosion and broken wires. Damaged or questionable anchorage connectors must be removed from service.
- Step 4.** Check that all labels are present and fully legible. See section 11.0

Step 5. If inspection reveals an unsafe or defective condition, remove the anchorage connector from service and destroy it.

Step 6. Record the inspection date and results in the inspection log included in the back of this manual.

8.8 SELF RETRACTING LIFELINE WIRE ROPE AND HOUSING INSPECTION

CAUTION: Device should be stored with wire rope retracted during periods of non-use. If after inspection there is any doubt as to the safety or appearance of the device, it should be removed from service and returned to PROTECTA for further inspection.

A. HOUSING

Step 1. Inspect the connector at top of device and ensure freedom of movement. Check for signs of distortion, cracks, burns, or worn parts and ensure that keeper is closed.

Step 2. Inspect The nut and bolt retaining connecting hook for signs of distortion, cracks, burns, and wear.

Step 3. Inspect. The main housing for signs of distortion or cracks, that the housing sections fit together with no gaps, and that all screws and rivets are present and tight.

Step 4. Inspect the device for spring action; the entire length of the wire rope should retract easily and fully after extension.

Step 5. Inspect the locking action of the device: jerk on the end of the wire rope several times to ensure the wire rope locks each time.

Step 6. Inspect the snap hook for signs of distortion, cracks, burns, and wear.

Step 7. Check that all labels are present and fully legible.

Step 8. Inspect the entire device for corrosion.

Step 9. Record the inspection date and results in the inspection log included in the back of this manual.

B. WIRE ROPE INSPECTION

CAUTION: Before beginning this procedure ensure that you are wearing gloves as broken wires along the wire rope can cause severe cuts and lacerations.

Step 1. Begin the wire rope inspection procedure at the ferrule, check that it is correctly fitted and there are no signs of distortion, cracks, or corrosion.

Step 2. Check mechanical swages for signs of cracks, distortion, or corrosion-ensure that they are fitted correctly and are not cutting.

Step 3. Pass the wire rope slowly through your hands and flex it every few inches to inspect for broken wires.

Step 4. Check the entire length of the wire rope for signs of deterioration or damage such as:
Mechanical damage/crushing: Crushing the wire rope often results in a flattened or bent section of the wire rope.

Mechanical damage/cutting: Movement over sharp edges or projections while the wire rope is under tension can result in damaged strands and broken wires.

Abrasion: The outer wire strands appear flattened and are brighter in appearance.

Strand Core Protrusion: Core protrusion usually results from the wire rope having been subject to a shock load.

Kinking: Kinking occurs by the deformation of the wire rope during handling when a loop is formed and then tightened without allowing for rotation about its axis. Typical examples of localized wear and deformation are created at a previously kinked portion of the wire rope.

Corrosion: The presence of corrosion on the exterior surface of the wire rope is recognizable by its roughness and pitting. Wire breaks will generate from these cracks or pitting.

Electric Arcing/Heat damage: Heat damage is noticeable by a blue coloring on the wire surface or by fusion of the wire surface and the presence of welding signs.

Step 5. Snap Hooks: Check snap action, ensure that the return spring is functioning properly and that there is not sideways play on the latch in the closed position. Check the hooks for distortion, sharp edges,

burrs, cracks, and worn parts. For plated components check for deterioration in the protection and for signs of corrosion.

Step 6. Check that all labels are present and fully legible. See section 11.0.

Step 7. Record the inspection date and results in the inspection log included in the back of this manual.

8.9 HORIZONTAL LIFELINE (HLL) INSPECTION

A. BEFORE EACH INSTALLATION

System components must be formally inspected by a qualified person, other than the user, at least annually. Formal inspections should concentrate on visible signs of deterioration or damage to the system components. Items found to be defective must be replaced. Do not use components if inspection reveals an unsafe or defective condition. Record results of each inspection in the inspection log included in the back of this manual.

B. INSTALLED SYSTEMS

An inspection of the horizontal lifeline system by a qualified person must be conducted after the system is installed. The system must be periodically inspected by a qualified person when left installed for an extended period, and prior to each day's use. Periodic inspections should be performed at least monthly, or more frequently when site conditions and use warrant. Inspections of installed systems should include the following inspection steps.

Step 1. Inspect all metal components (hooks, O-rings, rope tensioner, etc.) for cracks, deformities, corrosion, or other damage that may affect their strength or operation.

Step 2. Inspect rope for concentrated wear. Material must be free of frayed strands, broken yarns, cuts, abrasions, burns, and discoloration. The rope must be free of knots, excessive soiling, paint build-up, and rust staining. Inspect ferrules for cracks or other damage. Thimble must be held firmly by the ferrule. Check for chemical or heat damage; indicated by brown, discolored, or brittle areas. Check for ultraviolet damage; indicated by discoloration, splinters, and splinters along the rope surface. All of the above factors are known to reduce rope strength.

Step 3. Inspect system labels. The labels must be present and fully legible. See section 11.0.

Step 4. Record the inspection date and results in the inspection log included in the back of this manual.

If inspection reveals an unsafe or defective condition, remove unit from service and destroy, or contact PROTECTA for possible repair.

8.10 HARNESS INSPECTION

Inspection: Harnesses must be inspected on an annual basis by a competent person. This person shall decide whether the harness is to be removed from service or not. During the course of work, all reasonable efforts should be made to ensure that the harness is protected from potential damage, i.e. cuts, burns, caustic chemical exposure, abrasive elements, etc. If the harness is used in an environment where dangers such as this are prevalent, the harness should be inspected for damage both before and after use.

Before each use inspect the full body harness according to the following steps.

Step 1. Inspect harness hardware (buckles, D-rings, back pad, loop keepers); These items must not be damaged, broken, distorted, and must be free of sharp edges, burrs, cracks, worn parts, or corrosion. PVC coated hardware must be free of cuts, rips, tears, holes, etc. in the coating to ensure non-conductivity. Ensure buckles work freely. Inspect parachute buckle spring.

Step 2. Inspect webbing; material must be free of frayed, cut, or broken fibers. Check for tears, abrasions, mold, burns, or discoloration. Inspect stitching; Check for pulled or cut stitches. Broken stitches may be an indication that the harness has been impact loaded and must be removed from service.

Step 3. Inspect labels; All labels should be present and fully legible. See section 11.0.

Step 4. Inspect each system component or subsystem according to manufacturer's instructions.

Step 5. If inspection reveals a defective condition, remove unit from service immediately and destroy.

Step 6. Record the inspection date and results in the inspection log included in the back of this manual.

9.0 CLEANING AND MAINTENANCE

9.1 ROPE GRAB

- A. Periodically clean the rope grab using water and a mild detergent. Clean the label as required.
- B. Replacement parts and additional maintenance and service procedures must be completed by an authorized service center. An authorization and return number must be issued by PROTECTA.
- C. Clean and store system components according to manufacturer's instructions.
- D. Store the rope grab in a clean and dry environment out of direct sunlight. Avoid areas with chemical vapors. Inspect the rope grab after extended storage.

9.2 VERTICAL LIFELINE

- A. Clean the lifeline with water and a mild detergent. Wipe hardware dry with a clean, dry cloth and hang to air dry. Do not force dry with heat. An excessive build-up of dirt, paint, etc. may prevent the lifeline from working properly, and in severe cases, weaken the rope.
- B. Additional maintenance and servicing procedures must be completed by and authorized service center. Authorization must be in writing. Do not disassemble this equipment.
- C. Store the lifeline in a cool, dry, clean environment, out of direct sunlight. Avoid areas where chemical vapors may be present. Thoroughly inspect the lifeline after extended storage.

9.3 HINGED ROOF ANCHOR

- A. No scheduled maintenance is required. If you have any questions concerning the condition of your Roof Anchor, or have any doubt about putting it into service, contact PROTECTA immediately.
- B. Additional maintenance and servicing procedures (i.e. replacement parts) must be completed by a factory authorized service center. Authorization must be in writing.

9.4 CONCRETE ANCHOR

- A. No scheduled maintenance is required. If you have any questions concerning the condition of your AJ720A Concrete Anchor, or have any doubts about putting it into service, contact PROTECTA. Additional maintenance and servicing procedures (i.e. replacement parts) must be completed by PROTECTA. Unused components must be stored in a clean dry location.

9.5 ANCHOR SLING

- A. Clean anchorage connector with water and a mild detergent solution. Wipe off hardware with a clean, dry cloth and hang to air dry. Do not force dry with heat. An excessive build-up of dirt, paint, etc. may prevent the anchorage connector from working properly, and may degrade the webbing to a point where it has become weakened and should be removed from service. If you have questions concerning the condition of your anchorage connector, or have any doubt about putting it into service, contact Protecta.
- B. Store the anchorage connector in a cool, dry, clean environment, out of direct sunlight. Avoid areas where chemical vapors exist. Thoroughly inspect the anchorage connector after extended storage.

9.6 SELF RETRACTING LIFELINE

- A. Wipe off all surface dirt, mud, dust, etc. with a damp sponge. To clean off grease or oil use a mild solution of water and household detergent. Complete by sponging with clear water and completely dry with a clean cloth. After cleaning the fall arrest device, it should be allowed to dry thoroughly in a hanging position free from excessive heat or steam exposure.
- B. Store the lifeline in a cool, dry, clean environment, out of direct sunlight. Avoid areas where chemical vapors may be present. Thoroughly inspect the SRL after extended storage.

9.7 HORIZONTAL LIFELINE

- A. The HLL components require no scheduled maintenance, other than repair or replacement of items found defective during inspection. If components become heavily soiled with grease, paint, or other substances, clean with appropriate cleaning solutions. Do not use caustic chemicals that could damage system components. Store HLL components in a clean, dry, cool, enclosure.

9.8 FULL BODY HARNESS

- A. Clean full body harness with water and a mild soap solution. Do not use bleach or bleach solutions. Wipe off hardware with a clean, dry cloth, and hang to air dry. Do not force dry with heat. An excessive buildup of dirt, paint, etc. may prevent the full body harness from working properly, and in severe cases

degrade the webbing to a point where it weakens and should be removed from service. More information on cleaning is available from PROTECTA. If you have questions concerning the condition of your harness, or have any doubt about putting it into service contact PROTECTA.

- B. Additional maintenance and servicing procedures must be completed by a factory authorized service center. Authorization must be in writing. Do not attempt to disassemble the unit.
- C. Store full body harnesses in a cool, dry, clean environment out of direct sunlight. Avoid areas where chemical vapors may exist. Thoroughly inspect the full body harness after extended storage.

10.0 SPECIFICATIONS

10.1 ROPE GRAB AND VERTICAL LIFELINE SPECIFICATIONS

A. 1/2 IN. ROPE GRAB

Material: High strength electro-polished stainless steel rope grab body, polyester webbing (shock absorbing lanyard), polyester/polypropylene blended 3-strand twisted rope.

Weight: 1.78 lbs. (rope grab and shock absorbing lanyard.)

Size: 2.25 in. X 3.25 in. X .94 in. (rope grab), 1.75 in. wide X 2 ft. long (unextended length) shock absorbing lanyard

Snap Hook: Drop forged, alloy steel self locking snap hook, 5,000 lbs. tensile strength.

Carabiner: Drop forged, alloy steel self locking gate 5,000 lbs. tensile strength.

B. 5/8 IN. ROPE GRAB

Material: High strength electro-polished stainless steel rope grab body, polyester webbing (shock absorbing lanyard), polyester/polypropylene blended 3-strand twisted rope.

Weight: 1.78 lbs. (rope grab and shock absorbing lanyard.)

Size: 2.25 in. X 3.25 in. X .94 in. (rope grab), 1.75 in. wide X 2 ft. long (unextended length) shock absorbing lanyard

Snap Hook: Drop forged, alloy steel self locking snap hook, 5,000 lbs. tensile strength.

Carabiner: Drop forged, alloy steel self locking gate 5,000 lbs. tensile strength.

C. VERTICAL LIFELINE SPECIFICATIONS:

50 ft., 1/2 in. dia. or 5/8 in. dia. Blended Polyester/Polypropylene Rope - Tensile Strength: 5,600 lbs.

Snap hook: Zinc plated stamped steel

Weight: 3.88 lbs. (rope & hook)

Table 1 - Lifeline Elongation						
Lifeline Material	Lifeline Length					
	25 feet	50 feet	75 feet	100 feet	150 feet	175 feet
1/2 in. Blended Polyester/Polypropylene	3.5 feet	7.0 feet	10.5 feet	14.0 feet	17.5 feet	24.5 feet
5/8 in. Blended Polyester/Polypropylene	3.0 feet	6.0 feet	9.0 feet	12.0 feet	18.0 feet	21.0 feet

10.2 HINGED ROOF ANCHOR SPECIFICATIONS

Material: Forged alloy D-ring and 1/8" thick steel

Minimum Breaking Strength: 3,600 lbs.

Weight: 1.8 lbs.

Size: 5/8" x 4" x 17"

Capacity: 310 lbs. (one person)

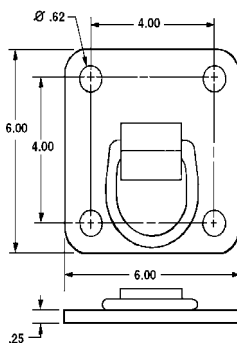

Anchor Plate

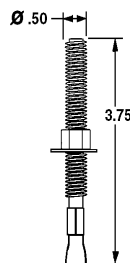

Anchor Bolt

10.3 CONCRETE ANCHOR SPECIFICATIONS

A. ANCHOR PLATE AND D-RING

Material: Zinc plated stamped Steel D-ring. Painted steel plate.

Minimum breaking strength: 5,400 lbs. minimum

Capacity: 310 lbs, total (one person, clothing, equipment).

B. ANCHOR BELTS

Length: 3.75 in.

Diameter: .50 in.

Specifications: Meets GSA Specification FF-S-325, Group II, Type 4, Class 1. ASTM E488.7.0.
For 2,000 PSI minimum concrete.

10.4 ANCHOR STRAP SPECIFICATIONS

A. AJ74710 WEB STRAP CHOKER ANCHOR SLING

Hardware: 2-in. and 3-in. forged alloy steel D-rings.

Webbing: 1 3/4-inch polyester strength member, 3-inch wear pad.

Minimum Breaking Strength: 5,000 lbs. when loaded within the recommended working range.

Capacity: 310 lbs. (one person)

Meets ANSI Z359.1, and OSHA requirements.

B. AJ450A WEB SLING ANCHOR STRAP:

Hardware: Forged alloy steel D-ring, alloy steel adjuster buckle.

Webbing: 1 3/4-inch polyester strength member, 3-inch wear pad.

Minimum Breaking Strength: 5,000 lbs. when loaded within the recommended working range.

Capacity: 310 lbs. (one person)

Meets ANSI Z359.1, and OSHA requirements.

10.5 SELF RETRACTING LIFELINE SPECIFICATIONS

A. AD211B

11 ft. total working length

3/16 in. galvanized wire rope

Aluminum housing

AJ521A snap hook

Meets OSHA 1926 and ANSI Z359.1

Weight: 5.2 lbs.

B. AD111A

11 ft. total working length

1 in. web

Aluminum housing

AJ520A snap hook

Meets OSHA 1926 and ANSI Z359.1

Weight: 2.8 lbs.

C. AD212AG

30 ft. total working length

3/16 in. galvanized wire rope

Thermoplastic casing

AJ521A snap hook

Meets OSHA 1926 and ANSI Z359.1

Weight: 9.8 lbs.

10.6 HORIZONTAL LIFELINE SPECIFICATIONS

Materials:

Rope Tensioner: Steel, plated

O-rings: Alloy steel, plated

Lifeline Rope: Nylon

Rope Tensioner Strap: Polyester/Nylon

Snap Hooks: Alloy steel, plated

Carabiners: High tensile alloy steel, plated

Tie-off Adaptor: Polyester web, plated alloy steel hardware

10.7 FULL BODY HARNESS SPECIFICATIONS

Materials:

Protecta Full Body Harnesses may be constructed of one or a combination of the following materials :

Web : Nylon, polyester, or Kevlar®

Connectors : Forged or stamped steel

INSPECTION AND MAINTENANCE LOG

SERIAL NUMBER:			
MODEL NUMBER:			
DATE PURCHASED:			DATE OF FIRST USE:

INSPECTION DATE	INSPECTION ITEMS NOTED	CORRECTIVE ACTION	MAINTENANCE PERFORMED
Approved By:			
Approved By:			
Approved By:			
Approved By:			
Approved By:			
Approved By:			
Approved By:			
Approved By:			
Approved By:			
Approved By:			
Approved By:			
Approved By:			
Approved By:			
Approved By:			

INSPECTION DATE	INSPECTION ITEMS NOTED	CORRECTIVE ACTION	MAINTENANCE PERFORMED
Approved By:			
Approved By:			
Approved By:			
Approved By:			
Approved By:			
Approved By:			
Approved By:			
Approved By:			
Approved By:			
Approved By:			
Approved By:			
Approved By:			
Approved By:			
Approved By:			
Approved By:			
Approved By:			
Approved By:			
Approved By:			
Approved By:			
Approved By:			
Approved By:			
Approved By:			
Approved By:			
Approved By:			
Approved By:			

INSPECTION DATE	INSPECTION ITEMS NOTED	CORRECTIVE ACTION	MAINTENANCE PERFORMED
Approved By:			
Approved By:			
Approved By:			
Approved By:			
Approved By:			
Approved By:			
Approved By:			
Approved By:			
Approved By:			
Approved By:			
Approved By:			
Approved By:			
Approved By:			
Approved By:			
Approved By:			
Approved By:			
Approved By:			
Approved By:			
Approved By:			
Approved By:			
Approved By:			
Approved By:			

LIMITED LIFETIME WARRANTY

Warranty to End User: D B Industries, Inc., dba CAPITAL SAFETY USA ("CAPITAL SAFETY") warrants to the original end user ("End User") that its products are free from defects in materials and workmanship under normal use and service. This warranty extends for the lifetime of the product from the date the product is purchased by the End User, in new and unused condition, from a CAPITAL SAFETY authorized distributor. CAPITAL SAFETY'S entire liability to End User and End User's exclusive remedy under this warranty is limited to the repair or replacement in kind of any defective product within its lifetime (as CAPITAL SAFETY in its sole discretion determines and deems appropriate). No oral or written information or advice given by CAPITAL SAFETY, its distributors, directors, officers, agents or employees shall create any different or additional warranties or in any way increase the scope of this warranty. CAPITAL SAFETY will not accept liability for defects that are the result of product abuse, misuse, alteration or modification, or for defects that are due to a failure to install, maintain, or use the product in accordance with the manufacturer's instructions.

CAPITAL SAFETY'S WARRANTY APPLIES ONLY TO THE END USER. THIS WARRANTY IS THE ONLY WARRANTY APPLICABLE TO OUR PRODUCTS AND IS IN LIEU OF ALL OTHER WARRANTIES AND LIABILITIES, EXPRESSED OR IMPLIED. CAPITAL SAFETY EXPRESSLY EXCLUDES AND DISCLAIMS ANY IMPLIED WARRANTIES OF MERCHANTABILITY OR FITNESS FOR A PARTICULAR PURPOSE, AND SHALL NOT BE LIABLE FOR INCIDENTAL, PUNITIVE OR CONSEQUENTIAL DAMAGES OF ANY NATURE, INCLUDING WITHOUT LIMITATION, LOST PROFITS, REVENUES, OR PRODUCTIVITY, OR FOR BODILY INJURY OR DEATH OR LOSS OR DAMAGE TO PROPERTY, UNDER ANY THEORY OF LIABILITY, INCLUDING WITHOUT LIMITATION, CONTRACT, WARRANTY, STRICT LIABILITY, TORT (INCLUDING NEGLIGENCE) OR OTHER LEGAL OR EQUITABLE THEORY.



A Capital Safety Company

CSG USA & Latin America

3833 SALA Way
Red Wing, MN 55066-5005
Toll Free: 800.328.6146
Phone: 651.388.8282
Fax: 651.388.5065
solutions@capitalsafety.com

CSG Canada

260 Export Boulevard
Mississauga, ON L5S 1Y9
Phone: 905.795.9333
Toll-Free: 800.387.7484
Fax: 888.387.7484
info.ca@capitalsafety.com

CSG Northern Europe

Unit 7 Christleton Court
Manor Park
Runcorn
Cheshire, WA7 1ST
Phone: + 44 (0)1928 571324
Fax: + 44 (0)1928 571325
csgne@capitalsafety.com

CSG EMEA

(Europe, Middle East, Africa)

Le Broc Center
Z.I. 1ère Avenue
5600 M B.P. 15 06511
Carros
Le Broc Cedex
France
Phone: + 33 4 97 10 00 10
Fax: + 33 4 93 08 79 70
information@capitalsafety.com

CSG Australia & New Zealand

20 Fariola Street
Silverwater
Sydney NSW 2128
AUSTRALIA
Phone: +(61) 2 9748 0335
Toll-Free : 1 800 245 002 (AUS)
Toll-Free : 0800 212 505 (NZ)
Fax: +(61) 2 9748 0336
sales@capitalsafety.com.au

CSG Asia

Singapore:
16S, Enterprise Road
Singapore 627666
Phone: +65 - 65587758
Fax: +65 - 65587058
inquiry@capitalsafety.com

Shanghai:

Rm 1406, China Venturetech Plaza
819 Nan Jing Xi Rd,
Shanghai 200041, P R China
Phone: +86 21 62539050
Fax: +86 21 62539060

www.capitalsafety.com



Certificate No. FM 39709