

**3M**

**Quick  
Reference**

**product and  
technical guide**

**February  
2000**

---

**3M VISUAL SYSTEMS DIVISION**

# TABLE OF CONTENTS

WARRANTY INFORMATION .....	2
INTRODUCTION .....	3
TELEPHONE DIRECTORY .....	4
TECHNICAL LITERATURE .....	5
OHP SCREEN LUMEN COLOR FREE RANGE CHARTS .....	6-7
FRESNEL LENS/STAGE GLASS CHART .....	8
OVERHEAD PROJECTOR LAMP GUIDE .....	9
HISTORY OF 3M OVERHEAD PROJECTORS .....	10-11
OVERHEAD PROJECTORS .....	12-19
ROLLER ATTACHMENTS .....	20
HISTORY OF 3M INFRARED TRANSPARENCY MAKERS .....	21
TRANSPARENCY MAKERS .....	22
HISTORY OF 3M EPS PRODUCTS .....	23
EPS PROJECTOR TO SCREEN DISTANCE TABLES .....	24-25
ELECTRONIC PRESENTATION SYSTEMS .....	26-40
TRANSPARENCY FILM FOR COPIERS .....	41-42
INFRARED (IR) TRANSPARENCY FILM .....	42
COLOR COPIER TRANSPARENCY FILM .....	43
COLOR COPIER GUIDE .....	43-44
COLOR LASER PRINTER GUIDE .....	45
BLACK AND WHITE COPIER TRANSPARENCY .....	46-55
BLACK AND WHITE TRANSPARENCY FILM .....	56-57
COMPUTER GRAPHICS FILM REFERENCE GUIDE .....	58-60
THERMAL TRANSFER PRINTER FILM .....	61
WRITE-ON FILM .....	61
RELATED PRODUCTS .....	62
GLOSSARY OF OVERHEAD TERMS .....	63-64
GLOSSARY OF EPS TERMS .....	65-66
GLOSSARY OF COMPUTER PRINTER TYPES .....	66
GLOSSARY OF INK JET TERMS .....	67

## WARRANTY INFORMATION

**All service should be conducted by a qualified technician to prevent damage to the equipment or personal injury.**

Warranty service is provided only by 3M Visual Systems Authorized Service Dealers. To locate the Authorized Service Dealer nearest you, call: **1-800-328-1371**

### **New Machine Warranty and Limitation of Liability:**

**Warranty.** 3M warrants this product against any defects in material and workmanship for a period of time from the date of purchase (warranty length varies by model number). Proof of purchase date will be required with any warranty claim. In the event this product is found to be defective within the warranty period, 3M's only obligation and your exclusive remedy shall be replacement of any defective parts and labor. To obtain warranty service, the machine must be delivered or shipped to a 3M authorized servicing dealer.

**Exclusions to Warranty.** The following items are considered consumable and are not covered by the above warranty: Lamps, fuses, copy belts. **Limitation of Liability.** THE FOREGOING WARRANTY IS MADE IN LIEU OF ALL OTHER WARRANTIES, EXPRESSED OR IMPLIED, AND 3M SPECIFICALLY DISCLAIMS ANY IMPLIED WARRANTY OF MERCHANTABILITY AND FITNESS. 3M SHALL NOT BE LIABLE FOR ANY DAMAGES, DIRECT, CONSEQUENTIAL, OR INCIDENTAL, ARISING OUT OF THE USE OR INABILITY TO USE THIS PRODUCT.

**Important:** The above warranty shall be void if customer fails to operate product in accordance with 3M's written instructions. This warranty gives you specific legal rights and you may have other rights which vary from state to state.

### **Transparency Films Warranty and Limitation of Liability:**

3M Company warrants this transparency product against defects in material and workmanship, under normal use and storage conditions, for a period of one year from date of purchase. In the event this product is found to be defective within the warranty period, 3M will replace or refund the purchase price of the product at its option. Like other dyes, the dyes used in color transparency film may change with time, therefore, the film will not be replaced because of, or warranted against, any change in color. Notification of any defect must be given immediately to your local 3M authorized dealer along with original packaging. This warranty shall not apply if shown by 3M Company that the defect was caused by improper storage or misuse. EXCEPT FOR PERSONAL INJURY, 3M COMPANY SHALL NOT BE LIABLE IN EITHER TORT OR CONTRACT FOR ANY LOSS OR DAMAGE, DIRECT, CONSEQUENTIAL OR INCIDENTAL, ARISING OUT OF THE USE OR MISUSE OR INABILITY TO USE THIS PRODUCT. Some states do not allow the exclusion or limitation of incidental or consequential damages, so the above limitation may not apply to you. THIS WARRANTY GIVES YOU SPECIFIC LEGAL RIGHTS AND YOU MAY ALSO HAVE OTHER RIGHTS WHICH VARY FROM STATE TO STATE.

## INTRODUCTION

**This Quick Reference Product and Technical Guide is a convenient reference of 3M Visual Systems Division products.**

**This guide uses up to three different numbers to designate a product. Example:**

PP2500 - Product Number  
78-6969-7011-6 - Stock Order Number  
051125-01810-4 - Universal Product Code

**NOTE:** Availability of products, stock numbers, specifications, etc., are subject to change without notice.

**Additional copies may be ordered for \$3.00 each. Order publication number 78-6970-1987-1.**

U.S. Orders:  
3M Customer Information Center  
Hale Avenue Business Center  
3M bldg. 506, POCS Destination Code 0444  
835 Hale Ave. North  
Oakdale, MN 55128      Fax: 651-736-6320

**NOTE:** All orders outside of the USA must be placed through the International Order Department.

# TELEPHONE DIRECTORY

## 3M Visual Systems Division

THESE NUMBERS APPLY ONLY TO 3M VISUAL SYSTEMS DIVISION  
For other 3M Products, call 3M Product Information  
800-3M-HELPS (800-364-3577)

Advertising Department		512-984-7137
<b>OFSD Customer Service</b>		
Consumer		800-854-4266
Tech./Sales		800-865-4223
Export Department (3M)		800-243-3636
International Department - Information		512-984-7114
Literature Ordering - Advertising Literature	Fax	512-349-3150
	Phone	512-349-3147
Literature Ordering - International		651-733-2910
Marketing Department		512-984-7127
<b>ORDERDEPARTMENT</b>		
<b>Visual Systems Division</b>	<b>Phone</b>	<b>800-447-0388</b>
	Fax	800-446-4516
<b>PARTS DEPARTMENT (Customer Orders)</b>		<b>800-650-8429</b>
Parts Ordering (Dealers)	Fax	800-650-9268
Sales Department		512-984-7150

### TECHNICAL ASSISTANCE & PRODUCT INFORMATION

# 1-800-328-1371

(Fax) 512-984-5105

Internet: [www.3m.com/presentation](http://www.3m.com/presentation)

Email:

OHP - [presentations@mmm.com](mailto:presentations@mmm.com)

EPS - [techsupport@mmm.com](mailto:techsupport@mmm.com)

Hours:

EPS - 24 hrs., 7 days per week

OHP - 7:30 am to 5:30 pm Central Time

## TECHNICAL LITERATURE

**U.S. Orders: 3M Customer Information Center**  
**Hale Avenue Business Center**  
**3M bldg. 506, POCS Destination Code 0444**  
**835 Hale Ave. North**  
**Oakdale, MN 55128**                      **Fax: 651-736-0707**

**NOTE:** All orders outside of the USA must be placed through the International Order Department.

<b>VSD SERVICE COLLECTIONS</b>	<b>DATE</b>	<b>ORDER NUMBER</b>
Current Models (Service & Parts manuals + M4550)		78-6970-6386-1
Discontinued Models (213/313, 900/955, 2010, 2100, 4400 & 9600 Service & Parts manuals)		78-6970-7478-5
OHP Projector Service Information Resource (CD-ROM) Rev C	(Aug 99)	78-6970-7536-0

<b>OWNER'S MANUALS</b>	<b>DATE</b>	<b>ORDER NUMBER</b>
900 (Overhead Projectors)	(Nov 89)	78-6970-2547-2
Highland 1610 (OHP) Eng., Port., Sp. Rev A	(Mar 00)	78-6970-9016-1
Highland 1610 (OHP) Eng., Fr., Sp. Rev B	(Jan 00)	78-6970-9008-8
1700 (OHP) Eng, Fr., Sp, Port	(Sep 97)	78-6970-7515-4
2000 (Overhead Projector)	(Apr 92)	78-6970-2479-8
2100 (Overhead Projectors)	(Sep 90)	78-6970-1328-8
2770 (OHP) US/Canada	(Jul 91)	78-6970-3924-2
2770 (OHP) European	(Jul 91)	78-6970-3925-9
4400 (Overhead Projectors)	(Jul 94)	78-6970-5572-7
9000 (Overhead Projectors)	(Aug 99)	78-6970-4916-7
9600 (Overhead Projector)	(Feb 95)	78-6970-6570-0
9700 (OHP) Eng, Fr, Sp	(Jun 96)	78-6970-5566-9
9700 (OHP) European	(Sep 94)	78-6970-6359-8
9800 (OHP) Eng, Fr, Sp	(Jun 96)	78-6970-5569-3
9800 (OHP) European	(Nov 94)	78-6970-6472-9
9850 (OHP) European	(Apr 95)	78-6970-6781-3
4550 (IR Transparency Maker)	(Mar 94)	78-6970-1326-2
6050 (EPS)	(Jan 98)	DY-0205-1266-0
6100/6400 (EPS) Global	(Apr 96)	DY-0205-1246-2
6650 (EPS)	(Jan 96)	DY-0205-1243-9
6750 (EPS) Global	(Jan 95)	DY-0205-1057-3
MP8020 (EPS)	(Dec 95)	78-6970-7070-0
MP8020 (EPS) Global Rev C	(May 96)	78-6970-6847-2
MP8030 (EPS) Global Rev A	(Jun 96)	78-6970-7246-6
MP8610 (EPS) Global Rev B	(Aug 98)	78-6970-8949-4
MP8620 (EPS) Global Rev B	(Feb 98)	DY-0205-1351-0
MP8625 (EPS) Global Rev B	(Aug 98)	78-6970-8926-2
MP8630 (EPS) Global	(Apr 97)	78-6970-7519-6
MP8635 (EPS) Global Rev A	(Aug 99)	78-6970-8991-6
MP8635B (EPS) Rev B	(Mar 00)	78-6970-9015-3
MP8640 (EPS) Global Rev A	(July 97)	78-6970-7912-3
MP8650 (EPS) Global Rev F	(Feb 97)	78-6970-7312-6
MP8660 (EPS) Global Rev B	(Mar 98)	78-6970-8001-4
MP8670 (EPS) Global Rev A	(Aug 99)	78-6970-8994-0
MP8725 (EPS) Global Rev A	(Mar 99)	78-6970-8966-8
MP8730 (EPS) Global Rev B	(Mar 98)	78-6970-7949-5
MP8740 (EPS) Global Rev A	(Mar 99)	78-6970-8972-6
MP8745 (EPS) Global Rev A	(Aug 99)	78-6970-8993-2
MP8750 (EPS) Global Rev A	(Apr 99)	78-6970-8976-7
MP8780 (EPS) Global Rev A	(Sept 99)	78-6970-9001-3
DC1000 (EPS) Global Rev B	(Feb 00)	78-6970-9004-7

<b>OTHER PUBLICATIONS</b>	<b>DATE</b>	<b>ORDER NUMBER</b>
Lamp Life in Overhead Projectors	(Dec 94)	78-6970-6509-8
Warranty Service Credit form	(Dec 98)	78-6970-2539-9
Quick Reference Guide	(Feb 00)	78-6970-1987-1
Technical Bulletins & Binder		78-6970-6830-8

**TECHNICAL LITERATURE**

# OHP SCREEN LUMEN COLOR FREE RANGE CHARTS

**Model #** 1610  
**ANSI Lumens** 1000

Distance to Screen	48"	60"	72"
Image Size	40"x40"	50"x50"	60"x60"
Effective Screen Lumens	2250	1440	1000

Color Free Range 35"-85"

**Model #** 2000  
**ANSI Lumens** 1600

Distance to Screen	51"	66"	77"	88"	103"	117"	130"	143"
Image Size	40"x40"	50"x50"	60"x60"	70"x70"	84"x84"	96"x96"	108"x108"	120"x120"
Effective Screen Lumens	3600	2304	1600	1176	816	625	494	400

Color Free Range 37"-80"

**Model #** 2770  
**ANSI Lumens** 2200

Distance to Screen	53"	60"	72"	84"	101"	115"	129"	143"
Image Size	40"x40"	50"x50"	60"x60"	70"x70"	84"x84"	96"x96"	108"x108"	120"x120"
Effective Screen Lumens	4950	3168	2200	1616	1122	859	679	550

Color Free Range 37"-100"

**Model #** 9040  
**ANSI Lumens** 2200

Distance to Screen	54"	66"	77"	88"	103"	117"	130"	143"
Image Size	40"x40"	50"x50"	60"x60"	70"x70"	84"x84"	96"x96"	108"x108"	120"x120"
Effective Screen Lumens	4950	3168	2200	1616	1122	859	679	550

Color Free Range 45"-75"

**Model #** 9050  
**ANSI Lumens** 2500

Distance to Screen	54"	66"	77"	88"	130"	117"	130"	143"
Image Size	40"x40"	50"x50"	60"x60"	70"x70"	84"x84"	96"x96"	108"x108"	120"x120"
Effective Screen Lumens	5625	3600	2500	1837	1276	977	772	625

Color Free Range 45"-75"

**Model #** 9060  
**ANSI Lumens** 2500

Distance to Screen	64"	78"	91"	105"	123"	139"	155"	171"
Image Size	40"x40"	50"x50"	60"x60"	70"x70"	84"x84"	96"x96"	108"x108"	120"x120"
Effective Screen Lumens	5625	3600	2500	1837	1276	977	772	625

Color Free Range 45"-70"

**Model #** 9070  
**ANSI Lumens** 2500

Distance to Screen	54"	66"	77"	88"	103"	117"	130"	143"
Image Size	40"x40"	50"x50"	60"x60"	70"x70"	84"x84"	96"x96"	108"x108"	120"x120"
Effective Screen Lumens	5625	3600	2500	1837	1276	977	772	625

Color Free Range 45"-80"

**Model #** 9075  
**ANSI Lumens** 4000

Distance to Screen	54"	66"	77"	88"	103"	117"	130"	143"
Image Size	40"x40"	50"x50"	60"x60"	70"x70"	84"x84"	96"x96"	108"x108"	120"x120"
Effective Screen Lumens	9000	5760	4000	2939	2041	1563	1235	1000

Color Free Range 45"-80"

**Model #** 9080  
**ANSI Lumens** 2500

Distance to Screen	54"	66"	77"	88"	103"	117"	130"	143"
Image Size	40"x40"	50"x50"	60"x60"	70"x70"	84"x84"	96"x96"	108"x108"	120"x120"
Effective Screen Lumens	5625	3600	2500	1837	1276	977	772	625

Color Free Range 45"-75"

# OHP SCREEN LUMEN COLOR FREE RANGE CHARTS

<b>Model #</b>	<b>9085</b>							
<b>ANSI Lumens</b>	<b>4000</b>							
Distance to Screen	54"	66"	77"	88"	103"	117"	130"	143"
Image Size	40"x40"	50"x50"	60"x60"	70"x70"	84"x84"	96"x96"	108"x108"	120"x120"
Effective Screen Lumens	9000	5760	4000	2939	2041	1563	1235	1000
Color Free Range	45"-75"							

<b>Model #</b>	<b>9100</b>							
<b>ANSI Lumens</b>	<b>2800</b>							
Distance to Screen	64"	78"	91"	105"	123"	139"	155"	171"
Image Size	40"x40"	50"x50"	60"x60"	70"x70"	84"x84"	96"x96"	108"x108"	120"x120"
Effective Screen Lumens	6300	4032	2800	2057	1429	1094	864	700
Color Free Range	45"-70"							

<b>Model #</b>	<b>9550</b>							
<b>ANSI Lumens</b>	<b>4000</b>							
Distance to Screen	51"	70"	72"	84"	101"	124"	144"	170"
Image Size	40"x40"	50"x50"	60"x60"	70"x70"	84"x84"	96"x96"	108"x108"	120"x120"
Effective Screen Lumens	9000	5760	4000	2939	2041	1563	1235	1000
Color Free Range	35"-95"							

<b>Model #</b>	<b>9550</b>							
<b>ANSI Lumens</b>	<b>4000</b>							
Distance to Screen	51"	70"	72"	84"	101"	124"	144"	170"
Image Size	40"x40"	50"x50"	60"x60"	70"x70"	84"x84"	96"x96"	108"x108"	120"x120"
Effective Screen Lumens	9000	5760	4000	2939	2041	1563	1235	1000
Color Free Range	35"-95"							

<b>Model #</b>	<b>9700</b>							
<b>ANSI Lumens</b>	<b>4300</b>							
Distance to Screen	61"	74"	86"	98"	114"	129"	143"	158"
Image Size	40"x40"	50"x50"	60"x60"	70"x70"	84"x84"	96"x96"	108"x108"	120"x120"
Effective Screen Lumens	9675	6192	4300	3159	2194	1680	1327	1075
Color Free Range	35"-85"							

<b>Model #</b>	<b>9800</b>							
<b>ANSI Lumens</b>	<b>6000</b>							
Distance to Screen	61"	74"	86"	98"	114"	129"	143"	158"
Image Size	40"x40"	50"x50"	60"x60"	70"x70"	84"x84"	96"x96"	108"x108"	120"x120"
Effective Screen Lumens	13500	8640	6000	4408	3061	2344	1852	1500
Color Free Range	45"-120"							

**Note:** The shaded area designates the color free range of the projector. The dark outline box represents the screen distance and effective lumens at approximately 1500 lumens or greater.

OHP SCREEN LUMEN COLOR FREE RANGE CHARTS



## FRESNEL LENS & STAGE ASSEMBLIES

Sales Model	Stage Aperture	Fresnel Lens Stage Assembly	Stage Glass
213	10"x10"	78-8052-8468-0	
213	10.5"x10.5"	78-8052-8469-8	
213	11.2"x11.2"	78-8052-8467-2	
313	10"x10"	78-8052-8468-0	
394	10"x10"	78-8052-8468-0	
395	10"x10"	78-8052-8468-0	
413	10"x10"	78-8052-8468-0	
429	10.5"x10.5"	78-8052-8469-8	
433	10"x10"	78-8704-4814-5	
905	10.5"x10.5"	78-8064-1645-5	78-8064-1473-2
905D	10.5"x10.5"	78-8064-1645-5	78-8064-1473-2
905W	10.5"x10.5"	78-8064-1645-5	78-8064-1473-2
908	10.5"x10.5"	78-8064-1645-5	78-8064-1473-2
910	10.5"x10.5"	78-8064-1645-5	78-8064-1473-2
920	10.5"x10.5"	78-8064-1645-5	78-8064-1473-2
955	10.5"x10.5"	78-8064-1810-5	78-8073-7221-0
1610	10"x10"		
1706	10"x10"	78-8120-2915-1	78-8114-9027-1
1707	10"x10"	78-8120-2915-1	78-8114-9027-1
1710	10"x10"	78-8120-2915-1	78-8114-9021-4
1715	10"x10"	78-8120-2915-1	78-8114-9021-4
1700-A4	11.5"x11.5"	RO-0038-0223-6	RO-0038-0122-0
2000	10.5"x10.5"	78-8014-7442-6	
2000	10.5"x10.5"	78-8014-6798-2	
2010	10.5"x10.5"	78-8014-7442-6	
2130/	10.5"x10.5"	78-8054-1236-4	78-8054-1076-4
4130	10.5"MASK	78-8054-1018-6	
2140/	10.5"x10.5"	78-8054-1236-4	78-8054-1076-4
4140	10.5"MASK	78-8054-1018-6	
2150/	10.5"x10.5"	78-8054-1236-4	78-8054-1076-4
4150	10.5"MASK	78-8054-1018-6	
2150	11.2"x11.2"	78-8054-1236-4	78-8054-1076-4
	11.2"(A4) MASK	78-8054-1017-8	
2770S	10.5"x10.5"	78-8065-8587-9	
2770S	11.2"x11.2"	78-8065-8588-7	
2770T	10.5"x10.5"	78-8065-8249-6	
2770T	11.2"x11.2"	78-8065-8541-6	
5088	10"x10"	78-8704-4814-5	
6201	10.5"x10.5"	78-8014-7442-6	
	11.2"x11.2"	78-8014-7443-4	
6202	10.5"x10.5"	78-8014-6798-2	
	11.2"x11.2"	78-8014-6799-0	
4405	10.5"x10.5"	78-8096-5791-5	78-8064-1473-2
4406	10.5"x10.5"	78-8096-5791-5	78-8064-1473-2
4407	10.5"x10.5"	78-8096-5791-5	78-8064-1473-2
4410	10.5"x10.5"	78-8096-5791-5	78-8064-1473-2
9040, 9050,			
9060, 9070	10.5"x10.5"	78-8064-1645-5	78-8064-1473-2
9075	10.5"x10.5"	78-8095-8353-3	78-8064-1473-2
9080	10.5"x10.5"	78-8064-1645-5	78-8064-1473-2
9085	10.5"x10.5"	78-8095-8353-3	78-8064-1473-2
9100, 9200	10.5"x10.5"	78-8064-1645-5	78-8064-1473-2
9550	11.2"x11.2"	78-8079-9045-8	78-8079-8975-7
9600	10.5"x10.5"	78-8064-1645-5	78-8064-1473-2
9700	10.5"x10.5"	78-8095-8353-3	78-8064-1473-2
9750	11.2"x11.2"		
9800	11.2"x11.2"	78-8097-3637-0	78-8079-8975-7
9850	11.2"x11.2"	78-8097-3637-0	78-8079-8975-7

# 3M OVERHEAD PROJECTOR LAMP GUIDE

Available only at the 3M Parts Department

Current Models	Lamp	Volts	Watts	Line V.	Part Number
1610	FCS	24	150	120	78-8120-3026-6
1700	ENX	82	360	120/127	78-8011-1186-1
1700-A4	EHJ	24	250	ALL	78-8062-0930-6
	EVD	36	400	ALL	78-8079-8791-8
2000	EVW	82	250	120/127	78-8014-6796-6
	FSX	230	400	230	78-8057-4162-2
	FSY	240	400	240	78-8057-4163-0
2770	ENX	82	360	120	78-8011-1186-1
	EPW	100	360	100	78-8011-1199-4
	FNT	24	275	230/240	78-8054-1175-4
	FSX	230	400	230	78-8057-4162-2
	FSY	240	400	240	78-8057-4163-0
9040	ENX	82	360	120/127	78-8011-1186-1
9050,60,70,80,9100	ENX	82	360	120/127	78-8011-1186-1
9050,60,70,80,9100	FNT	24	275	230/240	78-8054-1175-4
9075, 9085	FXL	82	410	120/127	78-8073-7100-6
9200	FXL	82	410	120/127	78-8073-7100-6
9600, 9700, 9750	FXL	82	410	120/127	78-8073-7100-6
9550, 9800	EVD	36	400	ALL	78-8079-8791-8

## Accessory Lamps

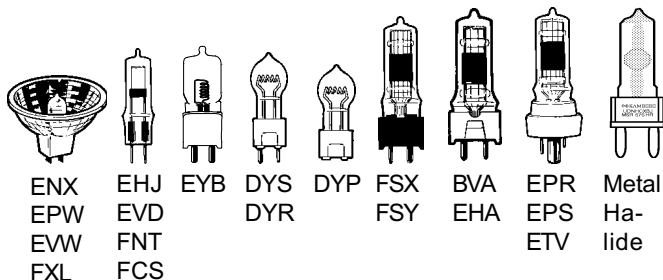

Each package contains one lamp (Available only from the Order Department -- Not available at the 3M St. Paul Parts Department.)			
Lamp	Product #	Stock Number	UPC Code
DYS	HA6006	78-6969-7833-3	051125-58139-4
ENX	HA6000	78-6969-7828-3	051125-58012-0
EVW	HA6002	78-6969-7826-7	051125-58014-4
EVD	HA6009	78-6969-7970-3	051125-58343-5
EYB	HA6010	78-6969-8027-1	051125-58457-9
FNT	HA6001	78-6969-7827-5	051125-58013-7
FXL	HA6005	78-6969-7947-1	051125-58241-4
FCS		78-8120-3026-6	051125-59712-8
Metal Halide (9850)		DY-0210-1120-9	051125-58697-9



3M OVERHEAD PROJECTOR LAMP GUIDE

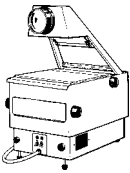

# HISTORY OF 3M OVERHEAD PROJECTORS

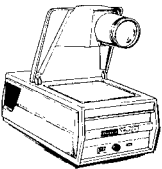
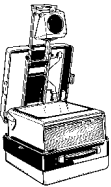
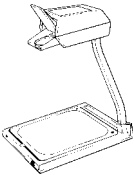
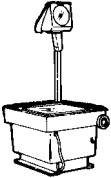
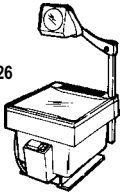
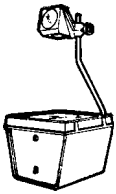
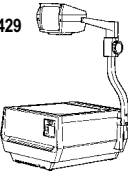
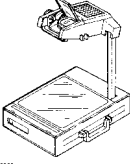
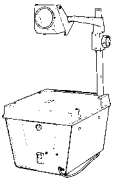
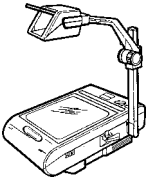
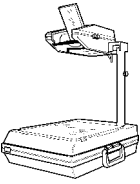
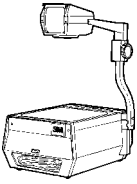
Dates are approximate

<p>1960-1962 <b>Model 42A</b> 500W lamp</p> <p>1962-1964 <b>Model 42B</b> 500W lamp</p> <p>1964-1967 <b>Model 42C</b> 1000W lamp</p> <p>1967-1970 <b>Model 42D</b> 2000W lamp</p> 	<p>1963-1964 <b>Model 66AG</b> 360W lamp</p> <p>1964-1966 <b>Model 66AG</b> 420W lamp</p> <p>1966-1968 <b>Model 66AG</b> 600/1000W lamp</p> <p>1969-1971 <b>Model 66AR</b> 515/900W lamp</p> 
<p>1960-1964 <b>Model 43</b> 500W lamp</p> 	<p>1962-1969 <b>Model 60</b> 420W lamp</p> 
<p>1965-1970 <b>Model 88/5088</b> 400W lamp</p> <p>1970-1989 <b>Model 88/5088</b> 500W lamp</p> 	<p>1967-1970 <b>Model 121/221</b> 600W lamp</p> <p>1968-1970 <b>Model 523</b> 600W lamp</p> 
<p>1968-1970 <b>Model 526</b> 900W lamp</p> <p>1970-1976 <b>Model 521, 522, 526</b> 625W lamp</p> 	<p>1971-1975 <b>Model 566RG</b> 515W lamp</p> <p>1971-1975 <b>Model 567RG</b> 625W lamp</p> 
<p>1976-1989 <b>Model 213, 413, 429</b> 360W lamp</p> 	<p>1980-1987 <b>Model 6200</b> 250W lamp</p> 
<p>1986-1987 <b>Model 1093/1094</b> (Similar to M66) 515W lamp</p> 	<p>1986-1994 <b>Model 2100</b> 275W lamp</p> 
<p>1987-P <b>Model 2000</b> 250W lamp</p> 	<p>1987-1993 <b>Model 313</b> 360W lamp</p> <p>1988-1993 <b>Model 394</b> 360W lamp</p> <p>1988-1993 <b>Model 395</b> 360W lamp</p> 

# HISTORY OF 3M OVERHEAD PROJECTORS

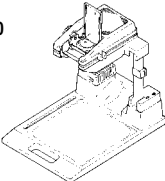
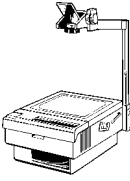
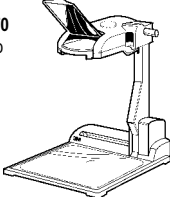
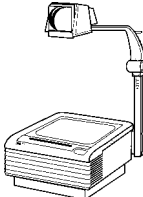
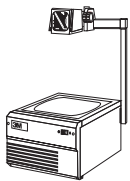
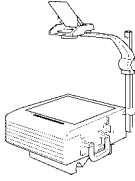
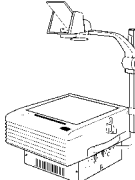
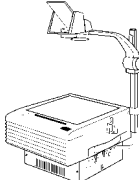
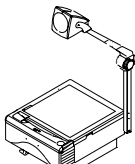
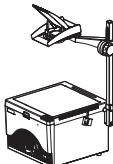
Dates are approximate

<p>1988-1991 <b>Model 2010</b> 275W lamp</p> 	<p>1989-1993 <b>Model 900</b> 360W lamp 1991-1993 <b>Model 955</b> 410W Lamp</p> 
<p>1991-P <b>Model 2770</b> 360W lamp</p> 	<p>1993-P <b>Model 9000</b> 360W lamp 1996-P <b>Model 9075</b> 410W Lamp 1997-P <b>Model 9085</b> 410W Lamp 1993-P <b>Model 9200</b> 410W Lamp 1993-P <b>Model 9550</b> 400W lamp</p> 
<p>1994-1997 <b>Model 4400</b> 360W lamp</p> 	<p>1995-1996 <b>Model 9600</b> 410W lamp 1994-P <b>Model 9700</b> 410W lamp 1997-1999 <b>Model 9750</b> 410W lamp</p> 
<p>1994-P <b>Model 9800</b> 400W lamp</p> 	<p>1996-1999 <b>Model 9850</b> 575W lamp Metal Halide</p> 
<p>1997-P <b>Model 1700</b> 360W lamp</p> 	<p>1998-P <b>Model 1700-A4</b> 250W lamp 400W lamp</p> 
<p>1999-P <b>Model 1610</b> 360W lamp</p> 	

HISTORY OF 3M OVERHEAD PROJECTORS

## 1600 SERIES OVERHEAD PROJECTORS

**HL 1600 AJA**  
**11.5" (293mm) Singlet**  
78-9236-6504-2  
051125-59544-5

---

**1610 AAAM**  
**11.5" (293mm) Singlet**  
78-9236-6505-9  
051125-59545-2

---

**1610 AAAL**  
**11.5" (293mm) Singlet**  
78-9236-6531-5  
051125-59739-5

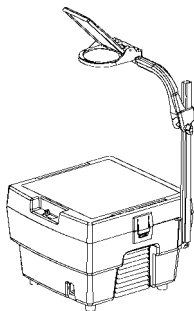

### FEATURES

Average Lumens  
Hour Lamp Life (Avg)  
Fixed Post  
Quiet Fan (<39 db)  
Lamp Included  
2 Year Warranty  
Cool Stage (115°F)  
10" Stage Aperture

### SPECIFICATIONS

Width: 12" (30.48 cm)  
Depth: 13" (33.02 cm)  
Height-Base: 9.75" (24.76 cm)  
Height-Total: 30" (76.2 cm)  
Weight: 12 lbs (5.4 kg)  
Power Cord (3-Wire):

### ACCESSORIES

3M Overhead Cleaner 676

34-8508-7076-2

## 1700 SERIES OVERHEAD PROJECTORS

### 1706AJE

**14" Closed Doublet**

78-9236-6307-0

051125-58908-6

### 1707AJF

**11.5" Closed Singlet**

78-9236-6310-4

051125-58911-6

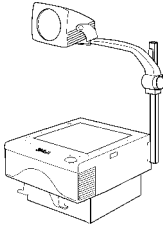

### 1710AJB

**11.5" Closed Singlet**

78-9236-6313-8

051125-58914-7

### 1715AJG

**14" Closed Doublet**

78-9236-6315-3

051125-58916-1

### FEATURES

	1706	1707	1710	1715
Lamp Changer			■	■
ENX Lamp	■	■	■	■
Color Tuning			■	■
10 ft., 3 Wire Power Cord	■	■	■	■
Cord Wrap	■	■	■	■
1 Lamp Included	■	■	■	■
3 Year Warranty	■	■	■	■
Fixed post	■	■	■	■
Replaces Model	4406	4405 4407	4410	4415

### SPECIFICATIONS

	1706	1707	1710	1715
<b>Optical:</b>				
Lamp Life (hrs)	130	130	130	130
Typical Lumens	2000	2000	2000	2000
Stage Aperture: 10"x10"	■	■	■	■
Stage Temperature (°F)	95	95	95	95
<b>Projector Dimensions:</b>				
Height: top of head (in.)	28	29.6	28	28
top of stage (in.)	8.5	8.5	8.5	8.5
Depth (in.)	16.75	16.75	16.75	16.75
Width (in.)	14.2	14.2	14.2	14.2
Weight (lbs.)	17.8	17.8	19.2	19.2
<b>Carton Dimensions:</b>				
Height (in.)	12.5	12.5	12.5	12.5
Depth (in.)	28	28	28	28
Width (in.)	19.3	19.3	19.3	19.3

OVERHEAD PROJECTORS

### ACCESSORIES

AF4310	Roller Film 10 1/4 x 50	78-9020-1282-8	051125-07237-3
HA5651	Presenter's Cart	78-6969-7217-9	051125-07144-4
HA5760	Roller Attachment	78-6969-7214-6	051125-07141-3
HA5792	Dust Cover	78-6969-7216-1	051125-07147-5

### SERVICE PARTS

		1706	1707	1710	1715
<b>Optical:</b>					
Stage Assembly	78-8114-9021-4	■	■		
Stage Assembly	78-8114-9027-1				■
Singlet Head Assembly Kit	78-8114-9010-7		■	■	
Doublet Head Assembly Kit	78-8114-9011-5	■			■
Lens, Singlet	78-8120-2927-6		■	■	
Lens, Doublet	78-8114-8795-4	■			■
Lens Wide Angle, 293 mm	78-8014-8951-5		■	■	

## 2000 OVERHEAD PROJECTOR

**2000 AG**  
**Portable**  
**11.5" (293mm) Singlet**  
78-9236-3732-2  
051125-01389-5

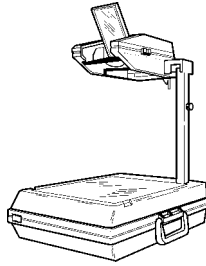

### FEATURES

1600 Average Lumens  
Highly Portable  
Fold Down Post  
Cord Storage  
10 ft., 3 Wire Grounded Power Cord  
Stage Aperture 10.5" x 10.5"  
Reflective Type

### SPECIFICATIONS

#### Physical:

Width: 13" (33.0 cm)  
Depth: 19" (48.2 cm)  
Height - Base: 5" (12.7 cm)  
Height - Total: 21.5" (54 cm)  
Weight: 14 lbs (6.4 kg)

### SERVICE PARTS

#### Cabinet:

Knob - Focus

78-8064-1601-8

#### Optical:

10.5" x 10.5" for Singlet  
Lens - Singlet 11.5" (293 mm)

78-8014-7442-6  
78-8014-8951-5

## 2770 OVERHEAD PROJECTOR

**2770 AJB**  
**(2770 T)**  
**Varifocal Triplet (270-298mm)**  
78-9236-5294-1  
051125-57435-8

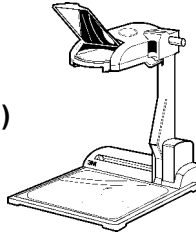

### FEATURES

Varifocal Lens (Triplet)  
Hard-Shell Travel Cover  
Hard Coated Stage  
Lamp Changer and 2 lamps  
Manufactured in USA  
UL/CSA Approved  
10 ft., 3 Wire Grounded Power Cord  
Stage Aperture 10.5" x 10.5"  
Reflective Type  
Illumination (Typical Lumens) - 2200  
One year warranty

### SPECIFICATIONS

#### Physical:

Width: 12.5" (31.7 cm)  
Length: 16.4" (41.8 cm)  
Height - Base: 7/8"  
Height - Total: 16.5" (41.9 cm)  
Weight: 13 lbs

### ACCESSORIES

Travel Cover

78-6969-7777-2

### SERVICE PARTS

Foot  
Knob, Lamp Changer

78-8065-8117-5  
78-8065-8119-1

## 9000 SERIES OVERHEAD PROJECTORS

**9040 AJZ**  
**11.5" Open Singlet**  
 78-9236-6528-1  
 051125-59711-1

**9050 AJA**  
**11.5" Open Singlet**  
 78-9236-5693-4  
 051125-58302-2

**9060 AJE**  
**14" Clsd. Doublet**  
 78-9236-5695-9  
 051125-58304-6

**9070 AJF**  
**11.5" Clsd. Singlet**  
 78-9236-5696-7  
 051125-58305-3

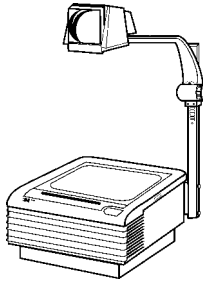

**9075 AJG**  
**11.5" Clsd. Singlet**  
 78-9236-6164-5  
 051125-58671-9

**9080 AJD**  
**11.5" Clsd. Singlet**  
 78-9236-5679-3  
 051125-58288-9

**9085 AGW**  
**11.5" Clsd. Singlet**  
 78-9236-6292-4  
 051125-58890-4

**9100 AJB**  
**14" Clsd. Doublet**  
 78-9236-5666-0  
 051125-58275-9

FEATURES	9040	9050	9060	9070	9075	9080	9085	9100
Average Lumens	2200	2500	2500	2500	4000	2500	4000	2800
Articulating Head			■	■	■	■	■	■
Lamp Life (Avg)	130	130	130	130	35/75	130	35/75	65/130
Lamp Changer						■	■	■
High/Low Switch					■		■	■
Color Tuning						■	■	■
Fold Down Post		■	■	■	■	■	■	■
Cord Wrap			■	■	■	■	■	■
Quiet Fan (<39 db)	■	■	■	■	■	■	■	■
Lamps Included	1	1	1	1	1	1	1	1
Warranty (Years)	5	5	5	5	5	5	5	5
Cool Stage (115°F)		■	■	■	■	■	■	■
Stage Aperture	10.5"	10.5"	10.5"	10.5"	10.5"	10.5"	10.5"	10.5"

SPECIFICATIONS	9040	9050	9060	9070	9075	9080	9085	9100
Width (in.)	16.25	16.25	16.25	16.25	16.25	16.25	16.25	16.25
Width - Post Down (in.)		17	17	17	17	17	17	17
Depth (in.)	16.5	16.5	16.5	16.5	16.5	16.5	16.5	16.5
Depth - Post Down (in.)		26	24	24	24	24	24	24
Height-Base (in.)	8.5	8.5	8.5	8.5	8.5	8.5	8.5	8.5
Height-Post Down (in.)		10	9.5	10	10	10	10	10
Height-Total (in.)	28	28	28	28	28	28	28	28
Weight (lbs.)	18	18	18	18	18	18.5	18.5	18.5
Power Cord (3-Wire)	10'	15'	15'	15'	15'	15'	15'	15'

### ACCESSORIES

AF4310	Roller Film 10 1/4 x 50	78-9020-1282-8	051125-07237-3
HA6000	Lamp, ENX 82V,360W	78-6969-7828-3	051125-58012-0
HA5760	Roller Attachment	78-6969-7214-6	051125-07141-3
HA5781	Carrying Handle	78-6969-7968-7	051125-58341-1
HA5785	Travel Cover	78-6969-7969-5	051125-58342-8
HA5792	Dust Cover	78-6969-7216-1	051125-07147-5

OVERHEAD PROJECTORS



## 9000 SERIES OVERHEAD PROJECTORS

<b>SERVICE PARTS</b>		9040	9050	9060	9070	9075	9080	9085	9100
<b>Mechanical:</b>									
Foot	26-1008-5211-5	■	■	■	■	■	■	■	■
Focus Knob	78-8064-1601-8	■	■	■	■	■	■	■	■
<b>Optical:</b>									
Head Mirror Assembly	78-8057-4230-7	■	■						
Head Mirror Assembly	78-8064-1457-5			■	■	■	■	■	■
Singlet Lens 11.5"	78-8014-8951-5	■	■		■		■		
Singlet Lens 11.5"	78-8073-2980-6					■		■	
Entrance Lens 14"	78-8011-1440-2			■					■
Exit Lens 14"	78-8014-8812-9			■					■
Exit Glass	78-8064-1650-5				■		■		
Exit Glass	78-8073-2982-2					■		■	
<b>Electrical:</b>									
Socket, Lamp (Single)	78-8079-8820-5	■	■	■	■	■			
Socket, Lamp (Dual)	78-8073-3017-6						■	■	■

## 9200 OVERHEAD PROJECTOR

**9200 AJC**  
**13.5" Open Triplet**  
 78-9236-5654-6  
 051125-58263-6

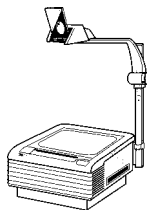

### FEATURES

3500 Average Lumens  
 50/100 (hi/low) Lamp Life (Avg)  
 Lamp Changer  
 High/Low Switch  
 Color Tuning  
 Carrying Handle  
 Fold Down Post  
 Cord Wrap  
 Quiet Fan (<39 db)  
 2 Lamps Included  
 5 Year Warranty  
 Cool Stage (115°F)  
 10.5" Stage Aperture

### SPECIFICATIONS

Width: 16.25"  
 Width - Post Down: 16.75"  
 Depth: 16.5"  
 Depth - Post Down: 26"  
 Height-Base: 8.5"  
 Height-Base-Post Down: 9.5"  
 Height-Total: 28"  
 Weight: 19 lbs.  
 Power Cord (3-Wire): 15'

### ACCESSORIES

AF4310	Roller Film 10 1/4 x 50	78-9020-1282-8	051125-07237-3
HA6000	Lamp, ENX 82V,360W	78-6969-7828-3	051125-58012-0
HA5760	Roller Attachment	78-6969-7214-6	051125-07141-3
HA5781	Carrying Handle	78-6969-7968-7	051125-58341-1
HA5785	Travel Cover	78-6969-7969-5	051125-58342-8
HA5792	Dust Cover	78-6969-7216-1	051125-07147-5

### SERVICE PARTS

<b>Mechanical:</b>	
Foot	26-1008-5211-5
Focus Knob	78-8064-1601-8
<b>Optical:</b>	
Head Mirror Assembly	78-8079-9156-3
Triplet Lens 13.5"	78-8097-3693-3
Socket, Lamp (Dual)	78-8073-3017-6

# 9550 OVERHEAD PROJECTOR

## 9550 AJH

Open Varifocal 280-315mm

78-9236-5642-1

051125-58251-3

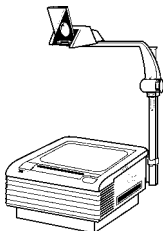

### FEATURES

4000 Average Lumens  
Lamp Changer  
Lamp Indicator  
High/Low Switch  
Carrying Handle  
Quiet Fan (<39 db)  
2 Lamps Included  
5 Year Warranty

### SPECIFICATIONS

**Optical:**  
Stage Aperture: 11.2"  
**Dimensions:**  
Width: 16.25"  
Width - Post Down: 16.75"  
Depth: 16.5"  
Depth - Post Down: 26"  
Height - Base: 8.5"  
Height - Base - Post Down: 9.5"  
Height - Total: 28"  
Weight: 29 lbs.  
Power Cord (3-Wire): 15'

### SERVICE PARTS

Foot	26-1008-5211-5
Head Mirror Assembly	78-8079-9227-2
Varifocal Lens (New)	78-8073-3296-6
Condenser Lens	78-8079-9025-0
Socket,Lamp (Dual)	78-8073-3015-0

OVERHEAD PROJECTORS

# 9700 OVERHEAD PROJECTOR

## 9700 AJJ

**Portable Transmissive**  
**Open Triplet 13.5" (342mm)**  
**Projection Lens**  
78-9236-5879-9  
051125-58459-3

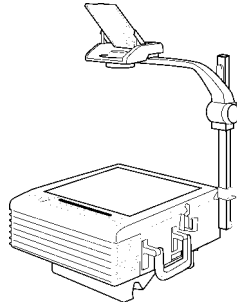

### FEATURES

4300 Average Lumens  
35/75 (hi/low) Lamp Life Average (Hrs.)  
Two A/C Outlets (equipped with Circuit Breaker)  
High/Low Lamp  
Hard-Shell Travel Cover  
Lamp Changer and Two Lamps  
External Color Tuning  
Stage Aperture 11.25" x 11.25"

### SPECIFICATIONS

#### Physical:

Width - Includes post and Focus Knob: 14.2"  
Depth: 16.75"  
Length - Includes Travel Cover: 21.2"  
Height - Top of head - machine set up: 28.0"  
Height - Folded - top of stage: 6.0"  
Height - Folded - includes top end of post: 7.5"  
Height - Top of stage - machine set up: 9.0"  
Weight - Includes Travel Cover: 21.8 lbs.  
Weight - Travel Cover only: 2.2 lbs.

#### Carton Dimensions:

Depth: 16.8"  
Width: 20"  
Length: 24.6"  
Weight: 28.6 lbs.

### ACCESSORIES

HA5705	Soft Bag	78-6969-8053-7	051125-58548-4
HA5706	Magnifier	78-6969-8054-5	051125-58549-1
HA5792	Dust Cover	78-6969-7216-1	051125-07147-5

**Note:** The 9700 does not accommodate Roller Attachments.

### SERVICE PARTS

#### Mechanical:

Foot-Base	78-8095-8318-6
Foot-Side	78-8095-8256-8
Focus Knob	78-8064-1601-8
Latch, Top Cover	78-8079-8768-6
Travel Cover	78-8095-8240-2
Handle	78-8095-8247-7

#### Optical:

Head Mirror Assembly	78-8095-8356-6
Triplet Lens 13.5"	78-8097-3694-1

# 9800 OVERHEAD PROJECTOR

**9800 AJK**  
**High Lumen**  
**Open Triplet 13.5" (342mm)**  
**Projection Lens**  
78-9236-5894-8  
051125-58474-6

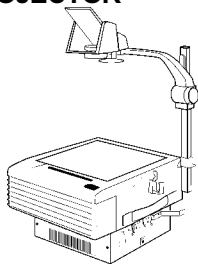

## FEATURES

6000 Average Lumens on High Setting (4200 on Low Setting)  
Lamp Life (Average) High - 20-30 hrs  
Flip-In Magnifier  
Two A/C Outlets (equipped with Circuit Breaker)  
11.25" x 11.25" Stage Size  
High/Low Lamp Switch  
Built-In Lamp Protector  
Second Lamp Indicator  
Lamp Changer and Two Lamps  
External Color Tuning  
15 Ft. - 3 Wire, Grounded Power Cord  
Stage Aperture - 11.25" x 11.25"

## SPECIFICATIONS

### Physical:

Width: 14.2" (361mm) (With Post Down: 17")  
Depth: 16.75" (425mm) (With Post Down: 25")  
Height: 29" (737mm) (top of head, machine set up)  
Height - With Post Down: 11"  
Weight: 29 lbs. (13.2 kg)

### Carton Dimensions:

Depth: 15.25"  
Width: 19.63"  
Length: 29.13"  
Weight: 37.4 lbs.

## SERVICE PARTS

### Optical:

Head Mirror Assembly	78-8079-9227-2
Lens, Flip-In Magnifier	78-8097-3522-4
Lens, Triplet 13.5"	78-8097-3694-1

OVERHEAD PROJECTORS

# ROLLER ATTACHMENTS

## 900/9000/4400/1700 SERIES OHP

HA5760 78-6969-7214-6 00-51125-07141-3

Roll Film is listed  
on Misc. Film page

\*10 to be used when the 2nd  
bracket is used for a front to  
back installation

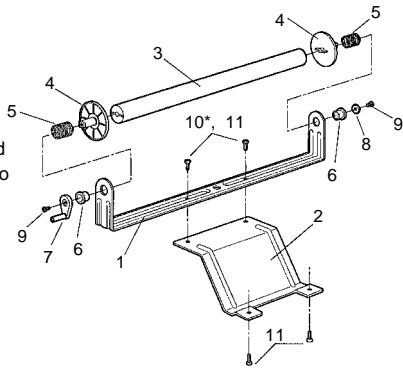

### Parts List: Item No.











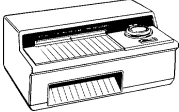

78-8064-1794-1	1	Bracket - Roller 10 1/4"	2 each
78-8064-1807-1	1	Bracket - Roller 11 1/4"	2 each
78-8064-1582-0	2	Brace - Roller	2 each
78-8052-8348-4	3	Take-Up Roll 10 1/4"	1 each
78-8052-8347-6	3	Take-Up Roll 11 1/4"	1 each
78-8064-1801-4	4	Driver Spindle	4 each
78-8015-2206-7	5	Spring	4 each
78-8161-4222-4	6	Bearing	4 each
78-8064-1802-2	7	Crank-Roller Attachment	2 each
12-7991-1737-4	8	No. 8 Plain Washer - Zinc Plate	2 each
26-1002-5091-4	9	Screw, 6-32 x 1/4L Taptite Pan HD Phillips	4 each
26-1007-5427-9	10*	Screw, 6-19 x 3/8L Plastite Pan HD Phillips	2 each
26-1005-7800-9	11	Screws, Metric THD Form Pan HD Phillips M-3.5 x 0.6 x 8 Long, Stl., Zinc Plate, Taptite	8 each

A4 Size Roller Attachment Kit - 78-6969-7455-5 (N/A in U.S.)

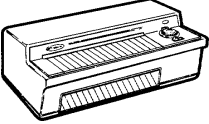
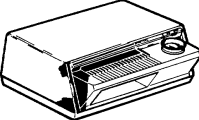
# HISTORY OF 3M INFRARED TRANSPARENCY

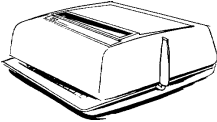
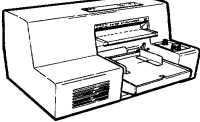
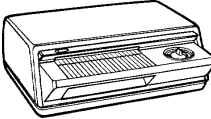
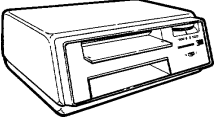
Dates are approximate

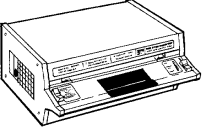
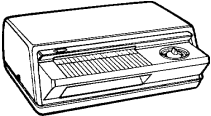
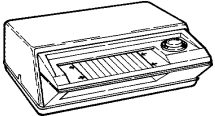
## MAKERS

<p><b>1952-1954</b> Model 12</p> 	<p><b>1955-1957</b> Model 17 "The Secretary"</p> 
<p><b>1956-1961</b> Model 19 "The Premier"</p> 	<p><b>1956-1961</b> Model 20 "The Fourteen"</p> 
<p><b>1957-1961</b> Model 22 "The Secretary"</p> 	<p><b>1960-1962</b> Model 44 "The Secretary"</p> 
<p><b>1960-1962</b> Model 270 "The Courier"</p> 	<p><b>1961-1970</b> Model 50 "The Major"</p> 
<p><b>1962-1963</b> Model 45A <b>1963 - 1964</b> Model 45B</p> 	<p><b>1962-1977</b> Model 47</p> 
<p><b>1963-1964</b> Model 86</p> 	<p><b>1963-1965</b> Model 31 "Encore Automatic"</p> 
<p><b>1964-1969</b> Model 45C <b>1969-1975</b> Model 45D</p> 	<p><b>1965-1969</b> Model 96</p> 
<p><b>1970-1975</b> Model 578</p> 	<p><b>1975-1979</b> Model 585 <b>1976-1979</b> Model 385</p> 
<p><b>1975-1977</b> Model 45E <b>1977-1980</b> Model 45F</p> 	<p><b>1980-1986</b> Model 4500</p> 
<p><b>1986 - 1999</b> Model 4550</p> 	

HISTORY OF 3M INFRARED TRANSPARENCY MAKERS

## 4550 TRANSPARENCY MAKER

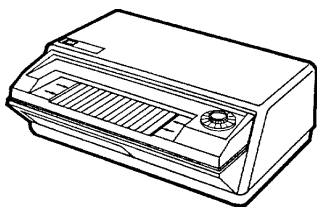

### 4550 AGA

78-9236-3515-1

051125-01191-4

### FEATURES

Produces Excellent:  
Transparencies  
Spirit Masters  
UL & CSA Approved  
Post Cool Thermostat  
Overheat Thermostat  
Safety Interlock  
Jam Switch  
Solid State Exposure Control  
Manufactured in USA  
One year warranty

### SPECIFICATIONS

<b>Power</b>	115 VAC, 60 Hz, 12.0 A
<b>Power Cord</b>	8 Ft, (2.5 m) 3 wire, US Plug
<b>Lamp</b>	1350W, 115V, Pre-focused
<b>Physical</b>	Width: 19 3/4" (50.2 cm)
	Depth: 16 1/2" (41.9 cm)
	Height: 7 1/2" (19.1 cm)
	Weight: 27 lbs. (12.25 kg)

### ACCESSORIES (Order from the Parts Department.)







Copy Belt - 9 3/8"	78-8990-4657-3
Dust Cover	78-9020-0119-3
Lamp 115 VAC - Model 4550 and 45	78-8003-6577-3

**Note:** The copy belt for the 4550 also fits the 45.  
The 4500 copy belt is no longer available.

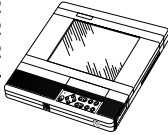
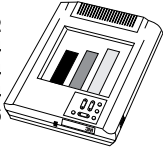
See the M4550 Service Manual for complete servicing instructions and list of service parts:

# HISTORY OF 3M EPS PRODUCTS

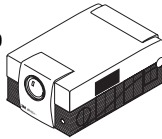
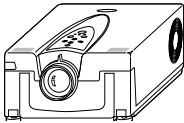
Dates are approximate

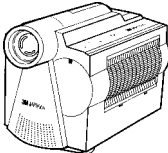
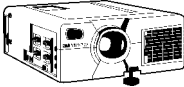
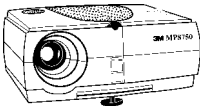
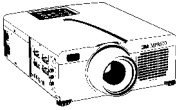
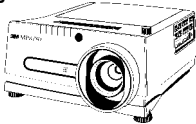
<p>2020 1987-1992                      2024 1988-1992                      2035 1989-1992                      2080A/B/C 1989-1994</p> 	<p>4080 1990-1991                      4180 1991-1992                      4100A/B 1992-1994                      4800 1992-1994                      4801 1992-1994                      4850 1994-1996</p> 
<p>5150 1994-1995                      5300 1993-1994                      5450 1994-1995                      5800 1992-1993                      5900 1993-1994</p> 	<p>6050 1997-1998                      6100 1996-1998                      6150 1994-1996                      6400 1996-1998                      6450 1994-1996                      6650 1996-1998                      6750 1996-1998</p> 
<p>8020 1995-1996                      300 lumens                      8030 1996-1998                      500 lumens</p> 	<p>8610 1998-P                      500 lumens                      8620 1997-1999                      400 lumens</p> 
<p>8625 1998-1999                      700 lumens</p> 	<p>8630 1997-1997                      500 lumens                      8640 1997-1999                      600 lumens                      8730 1998-1999                      550 lumens                      8740 1999-1999                      1100 lumens</p> 
<p>8650 1996-1998                      1000 lumens                      8660 1998-1999                      1100 lumens</p> 	<p>8635 1999-P                      900 lumens                      8725 1999-P                      700 lumens</p> 
<p>8750 1999-P                      1500 lumens</p> 	<p>8670 1999-P                      1700 lumens                      8745 1999-P                      1400 lumens</p> 
<p>8780 1999-P                      2300 lumens</p> 	

HISTORY OF 3M EPS PRODUCTS



## EPS PROJECTOR-TO-SCREEN DISTANCES

Electronically projected images are measured diagonally. Standard screen sizes are measured by the length and width. Use the following table to determine the diagonal measurement of a standard screen.

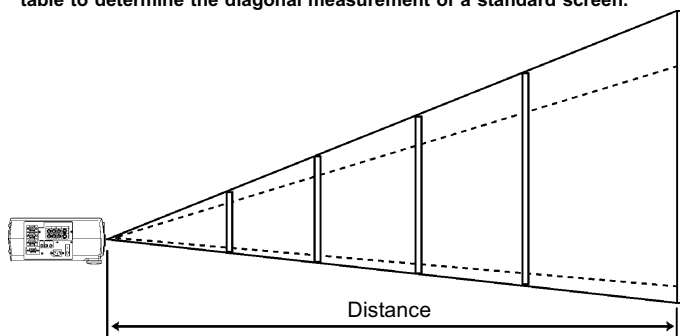

<b>MP8610/20 Multimedia Projector Projector-to-Screen Distances</b>			
<b>Distance to Screen (feet)</b>	<b>Diagonal (inches)</b>	<b>Width (inches)</b>	<b>Height (inches)</b>
4.5	54	43	32
5	60	48	36
6.5	79	63	47
8	100	80	60
10	128	102	77
12	154	123	92

<b>MP8625/8635/8645/8670/8725 Multimedia Projector Projector-to-Screen Distances</b>			
<b>Distance to Screen (feet)</b>	<b>Diagonal (inches)</b>	<b>Width (inches)</b>	<b>Height (inches)</b>
7	40-51	32-41	24-31
10.2	60-75	48-60	36-45
13.4	80-99	64-79	48-59
16.6	100-124	80-99	60-74
32.6	200-245	160-196	120-147

## EPS PROJECTOR-TO-SCREEN DISTANCES

<b>MP8750 Multimedia Projector Projector-to-Screen Distances</b>						
Distance to Screen (feet)	Maximum (f=25mm)			Minimum (f=45mm)		
	Image Width inches	Image Height inches	Max Height inches	Image Width inches	Image Height inches	Max Height inches
6.56	56	41.7	16.9	31.5	23.6	9.5
8.2	69.3	52	21.3	39	29.1	11.8
9.87	83.1	61.8	25.2	46.5	35	14.2
16.4	137	102.4	41.7	77.2	57.9	23.6
22.97	191	142.5	57.9	107.5	80.71	32.7
32.81	271.7	203.2	82.7	152.8	115	46.5

<b>MP8780 Multimedia Projector Projector-to-Screen Distances</b>			
Distance to Screen (feet)	Diagonal (inches)	Width (inches)	Height (inches)
4.7-7.4	40	32	24
7.4-11.4	60	48	36
10-15.3	80	64	48
12.7-19.3	100	80	60
15.3-23.3	120	96	72
19.3-29.2	150	120	90
25.8-39.1	200	160	120
39-58.9	300	287	180

<b>EP1840 Object Display Camera Image Capture Sizes</b> (all measurements are in inches)			
Distance from Document	Image Width Projected	Image Height Projected	Size of Readable Font
20	11.5	8.625	20
18	10.5	7.75	18
16	9.125	7	18
14	8.125	6	16
12	7	5.25	14
10	6	4.5	10
8	4.875	3.75	10

EPS PROJECT-TO-SCREEN DISTANCES

## ELECTRONIC PRESENTATION SYSTEMS

### EP1840 Object Display Camera

120 VAC 60Hz  
78-6969-8578-3  
051125-59265-9

### EP1990 Object Display Camera

220 VAC 50Hz  
78-6969-8724-3  
051125-59301-4

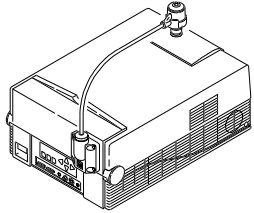

*Object Display Camera mounted on MP8610*

#### Basic Features:

- Focus from .25" (6 mm) to infinity
- Flexible gooseneck provides precise camera positioning
- Integrated microphone
- Compatible with MP8610, MP8625, MP8635, MP8670, MP8745 and MP8780 multimedia projectors

#### Unit Includes:

- Power supply
- Pigtail adapter
- Adapter bracket for MP8625

#### Technical Specifications:

**Resolution:** Horizontal (NTSC): 310 TV Lines  
Vertical (NTSC): 280 TV Lines  
Effective Pixels (NTSC): 250K

**Warranty:** Two year limited warranty on parts and labor

### DC1000 Object Display Camera

78-9236-6499-5  
051125-59528-5

#### Basic Features:

- 16x powered zoom and auto focus
- Rotating and telescoping head
- Integrated microphone
- Automatic compensation for back light
- Automatic white balance
- Auto exposure shutter

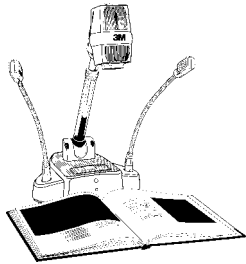

#### Unit Includes:

- Power supply
- Close-up lens
- Multi-media cable
- 2 Illumaflex lights

#### Technical Specifications:

**Resolution:** Horizontal: 450 TV Lines

**Warranty:** One year limited warranty on parts and labor

# ELECTRONIC PRESENTATION SYSTEMS

## MP8610 Multimedia Projector

78-9236-6432-6

051125-59255-0

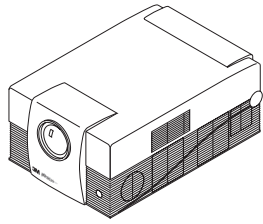

### Basic Features:

- 400W metal halide projection lamp
- SVGA native (800 x 600) resolution
- XGA (1024 x 768) compression
- VGA (640 x 480) expansion
- Fixed keystone correction
- Universal power supply
- Built-in serial, PS/2 and ADB mouse emulation

### Computer/Video Compatibility:

- IBM and compatibles - VGA, VESA (72 Hz, 75 Hz, 85 Hz, 56 Hz, 60 Hz, 43 Hz and 70 Hz)
- Apple Macintosh (II/LC/Quadra)
- NTSC, PAL, SECAM, S-VHS video

### Unit Includes:

- VGA video cable
- Mouse cable
- Power cord set (U.S., UK and Europe)
- PS/2 mouse adapter
- Audio Cable (RCA-mini jack)
- S-video cable
- RCA video cable
- Remote control

### Technical Specifications:

**Dimensions:**           Width:       11" (280 mm)  
                                  Height:     7" (178 mm)  
                                  Depth:     17.3" (440 mm)

**Weight:**                 13.4 lbs (6.0 kg)

**Warranty:**               Two year limited warranty on parts and labor

## ELECTRONIC PRESENTATION SYSTEMS

### MP8635B Multimedia Projector

78-9236-6532-3

051125-59740-1

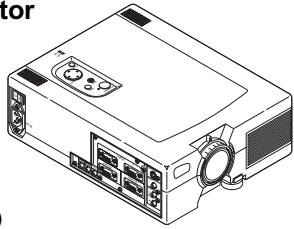

#### Basic Features:

- Ultra-high performance 150W projection lamp
- SVGA native resolution (800x600)
- 3 LCD panels
- Intelligent XGA and VGA scaling
- Serial, PS/2 and ADB mouse emulation
- 4x digital magnification
- Fixed keystone correction
- Universal power supply

#### Computer/Video Compatibility:

- IBM and compatible - XGA, SVGA, VGA, VESA 75Hz
- Apple Macintosh (II, LC, Quadra and Powerbook)  
*optional MAC cable required*
- Autosync: NTSC, PAL, SECAM, NTSC 4.43, M-PAL and N-PAL

#### Unit Includes:

- Power cord (110V - US, 220V - UK and Europe)
- 3-conductor video/audio cable
- VGA cable
- Remote control
- PS/2 cables

#### Technical Specifications:

**Dimensions:**           Width:       10.3" (257.5 mm)  
                                  Height:     4.3" (106 mm)  
                                  Depth:     13.4" (336 mm)

**Weight:**                 9.9 lbs (4.5 kg)

**Warranty:**              Two year limited warranty on parts and labor. Lamp: 90 days or 180 hours, whichever comes first. See warranty for details.

# ELECTRONIC PRESENTATION SYSTEMS

## MP8670 Multimedia Projector

78-9236-6497-9  
051125-59525-4

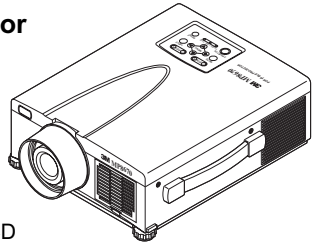

### Basic Features:

- UHB (Ultra-high bright) 190W projection lamp
- SVGA native resolution (three LCD panels are used for the R, G and B))
- Intelligent XGA (60 Hz and 75 Hz) and VGA scaling
- USB, Serial, PS/2 and ADB mouse emulation
- 4x digital magnification
- Digital keystone correction
- Picture-in-Picture
- Universal power supply
- Kensington security slot

### Computer/Video Compatibility:

- IBM and compatible - XGA, SVGA, VGA, VESA 75Hz
- Apple Macintosh (II, LC, Quadra and Powerbook)  
*optional MAC cable required*
- Autosync: NTSC, PAL, SECAM, NTSC 4.43, M-PAL and N-PAL

### Unit Includes:

- Power cord (US, UK and Europe)
- 3-conductor video/audio cable
- VGA cable
- Remote control
- S-Video cable (S-video mini DIN4-pin)
- PS/2, ADB and Serial mouse cables
- Stereo mini-jack
- Mac adapter

### Technical Specifications:

<b>Dimensions:</b>	Width:	11.5" (289 mm)
	Height:	5.0" (124 mm)
	Depth:	13.8" (345 mm)

**Weight:** 13.0 lbs (5.9 kg)

**Warranty:** Two year limited warranty on parts and labor. Lamp: 90 days or 180 hours, whichever comes first. See warranty for details.

## ELECTRONIC PRESENTATION SYSTEMS

### MP8725B Multimedia Projector

78-9236-6507-5

051125-59561-2

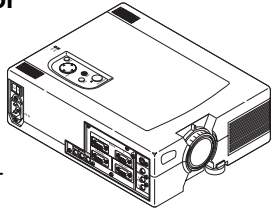

#### Basic Features:

- 700 ANSI lumens of brightness
- XGA native resolution (three .9" 1024 x 768 LCD panels are used for the R, G and B)
- Intelligent image scaling technology optimizes image quality
- Manual zoom and focus
- Digital image magnification up to 4 times
- Three input channels for connection of two computers and one video signal
- Virtual Mouse remote control with laser pointer
- Six presentation tools: blank, laser pointer, timer, reveal, mouse emulation and digital image magnification
- Kensington security slot
- Built-in stereo speakers

#### Computer/Video Compatibility:

- IBM and compatible - SXGA, XGA, SVGA, VGA
- Apple Macintosh (II, LC, Quadra, Power Macintosh and PowerBook)
- Autosync: NTSC, NTSC 4.43, PAL, PAL-M, PAL-N, SECAM

#### Unit Includes:

- RGB computer cable
- RCA video cable, S-VHS cable
- Serial and PS/2 mouse adapter
- Macintosh adapter
- Remote control with laser pointer
- Detachable power cords

#### Technical Specifications:

**Dimensions:** Width: 9.8" (248 mm)  
Height: 3.9" (100 mm)  
Depth: 13.1" (330 mm)

**Weight:** 9.8 lbs (4.4 kg)

**Warranty:** Two year limited warranty on parts and labor.  
Lamp: 90 days or 180 hours, whichever comes first. See warranty for details

## ELECTRONIC PRESENTATION SYSTEMS

### MP8745 Multimedia Projector

78-9236-6502-6

051125-59531-5

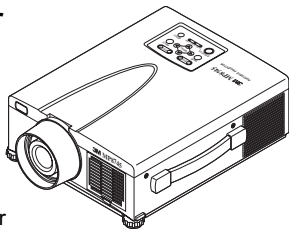

#### Basic Features:

- UHB (Ultra-high bright) 190W projection lamp
- XGA native resolution (three 1.3" 1024 x 768 LCD panels are used for the R, G and B)
- Intelligent XGA (60 Hz and 75 Hz) and VGA scaling
- USB, Serial, PS/2 and Apple Desktop Bus (ADB) mouse emulation
- One video input connection (composite and S-video compatible)
- Virtual Mouse remote control with power zoom and power focus tools
- 4x digital magnification
- Digital keystone correction
- Kensington security slot
- Picture-in-picture
- Universal power supply
- Two built-in stereo speakers

#### Computer/Video Compatibility:

- IBM and compatible - SXGA, XGA, SVGA, VGA
- Apple Macintosh (II, LC, Quadra and PowerBook)
- Autosync: NTSC, NTSC 4.43, PAL, PAL-M, PAL-N, SECAM
- Composite and S-VHS

#### Unit Includes:

- VGA cable
- Mac adapter
- PS/2, ADB and Serial mouse cables
- S-Video cable (S-Video mini DIN4-pin)
- 3-Conductor video/audio cable
- Remote control with laser pointer
- Detachable power cords
- Stereo mini-jack

#### Technical Specifications:

**Dimensions:** Width: 11.5" (289 mm)  
Height: 5.0" (124 mm)  
Depth: 13.8" (345 mm)

**Weight:** 13 lbs (5.9 kg)

**Warranty:** Two year limited warranty on parts and labor.  
Lamp: 90 days or 180 hours, whichever comes first. See warranty for details



## ELECTRONIC PRESENTATION SYSTEMS

### MP8750 Multimedia Projector

MP8750 - 78-9236-6435-9  
051125-59258-1

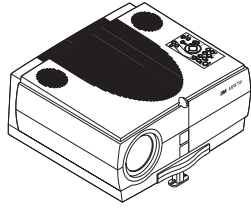

#### Basic Features:

- 1500 ANSI lumens of brightness
- XGA native (1024 x 768) resolution
- .9 DMD chip
- Intelligent image scaling technology optimizes image quality
- Power zoom and focus
- Two computer input connections each with a separate audio-in connection
- Three video/audio input connections
- Virtual Mouse remote control with power zoom, power focus, and presentation tools
- Four presentation tools: blank, timer, reveal, and mouse emulation
- Universal power supply
- Built-in surround sound system

#### Computer/Video Compatibility:

- IBM and compatible - SXGA, XGA, SVGA, VGA
- Apple Macintosh (II, LC, Quadra and PowerBook)
- NTSC, NTSC 4.43, PAL, PAL-M, PAL-N, SECAM, PAL-60
- Composite and S-VHS

#### Unit Includes:

- VGA cable
- RCA video/audio cable, S-VHS cable
- Serial and PS/2 mouse cables
- Remote control
- Detachable power cords
- Stereo mini-jack

#### Technical Specifications:

**Dimensions:** Width: 13" (331 mm)  
Height: 5.4" (137 mm)  
Depth: 10.7" (272 mm)

**Weight:** 17 lbs (7.6 kg)

**Warranty:** Two year limited warranty on parts and labor.  
Lamp: 90 days or 180 hours, whichever comes first. See warranty for details

## ELECTRONIC PRESENTATION SYSTEMS

### MP8780 Multimedia Projector

**MP8780** - 78-9236-6493-8  
051125-59456-1

**MP8780L** - 78-9236-6509-1  
051125-59563-6

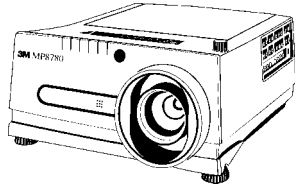

#### Basic Features:

- Ultra-high brightness 440W projection lamp
- Native XGA (1.8 inch XGA HTPS LCD panels with high aperture ratio)
- Intelligent scaling for UXGA, SXGA, SVGA and VGA
- Power zoom and focus
- Three computer inputs: RGB1, RGB2, RGB3 (BNC)
- Three video inputs: Video1, Video2, Video3
- Picture-in-picture video image
- Plug-and-play
- High resolution and component video compatible
- Higher resolution for video by de-interlacing
- Horizontal and vertical image inverting
- Horizontal and vertical image position control

#### Computer/Video Compatibility:

- IBM and compatible - UXGA, SXGA, XGA, SVGA, VGA
- Apple Macintosh (II, LC, Quadra and PowerBook)
- NTSC, NTSC 4.43, PAL, PAL-M, PAL-N, SECAM, PAL-60
- Composite and S-VHS

#### Unit Includes:

- VGA cable
- RCA to stereo mini jack
- Serial, ADB and PS/2 mouse cables
- Remote control
- 3-conductor video/audio cable
- Video cable (S-Video mini DIN4-pin)
- Detachable power cords
- MAC adapter

#### Technical Specifications:

**Dimensions:** Width: 17.2" (430 mm)  
Height: 8.9" (222 mm)  
Depth: 19.8" (495 mm)

**Weight:** 35 lbs (16.0 kg)

**Warranty:** Two year limited warranty on parts and labor.  
Lamp: 12 months or 1000 hours, whichever comes first. See warranty for details

# ELECTRONIC PRESENTATION SYSTEMS

## Optional Accessories

### MP8030 Multimedia Projector Accessories

<u>Description</u>	<u>3M Part Number</u>
Ceiling Mount Bracket	78-6969-8310-1
Soft Travel Case	78-6969-8130-3
Suspension Post	78-6969-8312-7
VGA Extension Cable - 2.5m	XX-0034-1131-9

### MP8610/20 Multimedia Projector Accessories

<u>Description</u>	<u>3M Part Number</u>
Mac Cable Set (8610/20)	DY-0205-1361-9
Mac Cable Set 8620, optional (8620)	DY-0205-1361-9
Carry Case (8610)	78-6969-8579-1
Shipping Case (8610)	78-6969-8580-9
Monitor Splitter Box Kit (8610)	78-6969-8597-3
Extension Cable Kit (8610)	78-6969-8582-5
Stereo Mini-Jack (8610)	78-8118-8290-7
Ceiling Mount Kit (8610)	78-6969-8581-7
Notebook/Deluxe Carry Case (8620)	78-6969-8423-2
Shipping Case (8620)	78-6969-8450-5
Document Camera— 120VAC 60 Hz (8610/25/35/70)	78-6969-8578-3
Document Camera— 220VAC 50 Hz (8610/25/35/70)	78-6969-8724-3

### MP8625 Multimedia Projector Accessories

<u>Description</u>	<u>3M Part Number</u>
Ceiling Mount	78-6969-8748-2
Adjustable Height Suspension	78-6969-8312-7
Shipping Case	78-6969-8584-1
Soft Carry Case	78-6969-8585-8

### MP8635/8635B/8725/8725B Multimedia Projector Accessories

<u>Description</u>	<u>3M Part Number</u>
Ceiling Mount	78-6969-8781-3
Adjustable Height Suspension	78-6969-8312-7
Shipping Case	78-6969-8779-7
Soft Carry Case	78-6969-8780-5
Document Camera	78-6969-8578-3

# ELECTRONIC PRESENTATION SYSTEMS

## Optional Accessories (continued)

### MP8630/8640/8730/8740 Multimedia Projector Accessories

<u>Description</u>	<u>3M Part Number</u>
Ceiling Mount	78-6969-8357-2
Shipping Case	78-6969-8347-3
Soft Carry Case with shoulder strap	78-6969-8346-5
Soft Travel Case with wheels	78-6969-8130-3
Suspension Post	78-6969-8312-7

### MP8670/8745 Multimedia Projector Accessories

<u>Description</u>	<u>3M Part Number</u>
Ceiling Mount	78-6969-8924-9
Adjustable Height Suspension	78-6969-8312-7
Shipping Case	78-6969-8925-6
Soft Carry Case	78-6969-8926-4
Document Camera - 120 VAC 60 Hz	78-6969-8578-3
Document Camera - 220 VAC 50 Hz	78-6969-8724-3

### MP8750 Multimedia Projector Accessories

<u>Description</u>	<u>3M Part Number</u>
Soft Carry Case	78-6969-8587-4
Shipping Case	78-6969-8588-2
Ceiling Mount	78-6969-8591-6

### MP8780 Multimedia Projector Accessories

<u>Description</u>	<u>3M Part Number</u>
Shipping Case	78-6969-8955-3
Ceiling Mount	78-6969-8921-5
Adjustable Height Suspension	78-6969-8312-7

### Cameras

<u>Description</u>	<u>3M Part Number</u>
DC1000 Document Camera (all projectors)	78-9236-6499-5

# ELECTRONIC PRESENTATION SYSTEMS

## Customer Replaceable Parts

Order: 3M Service Parts Center in St. Paul or ESPC Hilden, Germany

### Remote Controls

<u>Description</u>	<u>3M Part Number</u>
4180	26-1010-1103-4
4850	78-8091-1439-6
4100B	78-8091-1442-0
6050	DY-0205-1265-2
6100, 6400, 6650, 6750	DY-0205-1056-5
6150, 6450	DY-0205-1005-2
8020	26-1011-3417-4
8030	26-1012-0238-5
8610	78-8118-3475-9
8620	DY-0205-1353-6
8625, 8725	78-8118-3534-3
8630	78-8118-3311-6
8635, 8725B	78-8118-8185-9
8640	78-8118-3364-5
8650	78-6969-8316-8
8660	78-8118-3395-9
8670, 8745	78-8118-8246-9
8730, 8740	78-8118-3402-3
8750, 8760	78-8118-7949-9
8780	78-8118-3649-9

### Power Cords

<u>Description</u>	<u>3M Part Number</u>
4850, US/Canada	78-8091-1436-2
6000, DC1000, EU - 6000	26-1009-7104-8
6000, DC1000, UK - 6000	26-1010-1051-5
6000, DC1000, US - 6000	26-1009-7103-0
all 8000, EU	DY-0205-1354-4
all 8000, UK	DY-0205-1355-1
all 8000, US	DY-0205-1356-9

### VGA Video Cables

<u>Description</u>	<u>3M Part Number</u>
Cable C454-6 90045406 (5000)	26-1009-7102-2
Cable, VGA 15-26 pins (4100, 4100B, 4800,4801, 4850)	78-8091-1402-4
Cable, VGA 15-15 pins (4080, 4180)	78-8091-1409-9
Cable, CGA/EGA 9-15 pins (4080, 4100B, 4180)	78-8091-1410-7
Cable, VGA 15-26 pins (6150A)	DY-0205-1002-9
Cable, VGA (6000, 8020, 8030, 8650, 8660)	78-8118-3246-4
Cable, VGA (w/DDC) (all 8000)	78-8118-3401-5

# ELECTRONIC PRESENTATION SYSTEMS

## Customer Replaceable Parts (continued)

### RGB Video Accessories

<u>Description</u>	<u>3M Part Number</u>
VGA-Cable, Splitterbox (all)	DY-0205-1521-8
Splitter/Booster Box (80MHz) (all)	78-6969-8597-3

### Mac Video Cables

<u>Description</u>	<u>3M Part Number</u>
Mac Cable (6000)	DY-0205-1049-0
Mac II Monitor Cable (6000)	DY-0205-1004-5
Mac II Video Cable (computer-LCD panel) (6150, 6450)	DY-0205-1003-7
Mac Monitor Cable (6750)	DY-0205-1050-8
Apple Mac II Video Adapter Cable (8030)	26-1011-3422-4

### Video Adapters, Mac

<u>Description</u>	<u>3M Part Number</u>
Mac II Adapter Plug Set (4100, 4100B, 4800, 4801, 4850)	78-8091-1403-2
Adapter, Mac (switchable) (all 8000)	78-8118-3308-2

### Cables/Adapters, Video

<u>Description</u>	<u>3M Part Number</u>
Cable, RCA (5000)	26-1010-1026-7
Video Cable, (RCA M/M) (all)	DY-0205-1008-6
Adapter, S-Video-Composite (DocCam)	78-8118-3490-8
Cable Assy (2m integrated) (DC1000)	78-8118-8391-3

### Cables, Audio/Video

<u>Description</u>	<u>3M Part Number</u>
Cable, 3 Cond. Audio/Video (all)	78-8118-3234-0
Cable, 3 Cond. Audio/Video (8635, 8670, 8745)	78-8118-3306-6

### Cables, S-Video

<u>Description</u>	<u>3M Part Number</u>
S-Video Cable (all models)	78-8118-3238-1

### Cables, Audio

<u>Description</u>	<u>3M Part Number</u>
Audio Cable (RCA M/M) (all)	DY-0205-1009-4
Audio Cable (RCA to 3.5mm) (all)	DY-0205-1359-3
Cable, Stereo Mini Jack w/Core (all)	78-8118-8290-7

# ELECTRONIC PRESENTATION SYSTEMS

## Customer Replaceable Parts (continued)

### Cables/Adapters, Mouse I/F

<u>Description</u>	<u>3M Part Number</u>
Mouse Y-cable, optional (all)	DY-0205-1507-7
Mouse Cable, Serial RS-232 (6000)	DY-0205-1007-8
PS/2 Mouse Adapter (6000)	DY-0205-1240-5
Cable, Mouse Extension (20M) (6000)	DY-0205-1232-2
Cable, PS/2 Mouse w/Core (8625, 8725, 8740, 8670)	78-8118-8105-7
Cable, ADB Mouse w/Core (8625, 8725, 8740, 8745)	78-8118-8106-5
Cable, Serial Mouse w/Core (8625, 8725, 8740)	78-8118-8107-3
Cable, Serial Mouse (8650)	78-8118-3243-1
Cable, Serial Mouse (8660, 8780)	78-8118-8377-2
Cable, PS/2 (Mouse Emulation) (8660, 8780)	78-8118-8378-0
Cable, ADB Mouse (8660, 8780)	78-8118-8379-8
Cable, USB Mouse (8670, 8745, 8780)	78-8118-8186-7

### Cables, RS-232 Control

<u>Description</u>	<u>3M Part Number</u>
Cable, RS-232 Control (8030)	26-1012-0632-9
Cable, RS-232 Control (all 8600/8700) (not 8620, 8610, 8650, 8660, 8780)	78-8118-3312-4
Cable, RS-232 Control (8650)	78-8118-3243-1
Cable, RS-232 Control (8660, 8780)	78-8118-8154-5

### Misc. Cables/Adapters

<u>Description</u>	<u>3M Part Number</u>
Cable, Mac Serial Port (2080B/5000)	26-1008-5219-8
Cable, Power Loop Through (4180)	26-1008-5245-3
Cable, Mac (4801B) (4800)	26-1009-3808-8
Scart-RCA Adapter (6000)	DY-0205-1011-0
PC Cable (6000)	DY-0205-1048-2
BNC Cable (6000)	DY-0205-1051-6
13 W3 Computer Cable (6000)	DY-0205-1052-4
13 W3 Monitor Cable (6000)	DY-0205-1053-2
BNC Adapter Set (5x) (6000)	DY-0205-1054-0
BNC Set (6000)	DY-0205-1055-7
Extended Serial Adapter (20m) (6000)	DY-0205-1238-9

### Misc. Hardware

<u>Description</u>	<u>3M Part Number</u>
AC Adapter CAA108 (2035)	26-1008-3102-8
AC Adapter CAA112 (2080)	26-1008-3107-7
AC Adapter CAA113 (2080)	26-1008-3109-3
120 V AC Adapter 520001100 (4000)	26-1009-3570-4
230 V AC Adapter 520001401 (4000)	26-1009-3571-2
120 V AC/12 V DC Power Supply (4000)	78-8091-1404-0
220 V AC/12 V DC Power Supply (4000)	78-8091-1405-7
AC Adapter, Universal (4850)	78-8091-1435-4

**ELECTRONIC PRESENTATION SYSTEMS**  
**Customer Replaceable Parts (continued)**  
**Misc. Hardware (continued)**

<u>Description</u>	<u>3M Part Number</u>
Glass Protection, Lower (5000)	26-1010-1034-1
Mac II Terminator, Non-Video (5000)	78-8091-1432-1
IBM Terminator, Non-Video (5000)	78-8091-1433-9
Disk, PC Remote v3.0, 3.5 (5450)	78-8091-1428-9
Disk, Remote Mac v2.0 (5450)	78-8091-1430-5
Lower Glass Plate (6000)	DY-0205-1013-6
AC Power Supply, 100-250 V AC, 50-60 Hz (6000)	DY-0205-1014-4
Lens Cover (8030)	26-1011-3418-2
Cover, Interface, Keypad (8620)	DY-0205-1415-3
Cover, Lamp Housing (8620)	DY-0205-1456-7
Swab, LCD Cleaning (8650)	78-8118-3302-5
Lens Cap (8650)	78-8118-3340-5
Lens Cap (8660)	78-8118-3396-7
Foot, Rubber (8650, 8660)	78-8118-3253-0
Macrolens, 2 Diopter (DC1000)	78-8118-8388-9
Door, Touchpad Cover (DC1000)	78-8118-8390-5
Universal Power Supply (DC1000)	78-8118-8389-7

**Air Filters**

<u>Description</u>	<u>3M Part Number</u>
Dust Filter (6000)	DY-0205-1030-0
Air Filter (8020)	26-1011-8837-8
Air Filter (8030)	26-1012-0657-6
Air Filter (included in lamp kit 78-6969-8577-5) (8610)	78-8118-3604-4
Filter, Cooling Fan (8620)	DY-0205-1360-1
Air Filter (8625)	78-8118-3512-9
Air Filter - B (8630)	78-8118-3275-3
Air Filter (8640)	78-8118-3648-1
Air Filter, Side (8650)	78-8118-3232-4
Air Filter, Side (8660)	78-8118-3439-5
Air Filter, Bottom (8650/60)	78-8118-3221-7
Air Filter (8635, 8725B)	78-8118-8270-9
Air Filter (8670, 8745)	78-8118-8211-3
Air Filter (8725)	78-8118-8119-8
Air Filter (8730)	78-8118-3469-2
Air Filter (8740)	78-8118-8171-9
Air Filter (8780)	78-8118-8357-4

**ELECTRONIC PRESENTATION SYSTEMS**



# ELECTRONIC PRESENTATION SYSTEMS

## Customer Replaceable Parts (continued)

### Air Filter Covers

<u>Description</u>	<u>3M Part Number</u>
8020, A	26-1011-8843-6
8030, B	26-1011-8844-4
8610	78-8118-3605-1
8620	DY-0205-1455-9

---

### Lamps

<u>Description</u>	<u>3M Part Number</u>
Lamp 250W (8020)	78-6969-8131-1
Lamp 260W (8030)	78-6969-8262-4
Projection Lamp Kit (400W Metal Halide Lamp, Air Filter) (8610)	78-6969-8577-5
Lamp 400W (8620)	78-6969-8424-0
Lamp 150W (8625)	78-6969-8583-3
Lamp 250W (8630)	78-6969-8329-1
Ultra-High Brightness Lamp Module, 150W (8635, 8725B)	78-6969-8920-7
Lamp 260W (8640, 8730)	78-6969-8461-2
Lamp 350W Phase 1 & 2 (8650)	78-6969-8306-9
Lamp 350W Phase 3 (8650)	78-6969-8422-4
Lamp 350W (8660)	78-6969-8460-4
Ultra-High Performance Lamp Module, 120W (8725)	78-6969-8778-9
Lamp Module, 260W (8740)	78-6969-8782-1
Ultra-High Performance Lamp Module, 190W (8670, 8745)	78-6969-8919-9
Lamp, 350W Metal Halide w/ Air Filter (8750)	78-6969-8586-6
Lamp, 440W Metal Halide (8780)	78-6969-8958-7
Lamp, Flex Light (DC1000)	78-8118-8386-3

## TRANSPARENCY FILM FOR COPIERS

	<p><b>REMOVABLE STRIPE</b>                  Water-Based Coating - 99% Solvent-Free                  8-1/2" x 11" (215mm x 279mm)</p>			
Product Number	Film Color	Sheets/Box Box/Ctn	Stock Number	UPC Number
PP2200	Clear	100/5	78-6969-6992-8	051125-01800-5

	<p><b>PAPER BACKED</b>                  Water-Based Coating - 99% Solvent-Free                  8-1/2" x 11" (215mm x 279mm)</p>			
Product Number	Film Color	Sheets/Box Box/Ctn	Stock Number	UPC Number
PP2410	Clear	100/5	78-6969-7010-8	051125-01808-1

	<p><b>UNIVERSAL - NO STRIPE</b>                  Water-Based Coating - 99% Solvent-Free                  8-1/2" x 11" (215mm x 279mm)</p>			
Product Number	Film Color	Sheets/Box Box/Ctn	Stock Number	UPC Number
PP2500	Clear	100/5	78-6969-7011-6	051125-01810-4
PP2500/20	Clear	20/20	78-6969-8562-7	051125-07361-5
PP2500/35	Clear	50/5	78-6969-8537-9	051125-59234-5

	<p><b>COLOR LASER COPIER FILM -                  REMOVABLE SIDE STRIPE</b>                  8-1/2" x 11" (215mm x 279mm)</p>			
Product Number	Film Color	Sheets/Box Box/Ctn	Stock Number	UPC Number
PP2260	Clear	50/5	78-6969-7480-3	051125-07401-8
CG2000	Clear	50/5	78-6969-8352-3	051125-58924-6

TRANSPARENCY FILM FOR COPIERS

## TRANSPARENCY FILM FOR COPIERS

	<b>HIGHER TEMPERATURE COPIERS AND LASER PRINTERS</b> <b>Water-Based Coating - 99% Solvent-Free</b> 8-1/2" x 11" (215mm x 279mm)			
Product Number	Film Color	Sheets/Box Box/Ctn	Stock Number	UPC Number
PP2950	Clear	100/5	78-6969-7028-0	051125-01818-0
CG5000	Clear	50/5	78-6969-8241-8	051125-58774-7
CG5000/20	Clear	20/10	78-6969-8240-0	051125-58773-0

<b>HIGHLAND BRAND ECONOMY</b>  8-1/2" x 11" (215mm x 279mm)																			
<table border="1" style="margin: auto; border-collapse: collapse;"> <tr> <td style="padding: 2px;">901</td> <td style="padding: 2px;">No Stripe</td> <td style="padding: 2px;"></td> </tr> <tr> <td style="padding: 2px;">902</td> <td style="padding: 2px;">Stripe (Printed)</td> <td style="padding: 2px;">On 11" Side</td> </tr> <tr> <td style="padding: 2px;">903</td> <td style="padding: 2px;">Removable Stripe</td> <td style="padding: 2px;">On 11" Side</td> </tr> <tr> <td style="padding: 2px;">904</td> <td style="padding: 2px;">Paper Backed</td> <td style="padding: 2px;">Attached on the 11" Side</td> </tr> <tr> <td style="padding: 2px;">905</td> <td style="padding: 2px;">No Stripe</td> <td style="padding: 2px;">For High Temp. Copiers</td> </tr> </table>					901	No Stripe		902	Stripe (Printed)	On 11" Side	903	Removable Stripe	On 11" Side	904	Paper Backed	Attached on the 11" Side	905	No Stripe	For High Temp. Copiers
901	No Stripe																		
902	Stripe (Printed)	On 11" Side																	
903	Removable Stripe	On 11" Side																	
904	Paper Backed	Attached on the 11" Side																	
905	No Stripe	For High Temp. Copiers																	
Product Number	Film Color	Sheets/Box Box/Ctn	Stock Number	UPC Number															
901	Clear	100/5	78-6969-8594-0	051125-07327-1															
902	Clear	100/5	78-6969-8592-4	051125-07328-8															
903	Clear	100/5	78-6969-8595-7	051125-57490-7															
904	Clear	100/5	78-6969-8570-0	051125-57489-1															
905	Clear	100/5	78-6969-8456-2	051125-89047-1															

## INFRARED (IR) TRANSPARENCY FILM

(For use with Model 4550 & Other IR Transparency Makers)

<b>3M BRAND INFRARED TRANSPARENCY FILM</b> <b>Black Image on a Clear Background</b> 8-1/2" x 10-1/2" (215mm x 266mm)					
Product Number	Film Color	Mil	Sheets/Box Box/Ctn	Stock Number	UPC Number
IR1140	Clear	4.0	100/5	78-6969-8448-9	051125-01740-4

## COLOR COPIER TRANSPARENCY FILM

### Color Laser Printer/Copier Film For Color Laser Printers/Copiers Only

8-1/2" x 11" (215mm x 279mm)

CG2000 has a removable stripe on the 11" side

CG3710 has a removable stripe on the 8-1/2" side

Product Number	Color	Sheets/Bx Box/Ctn	Stock #	UPC #
CG2000	Clear	50/5	78-6969-8352-3	051125-58924-6
CG3700*	Clear	50/5	78-6969-8432-2	051125-58657-3
CG3710	Clear	50/5	78-6969-8431-5	051125-58627-6
CG5000	Clear	50/5	78-6969-8241-8	051125-58774-7
CG5000/20	Clear	20/10	78-6969-8240-0	051125-58773-0
PP2260	Clear	50/5	78-6969-7480-3	051125-07401-8

\* Water-Based Coating - 99% Solvent-Free

## COLOR COPIER GUIDE

■ - Recommended Film

□ - Alternate Film

3M Transparency Film

COLOR COPIER TRANSPARENCY FILM

Color Copiers	PP2200	PP2260	PP2500	PP2950	CG2000	CG3710	CG5000
<b>Canon Color Copiers</b>							
CLC 200, 300, 320, 350, 500, 550	□	■				■	
CLC 700, 800, 900, 950, 1120, 1150	□				■		
CLC 1000, 2400	□	■				■	
<b>Danka</b>							
C1600, 1650	□				■		
C2000	□	■				■	
<b>Gestetner</b>							
CS210/210E, 206/206E, 2606/2606E, 2703/2703E	□	■	□	□		■	□
<b>Hewlett-Packard</b>							
110, 120, 140, 145 (use CG3460 or CG3480)							
150, 155, 160, 170 (use CG3460 or CG3480)							
210, 260, 270 (use CG3460 or CG3480)							

The image quality of the recommended product is superior to the alternate when projected.

## COLOR COPIER GUIDE

■ - Recommended Film

□ - Alternate Film

3M Transparency Film

Color Copier	PP2200	PP2260	PP2410	PP2500	PP2950	CG2000	CG5000
<b>Kodak</b>							
Coloredge 1525+, 1550+	□	■				■	
1560, 1565	□				■		
<b>Konica</b>							
7720, 7823, 9028	□	■				■	
<b>Lanier</b>							
5506DC, 5603DC, 5606DC, 5706, 5806, 5710-5710E	□	■		□	□	■	□
<b>Minolta</b>							
CF80, CF80Plus, DI620, 900, 910	□	■		□		■	□
<b>Mita</b>							
PointSource CI-7500, 7600, 9500	□	■		□		■	□
<b>OCE</b>							
CS90, 95	□				■		
CS150, 200	□	■				■	
<b>Pitney Bowes</b>							
CD-6000, 6100	□	■		□		■	■
<b>Ricoh</b>							
Aficio Color 2003, 2103, 2203, 3006, 4106, 5006, 5106, 5206, 6010, 6110	□	■		□		■	□
<b>Savin</b>							
SC106, SDC103, 206, 306, 410/410E	□	■	□	□		■	□
<b>Sharp</b>							
AR-C860, 861, 862	□	■		□		■	□
<b>Toshiba</b>							
FC70	□	■		□		■	□
<b>Xerox</b>							
DocuColor 4LP, 12, 30, 40, Office 6	□	■					
Document Centre Color Series 50	□	■					
5750, 5760, 5765, 5790, 5799	□	■				■	

The image quality of the recommended product is superior to the alternate when projected.

## COLOR LASER PRINTER GUIDE

■ - Recommended Film

3M Transparency

□ - Alternate Film

Film

Printer and Copier Model	CG3700	CG3710	CG5000
<b>Apple</b> Color Laserwriter 12/600, 12/660		■	
<b>Brother</b> HL2400C		■	
<b>Canon</b> CLBP360		■	
CLBP460, Imageclass C2100	■		
<b>Digital</b> ColorWriter LSR2000+		■	
<b>Hewlett-Packard</b>			
Color LaserJet, Color LaserJet 5, 5M	■		
Color LaserJet 4500, 8500	■		
<b>Hitachi</b> BeamStar-NW		■	
<b>IBM</b> Network Color Printer		■	
<b>Lexmark</b> OptraC		■	
SC1275			■
<b>Minolta</b> Color PageWorks		■	
<b>Okidata</b> Okipage 8C		■	
<b>Panasonic</b>			
KX-PS8000E, KX-P8410E, KX-P8475		■	
<b>QMS</b> Magicolor 2CX		■	
CX8, 20, 32, 40, 1200			■
<b>Tektronix</b> 300, 340, 350, 360, 540, 550	□		■
560, 740		■	
780	■		□
840	□		■
<b>Xerox</b> DocuColor 4LP use PP2260			
NC60, C55 use PP2500			

COLOR LASER PRINTER GUIDE

# BLACK AND WHITE COPIER TRANSPARENCY

## REFERENCE GUIDE

- - Recommended Film
- - Alternate Film

### 3M Transparency Film

Copier	3M Transparency Film				
	PP2200	PP2410	PP2500	PP2950	CG5000
<b>A.B. Dick</b>					
2018, 2025, 2035, 2045	□	□	■	□	■
2060	□	■			
7113, 7120	□	□	■	□	■
7226, 7335, 7445, 7455	□		■	□	■
7463	□	■			
7577	□	□	■	□	■
<b>Canon</b>					
C100, 120, 122, 150, 160, 180				■	■
C200D, 210, 300, 330D, 400D				■	■
GP-30F, 55/55F, 200/200F, 200E, 405		□	■	■	■
Imageclass 2200, 2210, 2220				■	■
Imagerunner 210, 330, 550, 400, 600		□	■	■	■
NP-1010, 1020, 1215, 1218		□	■	■	■
NP-1500, 1520, 1820, 2020		□	■	■	■
NP-2120, 3030, 3050, 3325		□	■	■	■
NP-3825, 4050, 4080, 4835		□	■	■	■
NP-6012/6012F, 6016, 6025		□	■	■	■
NP-6030, 6035		□	■	■	■
NP-6045, 6050, 6060		□		■	■
NP-6080, 6085		□		■	■
NP-6150, 6150II		□		■	■
NP-6221, 6230		□	■	■	■
NP-6285		□		■	■
NP-6330, 6412, 6521		□	■	■	■
NP-6545, 6551, 6560II, 6650		□		■	■
NP-7130, 7750		□	■	■	■
NP-8530		□		■	■
NP-8580, 9030, 9120, 9330	□	□	■	□	■
NP-9800	□	□		■	■
NP-9850		□	■	□	■
PC-1, 2, 11, 12, 300, 310, 325				■	■
PC-330, 400, 420, 430, 530, 550				■	■
PC-710, 720, 730, 735, 740, 745				■	■
PC-770, 775, 785, 790, 795, 850, 870				■	■
PC-920, 921, 950, 980, 981				■	■

# BLACK AND WHITE COPIER TRANSPARENCY

## REFERENCE GUIDE

- - Recommended Film
- - Alternate Film

### 3M Transparency Film

Copier	PP2200	PP2410	PP2500	PP2950	CG5000
<b>Copystar</b>					
1415, 1435, 1605, 1656	□	□	■	□	■
1685, 2013, 2014, 2017	□	□	■	□	■
2018, 2021, 2054, 2085	□	□	■	□	■
2115, 2118, 2121, 2218, 2221	□	□	■	□	■
<b>Danka</b>					
A50, A75	□	□		■	■
<b>Gestetner</b>					
2222, 2301, 2302, 2303	□	□	■	□	■
2318, 2322, 2335, 2337	□	□	■	□	■
2345, 2346, 2355, 2356	□	□	■	□	■
2417, 2418, 2423, 2425	□	□	■	□	■
2430	□	□		■	■
2440, 2460	□	□	■	□	■
2470	□	□		■	■
2480	□	□	■	□	■
2485, 2530	□	□		■	■
2533, 2545	□	□	■	□	■
2565, 2580, 2613	□	□	■	□	■
2635, 2640, 2651	□	□	■	□	■
2655	□	□		■	■
2665, 2680	□	□	■	□	■
2715, 2718, 2722, 2732, 2740	□	□	■	□	■
2760, 2770, 2822, 2850, 2851	□	□	■	□	■
2860, 2870, 2922, 3210, 3218, 3220	□	□	■	□	■
3222, 3227, 3235, 3240, 3245, 3255, 3265, 3285	□	□	■	□	■
<b>Hewlett-Packard</b>					
Mopier 240, 320				■	■
<b>Hitachi</b>					
DDC-52, 62			■	■	■
<b>IBM</b>					
III-50, 60, 70, 85	□	■			

BLACK AND WHITE COPIER TRANSPARENCY



# BLACK AND WHITE COPIER TRANSPARENCY

## REFERENCE GUIDE

- - Recommended Film
- - Alternate Film

### 3M Transparency Film

Copier	PP2200	PP2410	PP2500	PP2950	CG5000
<b>Kodak</b>					
Ektaprint™ 30		□	■	■	■
85, 90, 95		□		■	■
IM-40		□	■	□	■
ImageSource-50, 70, 85		□		■	■
ImageSource-110, 8085	□	□	■	□	■
150, 185, 220, 225	□	□	■	□	■
235, 250, 285, 300	□	□	■	□	■
1570, 1575, 1580	□	□	■	□	■
2085, 2110, 2120, 3100, 9110	□	□	■	□	■
<b>Konica</b>					
1015, 1112, 1120, 1212, 1216	□	□	■	□	■
1290RE, 1312, 2020, 2028, 2125	□	□	■	□	■
2130, 2223, 2230, 2330, 3135	□	□	■	□	■
3240, 3340, 4045	□	□	■	□	■
4065		■			
4090, 4145, 4155, 4255	□	□	■	□	■
4345, 4355, 5080, 5370	□	□	■	□	■
6090, 6090RE		■			
6190, 7033, 7040	□	□	■	□	■
+7050, 7050P		□		■	■
7060, 7065	□	□	■	□	■
7090RF, 7090S		■			
7150, 7310, 7410, 7490	□	□	■	□	■
8010, 8028	■				
<b>Lanier</b>					
3022, 5020, 5025, 5045	□	□	■	□	■
5218, 5222, 5227, 5235, 5245, 5255, 5265	□	□	■	□	■
5355, 5365, 6110, 6112	□	□	■	□	■
6230, 6260		□		■	■
6272, 6315	□	□	■	□	■
6360	□	□		■	■
6413, 6425, 6432, 6440	□	□	■	□	■
6450, 6483	□	□		■	■
6514, 6517, 6523, 6525	□	□	■	□	■

# BLACK AND WHITE COPIER TRANSPARENCY

## REFERENCE GUIDE

- - Recommended Film
- - Alternate Film

3M Transparency Film

Copier	PP2200	PP2410	PP2500	PP2950	CG5000
<b>Lanier (continued)</b>					
6532, 6540, 6583	□	□		■	■
6616, 6625, 6632, 6714	□	□	■	□	■
6716, 6717, 6720, 6725, 6735	□	□	■	□	■
6745	□	□		■	■
6755, 6765, 6775, 6838	□	□	■	□	■
7085, 7100, 7213, 7216	□	□	■	□	■
7228, 7320, 7328, 7335	□	□	■	□	■
7345, 7355, 7365	□	□	■	□	
7375	□	□		■	■
7385	□	□	■	□	■
<b>Minolta</b>					
DiALTA DI-30, 181, 250, 350, 520, 620	□	□	■	□	■
EP-1030, 1031, 1070, 1080, 1081, 1083, 1085	□	□	■	□	■
EP-1560, 1755, 1860, 2010, 2030, 2050	□	□	■	□	■
EP-2080, 2120, 2121, 2130, 2150	□	□	■	□	■
EP-2150, 2151, 2152, 2360, 3000, 3050	□	□	■	□	■
EP-3050, 3150, 3170, 3190	□	□	■	□	■
EP-4000, 4050, 4210	□	□	■	□	■
EP-4233	□	□		■	■
EP-4320, 4321, 5000, 5050, 5320	□	□	■	□	■
EP-5400, 5401				■	■
EP-5420, 6000, 6001, 8010, 8015	□	■	■	□	■
EP-8600, 8601, 8602, 8603				■	■
EP-9720		■			
EP-9760	□	□	■	□	■
<b>Mita</b>					
AC6500, AF1200	□	□	■	□	■
DC-1256, 1257, 1415, 1435	□	□	■	□	■
DC-1455, 1460, 1450, 1560	□	□	■	□	■
DC-1605, 1656, 1685, 1755	□	□	■	□	■
DC-1855, 1856, 1860, 2155	□	□	■	□	■
DC-2285, 2355, 2360, 2556	□	□	■	□	■
DC-3055, 3060		□		■	■

BLACK AND WHITE COPIER TRANSPARENCY

# BLACK AND WHITE COPIER TRANSPARENCY

## REFERENCE GUIDE

- - Recommended Film
- - Alternate Film

3M Transparency Film

Copier	PP2200	PP2410	PP2500	PP2950	CG5000
<b>Mita (continued)</b>					
DC-3555, 3585, 3755	□	□	■	□	■
DC-3785, 4056, 4086, 4090	□	□	■	□	■
DC-4585, 4655, 4685, 5090	□	□	■	□	■
DC-5555	□	□	■	□	■
DC-5585, 5590		□		■	■
DC-5685	□	□	■	□	■
DC-5690		□		■	■
DC-6070, 6080, 6090	□	□	■	□	■
DC-6590, 6595	□	□	■	□	■
DC-7085, 7090		□		■	■
DC-8090, 8095	□	□	■	□	■
DC-8585, 9285		□		■	■
PointSource AI-1515, 1555, 1810, 2020, 2310	□	□	■	□	■
PointSource AI-3010, 3030, 4040, 5050, 6060	□	□	■	□	■
<b>Monroe</b>					
RL-918, 922, 937, 946	□	□	■	□	■
RL-956, 970, 985	□	□	■	□	■
RL-970, 985		□		■	■
RL-1213, 1217, 1218, 1223, 1230	□	□	■	□	■
RL-1230		□		■	■
RL-1240	□	□	■	□	■
RL-1255	□	□		■	■
RL-1260, 1265, 1285	□	□	■	□	■
RL-1292, 1430		□		■	■
RL-1440	□	□	■	□	■
<b>OCE</b>					
1725, 1750, 1825, 1830, 1850		■			
1900, 1925, 1930, 2250, 2270		■			
2275, 2375, 2400, 2450, 2465		■			
2475, 2500, 2600, 3045, 3055		■			
3075, 3133, 3140, 3155, 3165		■			

# BLACK AND WHITE COPIER TRANSPARENCY

## REFERENCE GUIDE

- Recommended Film  
 - Alternate Film

3M Transparency Film

Copier	PP2200	PP2410	PP2500	PP2950	CG5000
<b>Panasonic</b>					
FP-D250, 350, 450, 600	<input type="checkbox"/>	<input type="checkbox"/>	<input checked="" type="checkbox"/>	<input type="checkbox"/>	<input checked="" type="checkbox"/>
FP-1270, 1275, 1680, 1780, 2080	<input type="checkbox"/>	<input type="checkbox"/>	<input checked="" type="checkbox"/>	<input type="checkbox"/>	<input checked="" type="checkbox"/>
FP-2680, 3280, 4080, 5060	<input type="checkbox"/>	<input type="checkbox"/>	<input checked="" type="checkbox"/>	<input type="checkbox"/>	<input checked="" type="checkbox"/>
FP-6070, 6080, 6090	<input type="checkbox"/>	<input type="checkbox"/>		<input checked="" type="checkbox"/>	<input checked="" type="checkbox"/>
FP-7113, 7115	<input type="checkbox"/>	<input type="checkbox"/>	<input checked="" type="checkbox"/>	<input type="checkbox"/>	<input checked="" type="checkbox"/>
FP-7117, 7121, 7127, 7132	<input type="checkbox"/>	<input type="checkbox"/>	<input checked="" type="checkbox"/>	<input type="checkbox"/>	<input checked="" type="checkbox"/>
FP-7140, 7160, 7181, 7650	<input type="checkbox"/>	<input type="checkbox"/>	<input checked="" type="checkbox"/>	<input type="checkbox"/>	<input checked="" type="checkbox"/>
FP-7713, 7715, 7718, 7722	<input type="checkbox"/>	<input type="checkbox"/>	<input checked="" type="checkbox"/>	<input type="checkbox"/>	<input checked="" type="checkbox"/>
FP-7728, 7735, 7742, 7750	<input type="checkbox"/>	<input type="checkbox"/>	<input checked="" type="checkbox"/>	<input type="checkbox"/>	<input checked="" type="checkbox"/>
FP-7760, 7781	<input type="checkbox"/>	<input type="checkbox"/>	<input checked="" type="checkbox"/>	<input type="checkbox"/>	<input checked="" type="checkbox"/>
<b>Pitney Bowes</b>					
C-140, 145, 170, 180, 230, 235, 270	<input type="checkbox"/>	<input type="checkbox"/>	<input checked="" type="checkbox"/>	<input type="checkbox"/>	<input checked="" type="checkbox"/>
C-285, 320, 350, 355, 400	<input type="checkbox"/>	<input type="checkbox"/>	<input checked="" type="checkbox"/>	<input type="checkbox"/>	<input checked="" type="checkbox"/>
C-420, 450, 480, 500, 550	<input type="checkbox"/>	<input type="checkbox"/>	<input checked="" type="checkbox"/>	<input type="checkbox"/>	<input checked="" type="checkbox"/>
C-600, 650, 760, 800, 850	<input type="checkbox"/>	<input type="checkbox"/>	<input checked="" type="checkbox"/>	<input type="checkbox"/>	<input checked="" type="checkbox"/>
C-950		<input type="checkbox"/>		<input checked="" type="checkbox"/>	<input checked="" type="checkbox"/>
D-743	<input type="checkbox"/>	<input type="checkbox"/>	<input checked="" type="checkbox"/>	<input type="checkbox"/>	<input checked="" type="checkbox"/>
DL-250, 350, 355, 450, 520, 600, 620	<input type="checkbox"/>	<input type="checkbox"/>	<input checked="" type="checkbox"/>	<input type="checkbox"/>	<input checked="" type="checkbox"/>
9014, 9016, 9023, 9032, 9035	<input type="checkbox"/>	<input type="checkbox"/>	<input checked="" type="checkbox"/>	<input type="checkbox"/>	<input checked="" type="checkbox"/>
9045, 9056	<input type="checkbox"/>	<input type="checkbox"/>	<input checked="" type="checkbox"/>	<input type="checkbox"/>	<input checked="" type="checkbox"/>
9070	<input type="checkbox"/>	<input type="checkbox"/>		<input checked="" type="checkbox"/>	<input checked="" type="checkbox"/>
9317, 9323, 9326, 9332	<input type="checkbox"/>	<input type="checkbox"/>	<input checked="" type="checkbox"/>	<input type="checkbox"/>	<input checked="" type="checkbox"/>
9337, 9340, 9346	<input type="checkbox"/>	<input type="checkbox"/>	<input checked="" type="checkbox"/>	<input type="checkbox"/>	<input checked="" type="checkbox"/>
SF-40, 50, 60, 80	<input type="checkbox"/>	<input type="checkbox"/>	<input checked="" type="checkbox"/>	<input type="checkbox"/>	<input checked="" type="checkbox"/>
<b>Ricoh</b>					
Aficio 180, 200, 220, 250, 270, 340, 350, 355	<input type="checkbox"/>	<input type="checkbox"/>	<input checked="" type="checkbox"/>	<input type="checkbox"/>	<input checked="" type="checkbox"/>
Aficio 400, 401	<input type="checkbox"/>	<input type="checkbox"/>		<input checked="" type="checkbox"/>	<input checked="" type="checkbox"/>
Aficio 450, 455	<input type="checkbox"/>	<input type="checkbox"/>	<input checked="" type="checkbox"/>	<input type="checkbox"/>	<input checked="" type="checkbox"/>
Aficio 500	<input type="checkbox"/>	<input type="checkbox"/>		<input checked="" type="checkbox"/>	<input checked="" type="checkbox"/>
Aficio 550, 650, 850	<input type="checkbox"/>	<input type="checkbox"/>	<input checked="" type="checkbox"/>	<input type="checkbox"/>	<input checked="" type="checkbox"/>
Bizworks 406DF, 706	<input type="checkbox"/>	<input type="checkbox"/>	<input checked="" type="checkbox"/>	<input type="checkbox"/>	<input checked="" type="checkbox"/>
DS-5330	<input type="checkbox"/>	<input type="checkbox"/>	<input checked="" type="checkbox"/>	<input type="checkbox"/>	<input checked="" type="checkbox"/>
FT-2012, 2212, 3013, 3513	<input type="checkbox"/>	<input type="checkbox"/>	<input checked="" type="checkbox"/>	<input type="checkbox"/>	<input checked="" type="checkbox"/>
FT-3713, 4015, 4022, 4027	<input type="checkbox"/>	<input type="checkbox"/>	<input checked="" type="checkbox"/>	<input type="checkbox"/>	<input checked="" type="checkbox"/>

BLACK AND WHITE COPIER TRANSPARENCY

# BLACK AND WHITE COPIER TRANSPARENCY

## REFERENCE GUIDE

- Recommended Film  
 - Alternate Film

3M Transparency Film

Copier	PP2200	PP2410	PP2500	PP2950	CG5000
<b>Ricoh (continued)</b>					
FT-4215, 4220, 4222, 4427	<input type="checkbox"/>	<input type="checkbox"/>	<input checked="" type="checkbox"/>	<input type="checkbox"/>	<input checked="" type="checkbox"/>
FT-4490, 4522, 4527, 4727	<input type="checkbox"/>	<input type="checkbox"/>	<input checked="" type="checkbox"/>	<input type="checkbox"/>	<input checked="" type="checkbox"/>
FT-4622, 4822, 5035, 5433	<input type="checkbox"/>	<input type="checkbox"/>	<input checked="" type="checkbox"/>	<input type="checkbox"/>	<input checked="" type="checkbox"/>
FT-5535, 5540, 5632, 5733	<input type="checkbox"/>	<input type="checkbox"/>	<input checked="" type="checkbox"/>	<input type="checkbox"/>	<input checked="" type="checkbox"/>
FT-5832, 5840, 6645, 6655	<input type="checkbox"/>	<input type="checkbox"/>	<input checked="" type="checkbox"/>	<input type="checkbox"/>	<input checked="" type="checkbox"/>
FT-6665, 6750, 7650, 7660, 7670	<input type="checkbox"/>	<input type="checkbox"/>	<input checked="" type="checkbox"/>	<input type="checkbox"/>	<input checked="" type="checkbox"/>
FT-7770, 7870		<input checked="" type="checkbox"/>			
FT-7950, 7960, 7970	<input type="checkbox"/>	<input type="checkbox"/>	<input checked="" type="checkbox"/>	<input type="checkbox"/>	<input checked="" type="checkbox"/>
FT-8680		<input checked="" type="checkbox"/>			
FT-8780, 8880	<input type="checkbox"/>	<input type="checkbox"/>	<input checked="" type="checkbox"/>	<input type="checkbox"/>	<input checked="" type="checkbox"/>
FT-8980	<input checked="" type="checkbox"/>	<input checked="" type="checkbox"/>			
FT-9101, 9105	<input type="checkbox"/>	<input type="checkbox"/>	<input checked="" type="checkbox"/>	<input type="checkbox"/>	<input checked="" type="checkbox"/>
MV-310, 715	<input type="checkbox"/>	<input type="checkbox"/>	<input checked="" type="checkbox"/>	<input type="checkbox"/>	<input checked="" type="checkbox"/>
NC-100	<input checked="" type="checkbox"/>				
NC-305	<input type="checkbox"/>	<input type="checkbox"/>	<input checked="" type="checkbox"/>	<input type="checkbox"/>	<input checked="" type="checkbox"/>
8015, 8115	<input checked="" type="checkbox"/>				
<b>Royal Copystar</b>					
1500D, 1800DF, 2000D	<input type="checkbox"/>	<input type="checkbox"/>	<input checked="" type="checkbox"/>	<input type="checkbox"/>	<input checked="" type="checkbox"/>
2030	<input type="checkbox"/>	<input type="checkbox"/>		<input checked="" type="checkbox"/>	<input checked="" type="checkbox"/>
2035, 2037, 2054	<input type="checkbox"/>	<input type="checkbox"/>	<input checked="" type="checkbox"/>	<input type="checkbox"/>	<input checked="" type="checkbox"/>
2130	<input type="checkbox"/>	<input type="checkbox"/>		<input checked="" type="checkbox"/>	<input checked="" type="checkbox"/>
2140, 2235, 2237	<input type="checkbox"/>	<input type="checkbox"/>	<input checked="" type="checkbox"/>	<input type="checkbox"/>	<input checked="" type="checkbox"/>
2245, 2246, 2250	<input type="checkbox"/>	<input type="checkbox"/>	<input checked="" type="checkbox"/>	<input type="checkbox"/>	<input checked="" type="checkbox"/>
2255	<input type="checkbox"/>	<input type="checkbox"/>		<input checked="" type="checkbox"/>	<input checked="" type="checkbox"/>
2256, 2260, 2265	<input type="checkbox"/>	<input type="checkbox"/>	<input checked="" type="checkbox"/>	<input type="checkbox"/>	<input checked="" type="checkbox"/>
2270	<input type="checkbox"/>	<input type="checkbox"/>		<input checked="" type="checkbox"/>	<input checked="" type="checkbox"/>
2280, 2310, 2325, 2340, 2365	<input type="checkbox"/>	<input type="checkbox"/>	<input checked="" type="checkbox"/>	<input type="checkbox"/>	<input checked="" type="checkbox"/>
2440, 3000D, 3010, 4000D, 5000D	<input type="checkbox"/>	<input type="checkbox"/>	<input checked="" type="checkbox"/>	<input type="checkbox"/>	<input checked="" type="checkbox"/>
<b>Sanyo</b>					
SFT-125, 126, 133	<input type="checkbox"/>	<input type="checkbox"/>	<input checked="" type="checkbox"/>	<input type="checkbox"/>	<input checked="" type="checkbox"/>
<b>Savin Dry Toner</b>					
2035, 2045, 2050, 2060, 2070, 2085	<input type="checkbox"/>	<input type="checkbox"/>	<input checked="" type="checkbox"/>	<input type="checkbox"/>	<input checked="" type="checkbox"/>
7334, 7640, 9013	<input type="checkbox"/>	<input type="checkbox"/>	<input checked="" type="checkbox"/>	<input type="checkbox"/>	<input checked="" type="checkbox"/>
9015, 9020, 9022, 9027, 9032	<input type="checkbox"/>	<input type="checkbox"/>	<input checked="" type="checkbox"/>	<input type="checkbox"/>	<input checked="" type="checkbox"/>
9035, 9080, 9110, 9113	<input type="checkbox"/>	<input type="checkbox"/>	<input checked="" type="checkbox"/>	<input type="checkbox"/>	<input checked="" type="checkbox"/>

# BLACK AND WHITE COPIER TRANSPARENCY

## REFERENCE GUIDE

- - Recommended Film
- - Alternate Film

3M Transparency Film

Copier	PP200	PP2410	PP2500	PP2950	CG5000
<b>Savin Dry Toner (continued)</b>					
9115, 9122, 9130, 9150	□	□	■	□	■
9180, 9210, 9220, 9270	□	□	■	□	■
9330, 9335, 9400, 9450	□	□	■	□	■
9500, 9520, 9550, 9600	□	□	■	□	■
9650, 9700	□	□	■	□	■
9710		■			
9800, 9910, 9915, 9918, 9920, 9922, 9927	□	□	■	□	■
9925, 9935, 9940, 9945	□	□	■	□	■
9950, 9955, 9965	□	□	■	□	■
<b>Selex</b>					
1455, 2350, 2380, 2580	□	□	■	■	■
3580, 4170, 7260	□	□	■	■	■
<b>Sharp</b>					
AL800, 840, 1000, 1010, 1020, 1041			■	□	■
AL1200, 1220, 1250, 1521, 1600, 1610			■	□	■
AL1620, 1621, 1640, 1650, 1670			■	□	■
AR-150, 151, 155, 160, 161, 200, 205, 250			■	□	■
AR-280, 285, 286, 335, 336, 405, 501, 505		□	■	□	■
AR-5125, 5132	□	□	■	□	■
SD2060, 2075, 2175, 2260	□	□	■	□	■
SD2275, 3062, 3075, 4085	□	□	■	□	■
SF2010, 2014, 2020, 2022, 2025	□	□	■	□	■
SF2027, 2030, 2035, 2040	□	□	■	□	■
SF2050, 2052, 2116, 2118	□	□	■	□	■
SF2120, 2214, 2216, 2314	□	□	■	□	■
SF2414, 2514, 2530, 2540	□	□	■	□	■
SF7320, 7370	□	□	■	□	■
SF7800, 7850, 7855, 7900		■			
SF8300, 8350, 8400, 8570		■			
SF8585, 8870, 8875, 9100		■			
SF9400, 9800		■			
SN1430	□	□	■	□	■

BLACK AND WHITE COPIER TRANSPARENCY

# BLACK AND WHITE COPIER TRANSPARENCY

## REFERENCE GUIDE

- - Recommended Film
- - Alternate Film

3M Transparency Film

Copier	PP2200	PP2410	PP2500	PP2950	CG5000
<b>Toshiba</b>					
BD3910, 4910, 5120, 7910	□	□	■	□	■
DP-1250, 1450, 1570, 2460, 3580, 4580	□	□	■	□	■
DP-5570, 6570	□	□	■	□	■
1210	□	□	■	□	■
1360, 1370, 1550, 1560	□	□	■	□	■
1650, 1710, 2050, 2060, 2230	□	□	■	□	■
2310, 2500, 2510, 2532, 2540	□	□	■	□	■
2550, 2570, 2860, 3210, 3550, 3560	□	□	■	□	■
3220	□	□		■	■
3550, 3560	□	□	■	□	■
4010, 4550	□	□		■	■
4560	□	□	■	□	■
5010, 5020	□	□		■	■
5540, 5560, 5570, 6550, 6560, 6570	□	□	■	□	■
7110	□	■			
7550, 7560	□	□	■	□	■
7560, 7910	□	□		■	■
8550, 9050, 9060	□	□	■	□	■
9230, 9240	□	□		■	■
<b>Xerox</b>					
XC23, 33, 355, 356, 540			■		■
XC580, 820, 830, 865			■		■
XC1020, 1040, 1044, 1045, 1255			■	□	■
XC1875, 2675	□	□	■	□	■
1012, 1025, 1038, 1040	□	□	■	□	■
1045, 1048, 1050, 1065	□	□	■	□	■
1075, 1090	■	■			
5009, 5011			■	□	■
5016, 5018, 5021	□	□	■	□	■
5028, 5034, 5035, 5042		□	■	□	■
5046		□	■	□	■
5050, 5052, 5053		□		■	■
5090	■	■			
5100	□	□	■	□	■

# BLACK AND WHITE COPIER TRANSPARENCY

## REFERENCE GUIDE

- - Recommended Film
- - Alternate Film

3M Transparency Film

Copier	PP200	PP2410	PP2500	PP2950	CG5000
<b>Xerox (continued)</b>					
5113, 5114, 5126	□		■	□	■
5201, 5203, 5205, 5210, 5220			■	□	■
5240, 5260	□		■	□	■
5305, 5306, 5308, 5309, 5310			■	□	■
5312, 5313, 5314, 5318, 5320	□	□	■	□	■
5322, 5328, 5334, 5335, 5337	□	□	■	□	■
5340, 5343, 5345, 5350, 5352C	□	□	■	□	■
5343, 5345, 5355, 5365	□	□		■	■
5365	□	□	■	□	■
5380, 5385, 5388, 5390	■	■			
5614ZSD, 5624, 5626			■	□	■
5665SF, 5665SS	□	□	■	□	■
5680, 5690	■	■			
5800, 5818, 5820, 5828, 5830	□	□	■	□	■
5837, 5845, 5855, 5885, 5890	□	□	■	□	■
5892	■	■			
5895	□	□	■	□	■
9500, 9900, 9950	■	■			
Document Centre System 20, 35	□	□	■	□	■
Document Centre 220, 230, 240, 255, 265, 332, 340	■	□	■	□	■
Doculink 5690	■	■			
DocuTech 90, 135, 6135, 6180	■	■			
System 20 copier/fax	□	□	■	□	■
XD-100, 102, 103, 105, 120, 155				■	■
XDL-23, 33/33D				■	■
WorkCentre XE-60/62, 80/82				■	■

BLACK AND WHITE COPIER TRANSPARENCY

The image quality of the recommended product is superior to the alternate when projected.



# BLACK AND WHITE TRANSPARENCY FILM

## 3M Transparency Film

Transparency Compatibility for Black & White Laser Printers	Film	
	CG3300	CG3360
Apple	■	■
Brother	■	■
Canon	■	■
Hewlett-Packard	■	■
Hitachi	■	■
IBM	■	■
Lexmark	■	■
Minolta	■	■
NEC	■	■
OCE	■	■
Okidata	■	■
Panasonic	■	■
QMS	■	■
Ricoh	■	■
Sharp	■	■
Unisys	■	■
Xerox	■	■

<b>Laser Printer Films</b> <b>For Black &amp; White Laser Printers</b> 8-1/2" x 11" (215mm x 279mm) Water-Based Coating - 99% Solvent-Free CG3360 is Paper-Backed - attached on the 8-1/2" side				
Product Number	Color	Sheets/Bx Box/Ctn	Stock #	UPC #
CG3300	Clear	50/5	78-6969-7043-9	051125-01866-1
CG3300/20	Clear	20/10	78-6969-8563-5	051125-07332-5
CG3360	Clear	50/5	78-6969-7460-5	051125-07375-2
CG5000	Clear	50/5	78-6969-8241-8	051125-58774-7
CG5000/20	Clear	20/10	78-6969-8240-0	051125-58773-0
701 Highland	Clear	50/5	78-6969-8593-2	051125-58392-3

**Note:** CG3300 and CG5000 are recommended for most black and white laser printers. CG5000 is also used in some color laser printers. Refer to the Black and White Copier Transparency Guide for recommendations.



# COMPUTER GRAPHICS FILM REFERENCE GUIDE

## Ink Jet Printers

CG3480 is a universal ink jet film designed to work in most ink jet printers.

## 3M Transparency Film

■ - recommended    □ - alternative

	CG3410	CG3460	CG3480
<b>Apollo</b>			
P-1200, P-1220		■	□
<b>Apple</b>			
StyleWriter II, StyleWriter Pro, 1200, 1500, 2400, 2500	■		□
Color Printer	□		■
Apple Color StyleWriter 4100, 4500, 6500		■	□
<b>Brother</b>			
HC2500, MFC7000, 7050C, 7150, 7160, 7200FC, MP21C, MP21Cdx	■		□
<b>Canon</b>			
BJ-10e, BJ-10sx, BJ-200, BJ-300	□		■
BJ-800, BJ-820	□		■
BJC-50, 70, 80, 210, 240, 250	■		□
BJC-600, 1000, 2000, 4000, 5000, 6000, 7000, 8000 Series	■		□
BN-22, Note Jet	□		■
CJ-10		■	□
FP-510	□		■
MultiPass C530, C635, 2000, 3000, 5000, 6000 Series	■		□
<b>Citizen</b>			
Projet IIC		□	■
<b>Compaq</b>			
IJ200, IJ300, IJ750, IJ900		□	■
A900 Multifunction		□	■
<b>DEC</b>			
Deckwriter 120i, 520i		□	■
<b>Digital Equipment</b>			
LJ250/LJ252		□	■
<b>Eastman Kodak</b>			
MT92C		□	■
<b>Epson</b>			
Letterjet HS 80, SQ2000-2500		□	■
Stylus Color, Stylus Color II, Stylus Color IIs, 1160, 1520, 3000	■		□
Stylus Scan 2000, 2500, 2500 Pro	■		□
Stylus Color 400, 500, 600, 700, 800, 900 Series	■		□
Stylus Color Pro, Stylus Photo, Stylus Photo 1200	■		□

# COMPUTER GRAPHICS FILM REFERENCE GUIDE

## Ink Jet Printers (continued)

## 3M Transparency Film

CG3480 is a universal ink jet film designed to work in most ink jet printers.	CG3410	CG3460	CG3480
■ - recommended    □ - alternative			
<b>Hewlett-Packard</b>			
All in one, OfficeJet R40, R60, R80, T45, T45xi, T65, T65xi		■	□
Color Copier 100, 200 Series		■	□
Copyjet, Copyjet M		■	□
Hewlett-Packard PhotoSmart, PhotoSmart P1100		■	□
DeskJet, DeskJet Plus		□	■
DeskJet 300, 400 Series		■	□
DeskJet 500 Series (black & white)		□	■
DeskJet 500 Series (color)		■	□
DesignJet 650C		□	■
DeskJet 600 Series (color)		■	□
DeskJet 700 Series (color)		■	□
DeskJet 800 Series (color)		■	□
DeskJet 900 Series (color)		■	□
DeskJet Portable		■	□
DeskJet 1000/1100 Series, 1200 Series, 1600 Series		■	□
HP 2000C, 2500 Series		■	□
OfficeJet/OfficeJet Pro 300, 500, 600, 700, 1100 Series		■	□
Printer/Scanner copier 300 Series		■	□
PaintJet, PaintWriter XL		□	■
PaintJet XL, PaintWriter XL			
PaintJet XL300		■	□
PSC 500		■	□
ThinkJet, QuietJet		□	■
All DeskWriters		■	□
<b>Houston Instrument</b>			
Jet Pro 360		□	■
<b>IBM/Lexmark</b>			
1000, 2000, 3000, 5700, 7000 Series		□	■
Execjet, Execjet IIC (4076)		□	■
Optra color 40, 40N, 45, 45N		□	■
Quietwriter		□	■
4079, 4079+		□	■
Winwriter 150C		□	■
Z11, Z31, Z51		□	■
<b>Kodak</b>			
PM100		□	■
<b>Mannesmann Tally</b>			
MT 92C		□	■

# COMPUTER GRAPHICS FILM REFERENCE GUIDE

## Ink Jet Printers (continued)

CG3480 is a universal ink jet

3M Transparency Film

film designed to work in most ink jet printers.

■ - recommended    □ - alternative

	CG3410	CG3460	CG3480
<b>NEC</b>			
SuperScript 100C, 150C, 650C, 750C, 950C		■	□
<b>Okidata</b>			
OKIJET 2020, 2050, 2500		□	■
<b>Tektronix</b>			
Phaser 140		■	□
Phaser 300 Series (solid ink) (Use CG5000)			
<b>Texas Instruments</b>			
MicroMarc Color		□	■
<b>Xerox</b>			
XJ4C, XJ6C, XJ8C, XJ9C		□	■
Document WorkCentre 450C, 450CP, 470CX, 480CX, xi70C		□	■
DocuPrint C8, C11, C15, C20		□	■
Document HomeCentre		□	■
Multi Function NC-20		□	■

## THERMAL TRANSFER PRINTER FILM

	<b>CG3650</b>
<b>Thermal Transfer Printers</b>	
<b>Calcomp</b>	
Plotmaster, Colormaster (PP2410)	■
<b>DEC</b>	
Colorwriter 1000	■
<b>General Parametrics</b>	
Spectrastar GT	■
Spectrastar 410	■
Spectrastar 420, 430, 440, 450	■
<b>Seiko Instruments</b>	
Personal Colorpoint PSX Model 4	■
<b>Tektronix</b>	
200, 220, 240 Series	■
Phaser II DX, DXN, PX, PXE	■
Phaser II PXI, PXN, PXS	■
Phaser II PXV, SX, RGB	■
RGB II 4693 D/DX, CP	■
CPS, 4694 PX	■
<b>Lanier</b>	
4230 HD	■
4600	■

### WRITE-ON FILM

<b>WRITE-ON FILM (Sheets)</b>			
<b>Used to Write-on with Transparency Pens</b>			
Clear - 8-1/2" x 10-1/2" (215mm x 266mm)			
Colored - 8-1/2" x 10-1/2" (215mm x 266mm)			
2.3 Mils - Clear, 1.8 Mils - Colors			
100 Sheets per Box			
AF4300	Clear	78-6969-7071-0	051125-01858-6

<b>WRITE-ON FILM (Rolls)</b>			
<b>Used on Overhead Projector Roll Attachments</b>			
50 ft. (15.2m)			
2.3 Mils			
Product Number	Roll Width	Stock Number	UPC Number
AF4310	10-1/4" wide	78-9020-1282-8	051125-07237-3
AF4311	11-1/4" wide	78-6969-1751-3	051125-07238-0

THERMAL TRANSFER PRINTER FILM

## RELATED PRODUCTS

<b>TRANSPARENCY FRAMES</b>				
Product Number	Type	Pkg.	Stock Number	UPC Number
RS7109	Transp. Sleeve	50	78-6969-7778-0	051125-58028-1
RS7109/20	Transp. Sleeve	20	78-6969-8397-8	051125-58973-4
RS7110	Flip Frames	50	78-6969-7128-8	051125-01970-5
RS7110/20	Flip Frames	20	78-6969-7458-9	051125-07368-4
RS7110/100	Flip Frames	100	78-6969-7834-1	051125-58140-0
RS7114	Preview Frames	50	78-6969-7981-0	051125-58254-1
RS7114/20	Preview Frames	20	78-6969-7980-2	051125-58353-4
RS7120	Cardboard w /Box	50	78-6969-7131-2	051125-01972-9
Highland 7130	Cardboard	50	78-6969-8159-2	051125-58692-4

<b>LENS CLEANER</b> For Overhead Projector Lenses			
676	1 ea	70-0705-6877-2	500-21200-71694-7

<b>TRANSPARENCY MARKING PENS</b> one each of Green, Blue, Red, Purple and Black		
RS6279	Transparency Marking Pens-Non Perm (5 pk)	78-6969-7099-1
RS6169	Transparency Marking Pens-Permanent (5 pk)	78-6969-7092-6

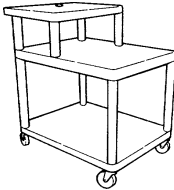
<b>OVERHEAD PRESENTERS CART</b> Universal											
	<table border="1" style="width: 100%; border-collapse: collapse;"> <thead> <tr> <th style="width: 50%; text-align: center;">Cart</th> <th style="width: 50%; text-align: center;">Top Shelf</th> </tr> </thead> <tbody> <tr> <td>Width 24"</td> <td>Width 16"</td> </tr> <tr> <td>Height 35"</td> <td>Height 8"</td> </tr> <tr> <td>Length 32"</td> <td>Length 24"</td> </tr> <tr> <td colspan="2" style="text-align: center;">Cart Weight 85 lbs.</td> </tr> </tbody> </table>	Cart	Top Shelf	Width 24"	Width 16"	Height 35"	Height 8"	Length 32"	Length 24"	Cart Weight 85 lbs.	
Cart	Top Shelf										
Width 24"	Width 16"										
Height 35"	Height 8"										
Length 32"	Length 24"										
Cart Weight 85 lbs.											
HA5651	<table border="1" style="width: 100%; border-collapse: collapse;"> <tr> <td style="width: 50%; text-align: center;">78-6969-7217-9</td> <td style="width: 50%; text-align: center;">051125-07144-4</td> </tr> </table>	78-6969-7217-9	051125-07144-4								
78-6969-7217-9	051125-07144-4										

## GLOSSARY OF OVERHEAD PROJECTOR TERMS

**APERTURE** - The area of the stage that is available for projecting an image. Usually comes in the following sizes: 10" X 10", 10.5" X 10.5" and 11.25" X 11.25" (A4).

**ARTICULATED HEAD** - A closed projector head where the mirror will move one-half the distance when the image is tilted up on the screen.

**COATED STAGE** - Hard coating on a reflective optical stage (fresnel lens) that resists scratching, so that the projected visuals stay sharp and clear.

**COLOR TUNING** - Adjusts the edge-to-edge uniformity of the projected light to eliminate yellow or blue corners. This gives an optimized image, no matter what the projector to screen distance, within the prescribed area.

**CONVECTION COOLED** - Natural cooling of the projector lamp by the upward flow of heated air, without the use of a fan. Usually used in reflective type projectors that have the lamp in the head assembly.

**DOUBLET HEAD** - A projector head that has a two element lens.

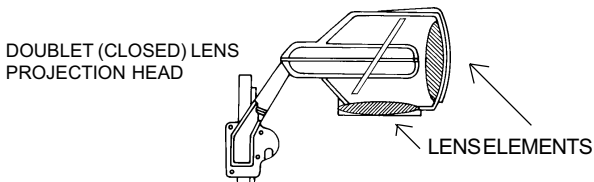

**ELEVATION ANGLE** - The elevation that the projected image can be tilted up to, and still project a full image onto the screen.

**FOCAL LENGTH** - The value given to a lens, stated in inches or millimeters. The smaller the focal length, the wider the angle of the image. Focal length is the distance between the lens and its focal point.

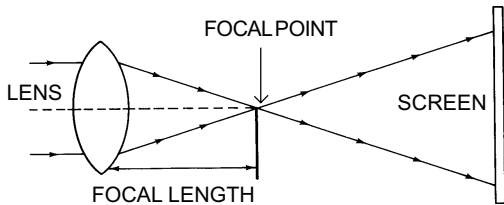

**FOCUS CORRECTION** - A feature that is used when it is necessary to project an image onto a vertical surface (such as a wall) with a high tilt angle of the head, making it possible to obtain uniform focus from top to bottom of the image. This feature does not eliminate keystoneing.

**FRESNEL LENS** - A flat lens that is composed of a series of closely spaced grooves that control the refraction of light. It is usually part of the stage.

**ILLUMINATION** - The density of light projected onto a screen or other surface. Stated in lumens.

**KEYSTONING** - Keystoneing is caused when the projected image is not perpendicular to the screen. Correct keystoneing by tilting the screen until it is perpendicular to the light beam axis. See illustration on the next page. *(Continued)*



# GLOSSARY OF OVERHEAD PROJECTOR TERMS

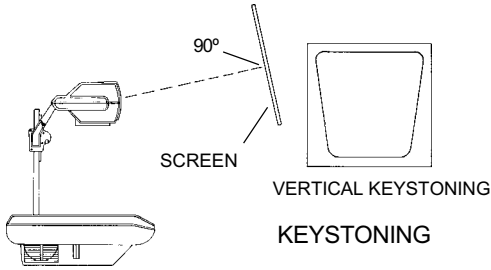

**LET RUN THERMOSTAT** - See Post Cool Thermostat.

**LIQUID CRYSTAL DISPLAY (LCD)** - A display panel that sits on top of the projector stage which creates an image that is generated by a computer.

**LUMEN** - The unit of illumination on a screen or other surface. One Lumen is the light of one candle power on each square foot of a surface of a sphere at a radius of one foot from the light source.

**OPEN HEAD** - A projection head where the mirror and lens is not enclosed. The image is raised on the screen by tilting the mirror up.

**OPTICAL TUNING** - See Color Tuning.

**OVERHEAT THERMOSTAT** - Turns the lamp off if the projector reaches an unsafe temperature.

**POST COOL THERMOSTAT** - A thermostat that allows the projector fan to continue to run after the lamp has been turned off, which reduces the temperature of the unit.

**REFLECTIVE TYPE PROJECTOR** - An overhead projector where the light source is located in the head assembly and shines down onto the stage. The light is then reflected from the fresnel lens, back through the head and onto the screen. Usually used in light weight, portable projectors.

**SINGLET HEAD** - A projector head with a lens that has only one element.

**STAGE** - The flat area of the projector where the transparency film is placed.

**SAFETY THERMOSTAT** - See overheat thermostat.

**TRANSMISSIVE TYPE PROJECTOR** - An overhead projector where the light source is under the stage and light is transmitted through the transparency film to the head and onto the screen.

**TRIPLET LENS** - A projection lens that has three elements contained in a single assembly.

TRIPLET (OPEN) LENS  
PROJECTION HEAD

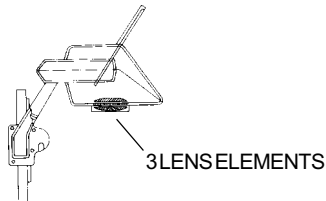

**VARIFOCAL LENS** - A projection lens containing movable elements to permit focusing of the image. (Not a zoom)

**WIDE ANGLE LENS** - A lens that will project a larger image on a screen at a closer distance than a standard lens will project. Usually has a focal length of 11.5" (293mm) or smaller.

## GLOSSARY OF EPS TERMS

**Active Matrix** - Each pixel is actively controlled by a diode or a transistor. Advantage; allows for each pixel to be independently controlled. Disadvantage; the controller does not allow for light to be transmitted through it (e.g. TFT).

**Aspect Ratio** - The ratio between the width and height of the output (whether it is a monitor, LCD panel, overhead or slide).

**Contrast Ratio** - The ratio of the brightest and darkest images a display can reproduce.

**Hz, (KHz, MHz)** - Hertz or (Kilohertz or Megahertz). Cycles per second. (Kilo = 1000, Mega = 1 million). These terms are used to express the frequency of an electrical signal or event.

**Interlaced** - Every other line is scanned during each total vertical (full) screen refresh.

**LCD** - Liquid Crystal Display panel.

**Non-Interlaced** - Each line is scanned during each total vertical (full) screen refresh.

**Passive Matrix** - Pixels are controlled by the electronics on the side of the LCD plate in a row and column format.

**Pixel** - A unique position on a display that consists of a single dot or group of three dots (red, green and blue). Total pixels are usually expressed in horizontal x vertical dimensions (e.g. 1024 x 768) XGA.

**Refresh Rate** - The number of times the screen image is "painted" or refreshed per second, expressed in Hz.

**Resolution** - The number of pixels.

**Super VGA (SVGA)** - A graphic of 800 x 600. This standard has versions with different vertical frequencies.

**TFT** - Thin Film Transistor. This is a developing technology that attempts to place the controller of the panel directly on the surface of the glass.

**Transmissivity** - The percent of the light that is transmitted off the stage of the overhead projector that reaches the screen at a given distance. Typically, LCD panels are able to use less than 10% of the total light available.

## GLOSSARY OF EPS TERMS (Cont.)

**VESA** - Video Electronics Standards Association. A non-profit group of companies organized to define and improve computer graphics standards.

**VESA Standard** - A set of display specifications agreed upon by the VESA organization, usually referred to by resolution and vertical refresh rate.

**VGA** - Video Graphics Array. This is the standard interface for the IBM PS/2. It is the only analog graphics card IBM has used (other cards handle digital information) 720 x 400 in the text mode, graphics mode 640 x 480 resolution.

**Video** - The capability to project images from a VCR, Laser Disc, or PC using a CD-ROM Drive.

**Virtual Mouse** - 3M's lightweight remote control offers all of the functionality of a Microsoft compatible serial PC mouse.

**XGA** - Extended Graphics Adapter. IBM's graphics standard that includes VGA and extended resolution up to 1024 x 768.

## GLOSSARY OF COMPUTER PRINTER TYPES

**Bubble-Jet Printers** - Canon's name for their Ink-Jet Printers.

**Dot-Matrix/Impact Printers** - Dot Matrix/Impact printers print information by printing characters one at a time by pressing the ends of selected wires against an inked ribbon and paper or film.

**Ink-Jet Printers** - Ink-Jet printers convert digital information from the computer into minute droplets of ink that are sprayed onto a sheet of paper or film.

**Laser Printers** - Laser printers convert information into images using a laser to write on a photosensitive drum. The sensitized drum picks up toner and transfers it to a sheet of paper or film, much like a plain-paper copy machine.

**Pen Plotters** - Pen plotters convert digital information from the computer into images by drawing on a sheet of paper or film with a pen or pens.

**Thermal Transfer Printers** - Thermal Transfer printers convert digital information into images using thermal transfer inks and dyes. The color dyes are thermally transferred to a receptor sheet of paper or film, or melted wax containing ink is thermally transferred to a receptor sheet.

## GLOSSARY OF INK JET TERMS

**A4 Size Product** - A4 size is normally used as the equivalent to letter size - 8 1/2" x 11" (210mm x 297mm).

**Blocking** - The occurrence of transparencies sticking together after imaging and dropping into the exit tray of the printer. May also occur when placed into protective sleeve or flip frame. The image adheres to or transfers ink to other products coming into contact with the final product. This normally occurs immediately after imaging or shortly thereafter.

**Coalescence** - The ability for the inks to flow within a coating structure such as to provide a uniform, consistent image or text.

**Color Density** - Specific value measuring intensity of color.

**Dry Time** - The amount of time taken for an image to dry to the touch.

**DPI** - Dots per inch. The number of dots placed in one square inch of material area.

**Extended Format** - Any product larger in size than the typical 8 1/2" x 11" (U.S.) letter size. In many countries outside the U.S., metric measurements of 210mm x 297mm depict letter size.

**Mono-Chrome** - In ink jet printing, normally used to describe black printing or imaging.

**Mudcracking** - The appearance of cracked or inconsistent image areas most often seen in the pigmented black regions. Similar to the cracking of dry mud.

**Print Mode** - Setting within the printers driver options which dictates a variety of different printing options (i.e., plain paper, transparency film, glossy paper, photographic, etc.).

**Process Color** - Color or image produced by combining Cyan, Magenta and Yellow.



**Visual Systems Division**

3M Austin Center  
Building A145-5N-01  
Austin, TX 78726-9000  
800-328-1371

**3M Canada, Inc.**

P.O. Box 5757  
London, Ontario  
Canada N6A-4T1  
519-451-2500